



Series
EPXB

Insert
for 3 pin contacts
with polarization B.

Issue:
Jan. 30,01

Page
1 / 1

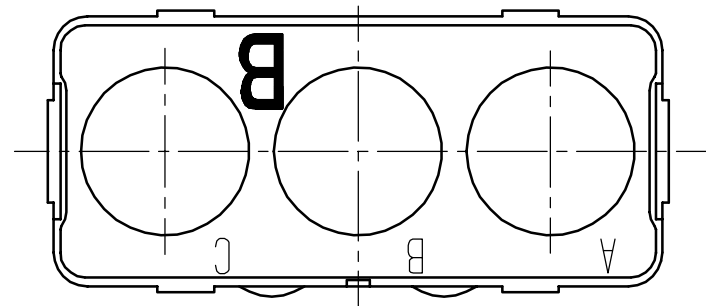
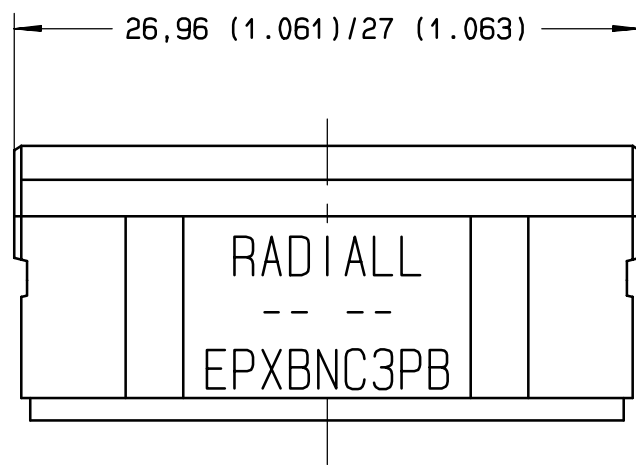
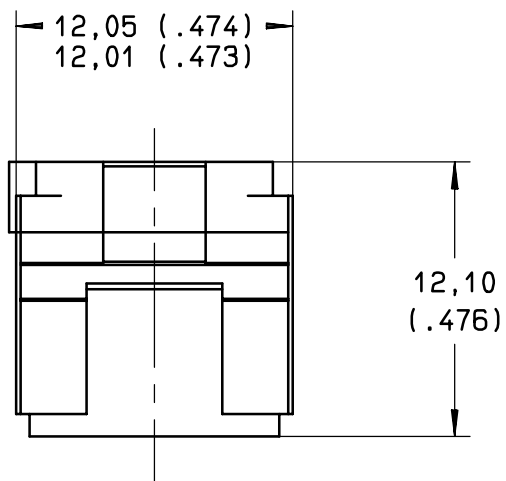
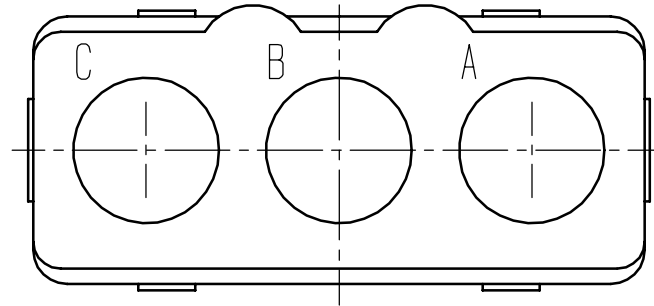

Materials:

Thermosetting fiberglass filled per ASTM D 5948-96, with metallic retention clips per ASTM-B-194.

Temperature range: -65°C +175°C (-85°F +347°F).

DIMENSIONS: mm(inch) -

This information is given as an indication. In the continual goal to improve our products, we reserve the right to make any modifications judged necessary.

4112-9610

CREATION				
PEN:				
NOM: G.Chevreau				
DATE: Jan. 30,01				
APPR.: G.Motteau				
Issue	Revisions	Name	Approved	