

## ES2A-HF Thru. ES2J-HF

Reverse Voltage: 50 to 600 Volts

Forward Current: 2 Amp

RoHS Device

Halogen Free

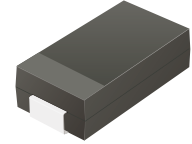

### Features

- For surface mounted applications.
- Low profile package.
- Glass passivated chip junction.
- Super fast reverse recovery time.

### Mechanical data

- Case: SMA
- Terminals: Solderable per MIL-STD-750, method 2026.

### Circuit Diagram

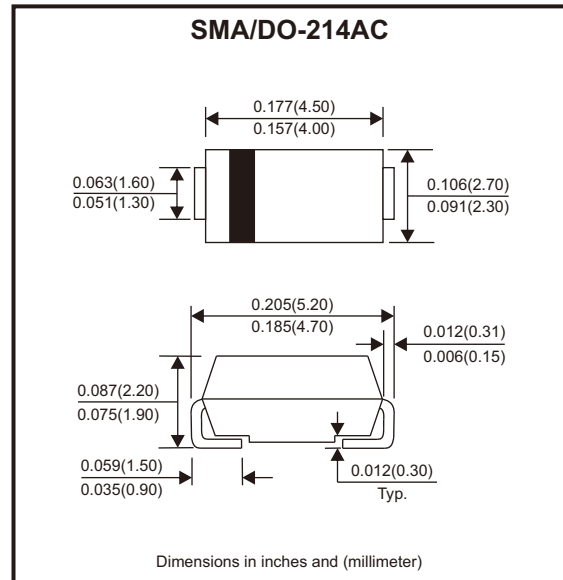

### Maximum Ratings and Electrical Characteristics

Ratings at 25°C ambient temperature unless otherwise specified.  
Single phase, half wave, 60Hz resistive or inductive load, for capacitive load, derate by 20%

Parameter	Symbols	ES2A -HF	ES2B -HF	ES2C -HF	ES2D -HF	ES2E -HF	ES2G -HF	ES2J -HF	Units
Maximum repetitive peak reverse voltage	$V_{RRM}$	50	100	150	200	300	400	600	V
Maximum RMS voltage	$V_{RMS}$	35	70	105	140	210	280	420	V
Maximum DC blocking voltage	$V_{DC}$	50	100	150	200	300	400	600	V
Maximum average forward rectified current at $T_c = 125^\circ\text{C}$	$I_{F(AV)}$	2							A
Peak forward surge current, 8.3ms single half sine-wave superimposed on rated load	$I_{FSM}$	50							A
Max. forward voltage at 2A	$V_F$	1.0			1.25		1.68		V
Maximum DC reverse current at rated DC blocking voltage $T_a = 25^\circ\text{C}$ $T_a = 125^\circ\text{C}$	$I_R$	5 100							$\mu\text{A}$
Typical junction capacitance at $V_R = 4\text{V}$ , $f = 1\text{MHz}$	$C_j$	40							pF
Maximum reverse recovery time (Note 1)	$t_{rr}$	35							ns
Typical thermal resistance (Note 2)	$R_{\theta JA}$	60							$^\circ\text{C/W}$
Operating and storage temperature range	$T_j, T_{stg}$	-55 ~ +150							$^\circ\text{C}$

Notes: 1. Measured with  $I_F = 0.5\text{A}$ ,  $I_R = 1\text{A}$ ,  $I_{rr} = 0.25\text{A}$ .  
2. P.C.B. mounted with 1.0 x 1.0" (2.54 x 2.54 cm) copper pad areas.

Company reserves the right to improve product design, functions and reliability without notice.

REV:A

## Rating and Characteristic Curves (ES2A-HF Thru. ES2J-HF)

Fig.1 - Max. Average Forward Current Rating

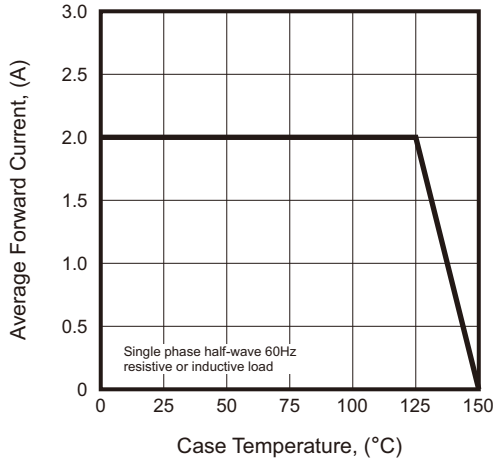

Fig.2 - Typical Reverse Characteristics

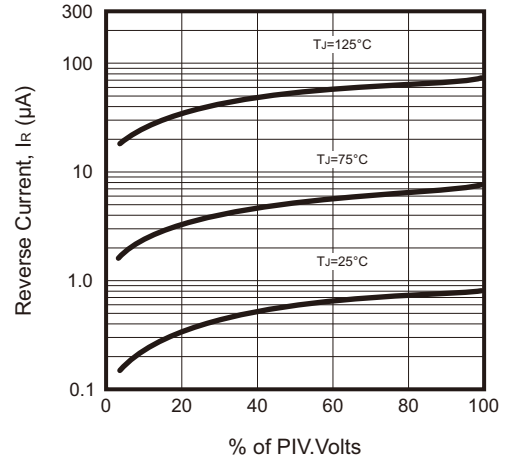

Fig.3 - Typical Forward Characteristic

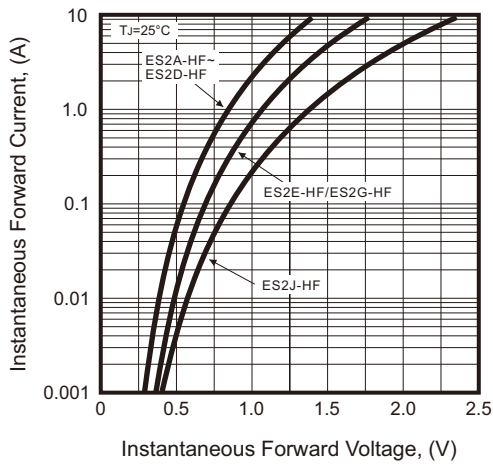

Fig.4 - Typical Junction Capacitance

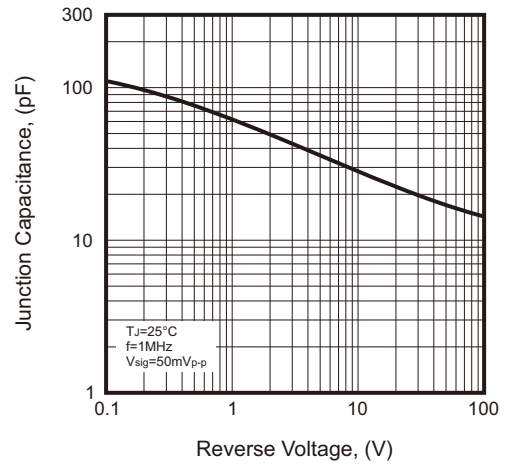
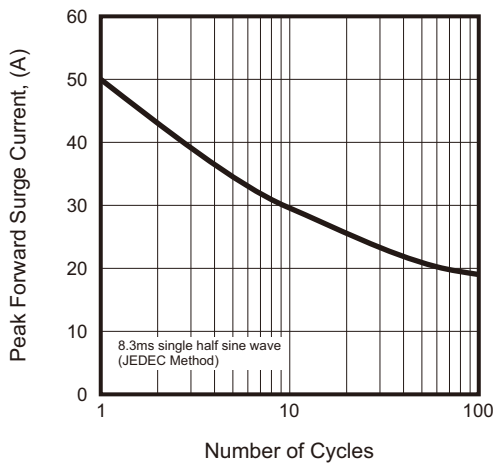
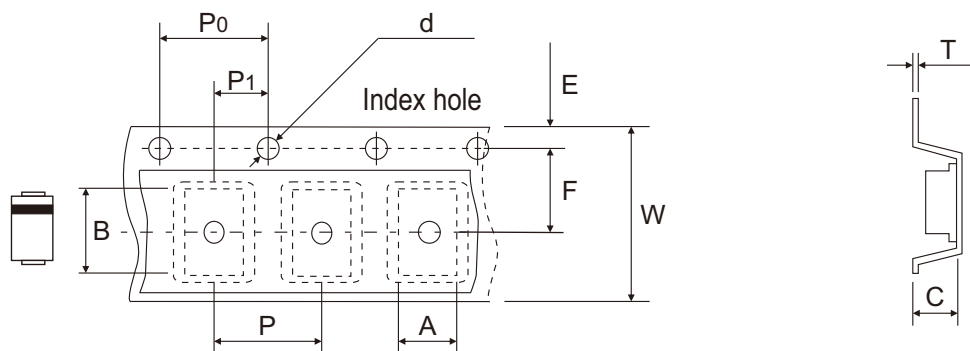

Fig.5 - Maximum Non-Repetitive Peak Forward Surge Current



Company reserves the right to improve product design, functions and reliability without notice.

## Reel Taping Specification



DO-214AC (SMA)	SYMBOL	A	B	C	d	D	D1	D2
	(mm)	2.70 ± 0.10	5.33 ± 0.10	2.35 ± 0.10	1.55 ± 0.05	330 ± 2.00	75.00 ± 1.00	13.00 ± 0.20
	(inch)	0.106 ± 0.004	0.210 ± 0.004	0.093 ± 0.004	0.061 ± 0.002	12.992 ± 0.079	2.953 ± 0.039	0.512 ± 0.008

DO-214AC (SMA)	SYMBOL	E	F	P	P0	P1	T	W	W1
	(mm)	1.75 ± 0.10	5.50 ± 0.05	4.00 ± 0.10	4.00 ± 0.10	2.00 ± 0.10	0.20 ± 0.03	12.00 ± 0.30	14.70 + 2.00 - 1.00
	(inch)	0.069 ± 0.004	0.217 ± 0.002	0.157 ± 0.004	0.157 ± 0.004	0.079 ± 0.004	0.008 ± 0.001	0.472 ± 0.012	0.579 + 0.079 - 0.039

Company reserves the right to improve product design, functions and reliability without notice.

REV:A