

# ESD-R-NC Toroidal Nanocrystal Cores for Round Cables for Low & High Frequency (with case & with fixing base)

## Overview

The KEMET ESD-R-NC Series solid toroidal cores are designed for use on round cables. KEMET's nanocrystal material allows effective noise suppression in a wide frequency range, which is an impressive solution for any conducted or radiated noise in the kHz to MHz regions. The base type allows fixing the core in the application to avoid contact with other components or stabilizing the cables, and in addition the base's structure can connect the cores together for make it even easier to install.

EMI cores are part of a family of passive components which address the issues of noise or electromagnetic interference (EMI) in circuits or systems.

## Applications

- General purpose inverters
- HVAC
- Air conditioners
- Power conditioners
- Industrial equipment
- Business multifunction printers

## Benefits

- Wide frequency range
- Solid construction
- From small to large diameter ring type
- Wide operating temperature range from  $-40^{\circ}\text{C}$  to  $+120^{\circ}\text{C}$  for standard type and  $-40^{\circ}\text{C}$  to  $+130^{\circ}\text{C}$  for base type
- UL94 V-0 flame retardant rated case
- Easy to install the with fixing base type with two screws

Standard Case Type



With Fixing Base Type



## Part Number System

| ESD-   | R-         | 291216H-                           | NC            | 23                     | -BT  |
|--------|------------|------------------------------------|---------------|------------------------|--|
| Series | Shape Type | Core Size<br>OD & ID & T Code (mm) | Core Material | Material Specification | Type   |
| ESD-   | Ring       | See Table 1                        | Nanocrystal   | 21<br>23               | Blank = Standard case<br>BT = With fixing base |

## Turns and Impedance Characteristics

When the desired performance of an EMI core cannot be obtained with a single pass through the core, the impedance characteristics can be changed with multiple turns.

A turn is counted by the number of lead-wire windings which pass through the inner hole of the core. Windings on the outside of the core do not count.

See Figure 1 for examples of one, two, and three turns.

Adding turns will result in higher impedance while also lowering the effective frequency range.

See Figure 2 for an example.

## Core Material and Effective Frequency Range

The Nanocrystal core material is typically effective for frequencies in the broadband range. See Figure 3.

It is recommended to measure the actual frequency range effectiveness in the target application.

Figure 1 – How to count turns

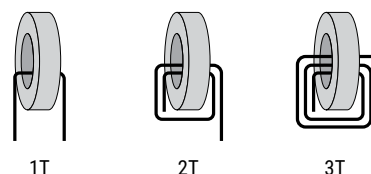

Figure 2 – Relationship between impedance and turn count. (Representative example: ESD-R-16C)

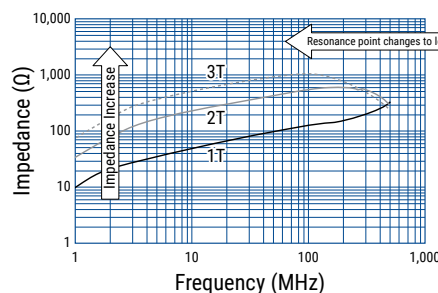
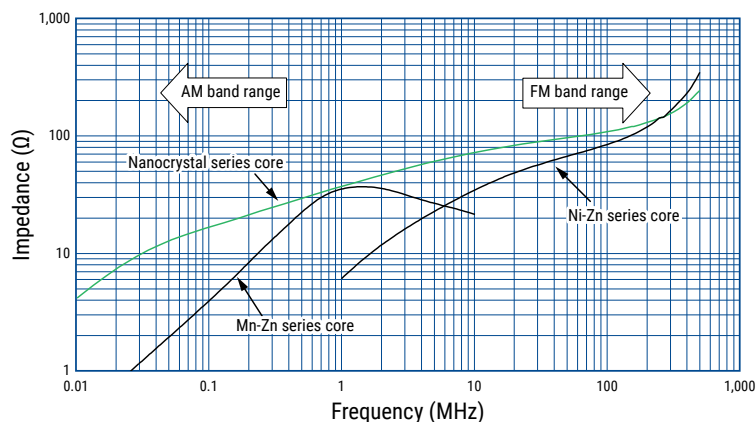

Figure 3 - Effective band range of Nanocrystal core material. (Representative example, measured with same-dimension ring core)



## Magnetic Permeability of Ferrite Material

In order to achieve most efficient noise reduction, it is important to select the material according to the target frequency band. Depending on its magnetic permeability, a particular ferrite material or metal material will be effective in a certain frequency band. A schematic representation of the relationship between the magnetic permeability of each material and the corresponding effective band range is shown in Figure 4.

Ferrite materials with higher magnetic permeability are effective in the lower frequency range, while those with lower magnetic permeability are effective in the higher frequency range. Thus, Mn-Zn products are mainly used for reducing conduction noise, while Ni-Zn products are commonly used for radiation noise countermeasures. Metal materials on the other hand are effective throughout the broadband frequency range, in low as well as high frequencies.

The effective frequency range varies depending on core shape, size and number of turns. This frequency dependence of the magnetic permeability as shown in the figure serves for reference purposes only and it should be tested on the actual device to determine its effectiveness.

S18H, S15H, 10H, 7H, 5H, 1400L and 700L are KEMET’s proprietary ferrite material names. Other materials can also be available on request.

Figure 4 - Relationship between the magnetic permeability of each material and its effective frequency range

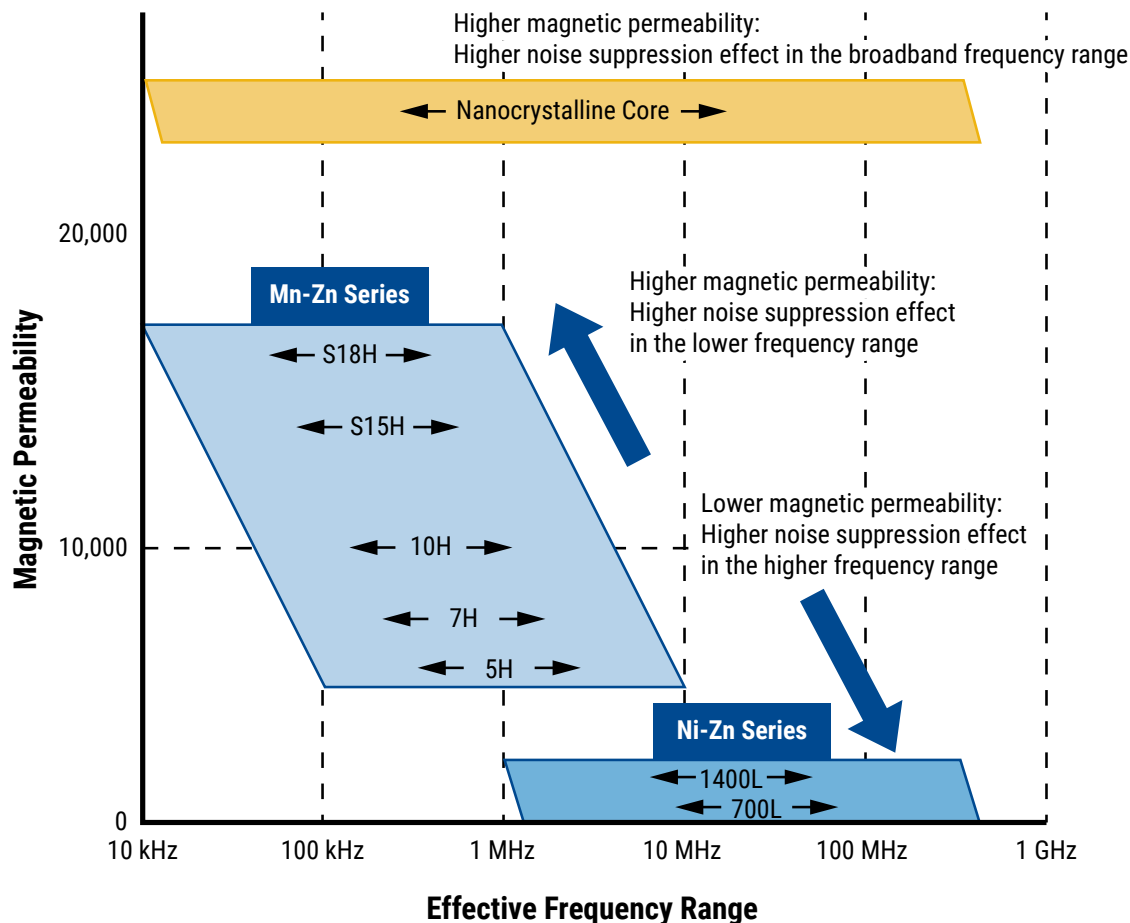

## Environmental Compliance

All KEMET EMI cores are RoHS compliant.



## Dimensions – Millimeters

**Standard Case Type**

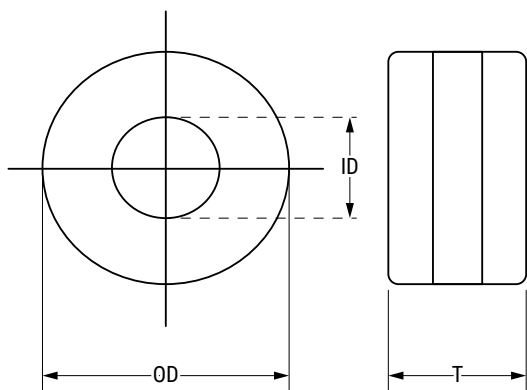

**With Fixing Base Type**

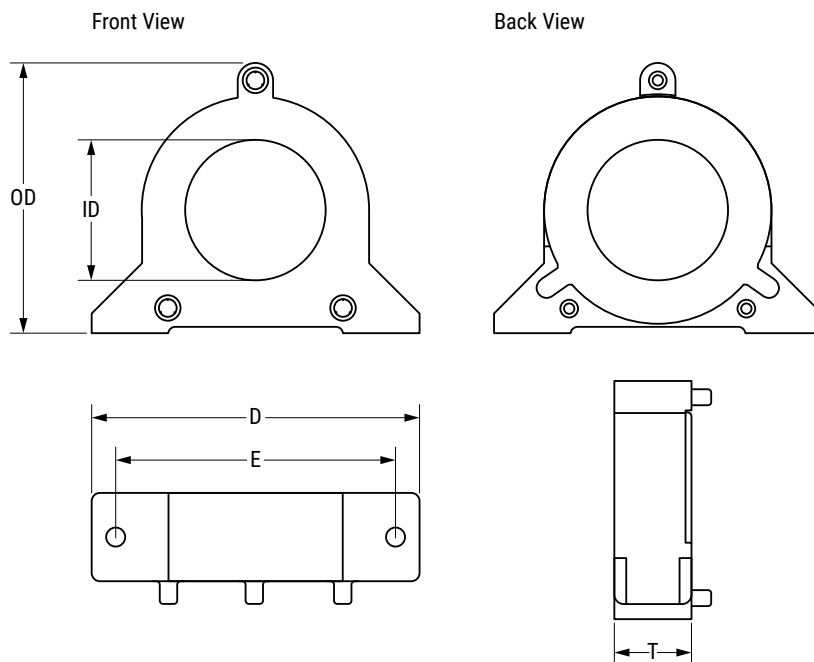

See Table 1 for dimensions

## Installation Example

### Standard Case Type

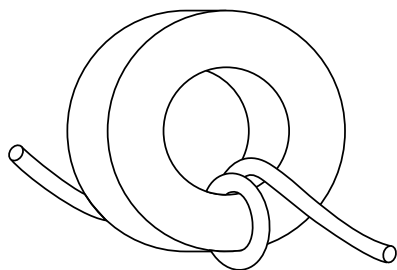

### With Fixing Base Type

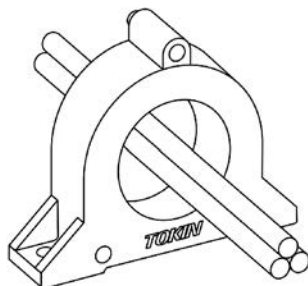

2x M5 screws for ESD-R-783926H-NC21-BT

2x M6 screws for ESD-R-1317426H-NC21-BT

Front

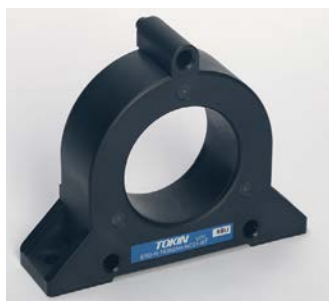

Back



Connecting



## Performance Characteristics

| Item                        | Performance Characteristics        |
|-----------------------------|------------------------------------|
| Operating temperature       | Standard case : -40°C to +120°C    |
|                             | With fixing base : -40°C to +130°C |
| Frequency range             | Broadband (low and high) frequency |
| Outer diameter              | 29.0 – 146.0 mm                    |
| Inner diameter              | 12.7 – 96.0 mm                     |
| Thickness                   | 16.0 – 37.0 mm                     |
| Type                        | Case, and with fixing base         |
| Case flame resistant rating | UL94 V-0                           |
| Material                    | Nanocrystal                        |

**Table 1 – Ratings & Part Number Reference**

| Part Number            | Dimensions (mm) |           |              |              |            | Weight<br>(g) | Case Color             | Frequency Range <sup>1</sup>   |                                 | Material    |
|------------------------|-----------------|-----------|--------------|--------------|------------|---------------|------------------------|--------------------------------|---------------------------------|-------------|
|                        | OD<br>Maximum   | ID        | T<br>Maximum | D<br>Maximum | E          |               |                        | ≤ 10 MHz<br>(AM band<br>range) | ≤ 300 MHz<br>(FM band<br>range) |             |
| ESD-R-291216H-NC23     | 29.0            | 12.7 ±1.0 | 16.0         | -            | -          | 20            | Black with yellow tape | X                              | X                               | Nanocrystal |
| ESD-R-341616H-NC23     | 34.0            | 16.5 ±1.0 | 16.0         | -            | -          | 30            | Black with yellow tape | X                              | X                               | Nanocrystal |
| ESD-R-421617H-NC23     | 42.0            | 16.7 ±1.0 | 17.0         | -            | -          | 57            | Black with yellow tape | X                              | X                               | Nanocrystal |
| ESD-R-512936H-NC23     | 51.0            | 29.5 ±1.0 | 36.0         | -            | -          | 145           | Black with yellow tape | X                              | X                               | Nanocrystal |
| ESD-R-512419H-NC23     | 51.0            | 24.4 ±1.0 | 19.0         | -            | -          | 68            | Black with yellow tape | X                              | X                               | Nanocrystal |
| ESD-R-613325H-NC23     | 61.0            | 33.2 ±1.0 | 25.0         | -            | -          | 186           | Black with yellow tape | X                              | X                               | Nanocrystal |
| ESD-R-854626H-NC23     | 85.0            | 46.0 ±1.0 | 26.0         | -            | -          | 345           | Black with yellow tape | X                              | X                               | Nanocrystal |
| ESD-R-1105826H-NC23    | 110.0           | 58.5 ±1.0 | 26.0         | -            | -          | 615           | Black with yellow tape | X                              | X                               | Nanocrystal |
| ESD-R-1469637H-NC23    | 146.0           | 96.0 ±1.0 | 37.0         | -            | -          | 1200          | Black with yellow tape | X                              | X                               | Nanocrystal |
| ESD-R-783926H-NC21-BT  | 78.0            | 39.5 Min. | 26.0         | 95.0         | 80.0 ±0.5  | 186           | Black                  | X                              | X                               | Nanocrystal |
| ESD-R-1317426H-NC21-BT | 131.0           | 74.0 Min. | 26.0         | 181.0        | 150.0 ±0.5 | 560           | Black                  | X                              | X                               | Nanocrystal |

<sup>1</sup> Frequency range is for reference only. Please test with actual device before use.

## Impedance vs. Frequency

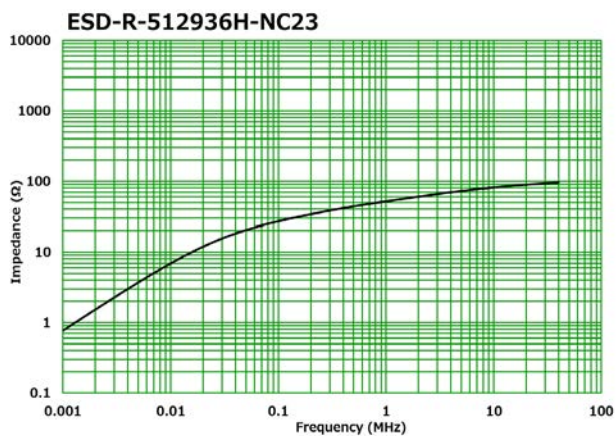
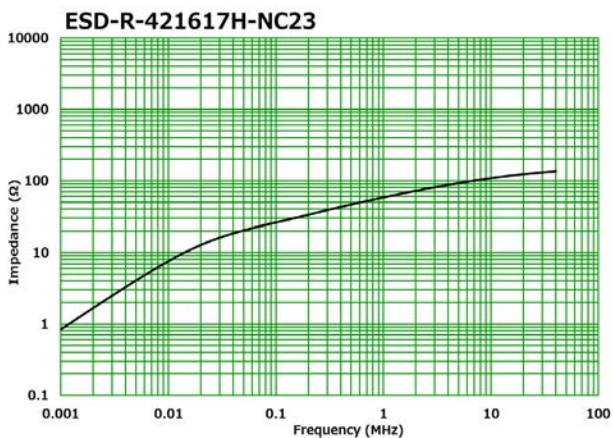
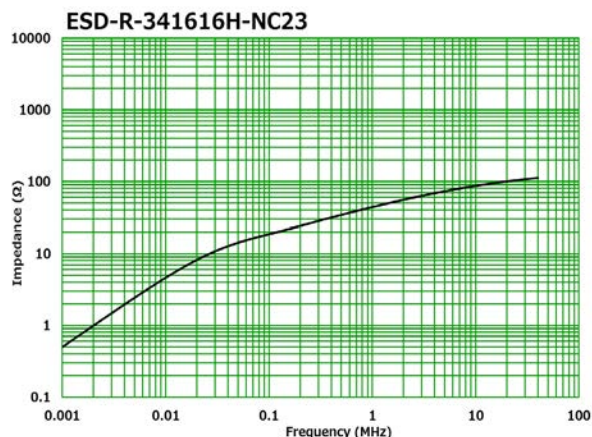
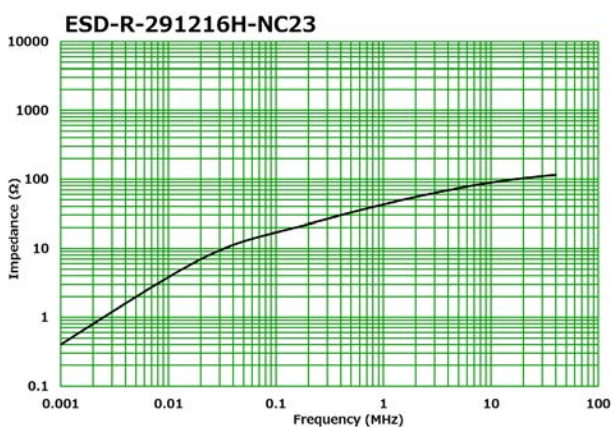



## Impedance vs. Frequency cont.

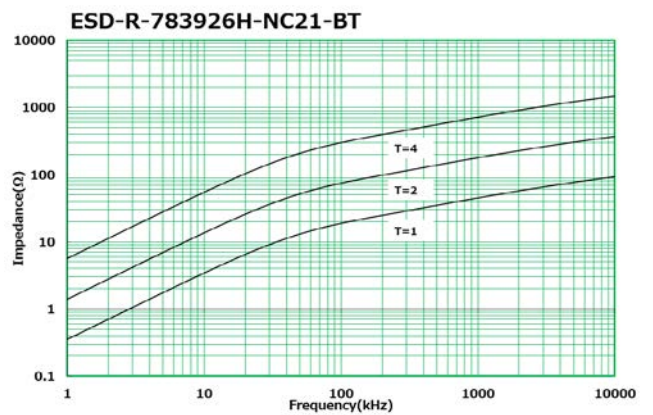
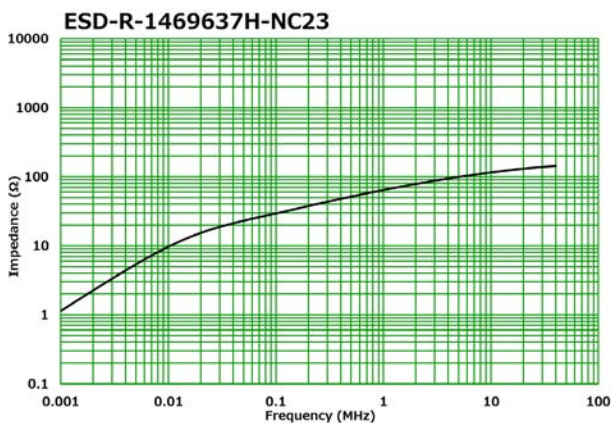
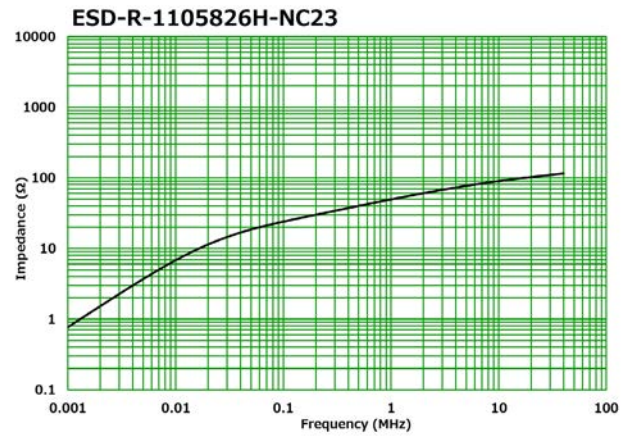
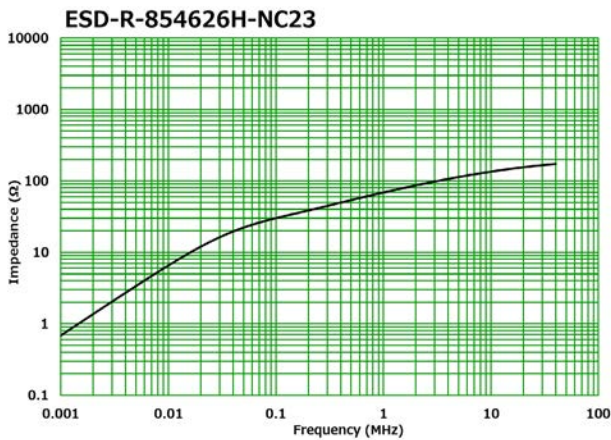
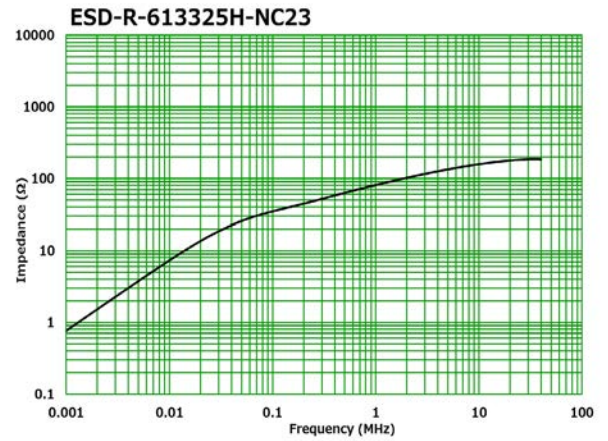
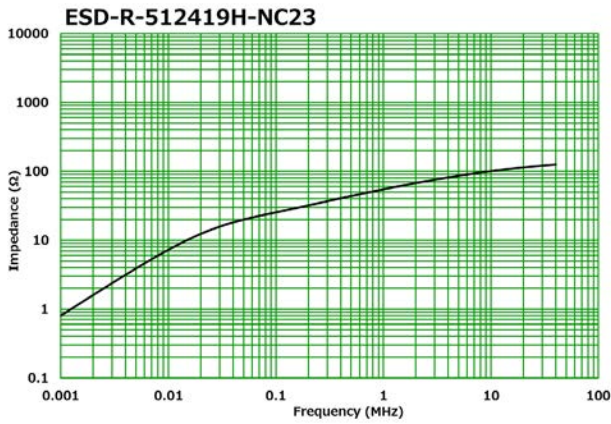

## Impedance vs. Frequency cont.

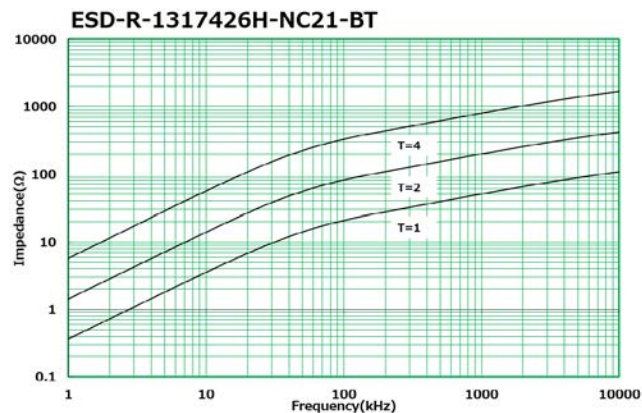

## Packaging

| Part Number            | Packaging Type | Pieces per Box |    |
|------------------------|----------------|----------------|----|
| ESD-R-291216H-NC23     | Tray           | 300            |    |
| ESD-R-341616H-NC23     |                |                |    |
| ESD-R-421617H-NC23     |                |                |    |
| ESD-R-512936H-NC23     |                |                |    |
| ESD-R-512419H-NC23     |                |                |    |
| ESD-R-613325H-NC23     |                |                |    |
| ESD-R-854626H-NC23     |                |                |    |
| ESD-R-1105826H-NC23    |                |                |    |
| ESD-R-1469637H-NC23    |                |                |    |
| ESD-R-783926H-NC21-BT  |                |                | 30 |
| ESD-R-1317426H-NC21-BT |                |                | 9  |



## Handling Precautions

EMI Cores should be stored in normal working environments. While the EMI Cores themselves are quite robust in other environments, avoid exposure to high temperatures, high humidity, corrosive atmospheres and long term storage for case, snap-on and split types.

KEMET recommends that maximum storage temperature not exceed 40°C and maximum storage humidity not exceed 75% relative humidity. Atmospheres should be free of chlorine, sulfur and alkali bearing compounds. Avoid also storage near strong magnetic fields as this might magnetize the product.

Temperature fluctuations should be minimized to avoid condensation or cracks on the parts. Mechanical shocks can bring to cracks as well.

---

## Export Control

### For customers in Japan

For products that are controlled items subject to the “Foreign Exchange and Foreign Trade Law” of Japan, the export license specified by the law is required for export.

### For customers outside Japan

EMI Core products should not be used or sold for use in the development, production, stockpiling or utilization of any conventional weapons or mass-destructive weapons (nuclear weapons, chemical or biological weapons, or missiles), or any other weapons.