

# ESD-R-H Toroidal Cores for Round Cables for Low & High Frequency & High Heat Resistance (with case)

## Overview

The KEMET ESD-R-H Series solid toroidal cores feature high heat resistance for round cables. KEMET's unique core material enables high performance in low frequency range with the Manganese Zinc (MnZn) solution and in high frequency range with the Nickel Zinc (NiZn) option. A common value is also specifically designed with a cable holding mechanism for round cable in higher heat environment.

EMI cores are part of a family of passive components which address the issues of noise or electromagnetic interference (EMI) in circuits or systems.

## Applications

- Automotive inverters
- Automotive chargers
- Automotive DC/DC converters
- Consumer electronics
- Air conditioners
- Power conditioners
- Refrigerators
- Washing machines
- Industrial equipment
- General purpose inverters
- Robots
- Information and communication devices
- Medical equipment
- Audio-visual equipment

## Benefits

- Proprietary core material for high performance in low and high frequency range
- Solid construction
- Wider operating temperature range from -40°C to +120°C
- UL94 V-0 flame retardant rated case
- Cable holding mechanism for fixing cables with bands and installation with two M4 screws



## Part Number System

ESD-	R-	12	M-H
Series	Shape Type	Core Size Outer Dimension Code (mm)	Core Material
ESD-	Ring	See Table 1	H / M-H = Mn-Zn N-H = Ni-Zn

## Turns and Impedance Characteristics

When the desired performance of an EMI core cannot be obtained with a single pass through the core, the impedance characteristics can be changed with multiple turns.

A turn is counted by the number of lead-wire windings which pass through the inner hole of the core. Windings on the outside of the core do not count.

See Figure 1 for examples of one, two, and three turns.

Adding turns will result in higher impedance while also lowering the effective frequency range.

See Figure 2 for an example.

## Core Material and Effective Frequency Range

There are two ferrite material options for KEMET EMI Cores: Nickel Zinc (Ni-Zn) and Manganese Zinc (Mn-Zn). Each core material has a different resistance and effective frequency range. The MnZn core material has a lower resistance compared to the Ni-Zn; therefore, adequate insulation is required before use.

The Ni-Zn core material is typically effective for frequencies in the MHz band range such as the FM-band, while the Mn-Zn core material is typically effective for the kHz band range such as the AM-band. See Figure 3.

It is recommended to measure the actual frequency range effectiveness in the target application.

Figure 1 – How to count turns

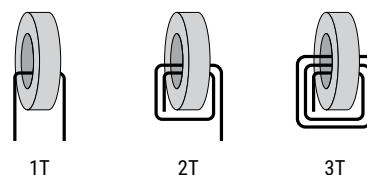

Figure 2 – Relationship between impedance and turn count. (Representative example: ESD-R-16C)

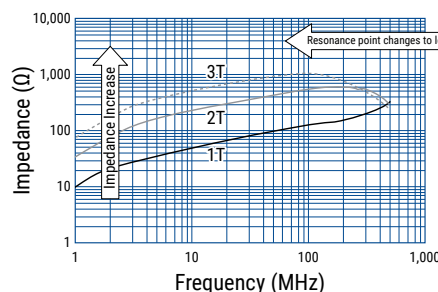
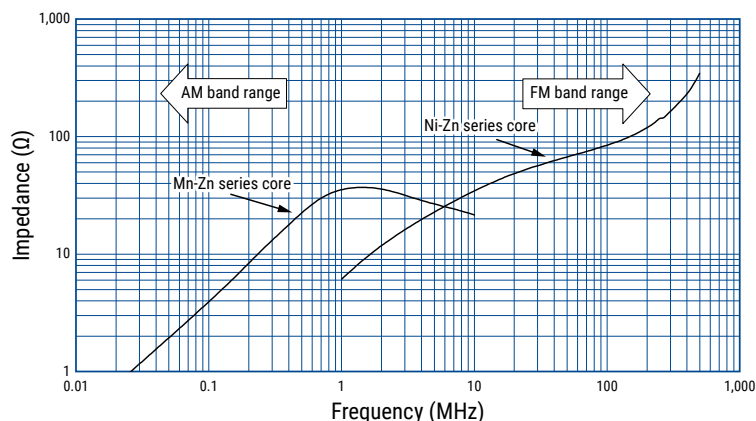

Figure 3 – Effective band range of Mn-Zn and Ni-Zn ferrite core material. (Representative example, measured with same-dimension ring core)



## Magnetic Permeability of Ferrite Material

In order to achieve most efficient noise reduction, it is important to select the material according to the target frequency band. Depending on its magnetic permeability, a particular ferrite material will be effective in a certain frequency band. A schematic representation of the relationship between the magnetic permeability of each material and the corresponding effective band range is shown in Figure 1. Materials with higher magnetic permeability are effective in the lower frequency range, while those with lower magnetic permeability are effective in the higher frequency range. Thus, Mn-Zn products are mainly used for reducing conduction noise, while Ni-Zn products are commonly used for radiation noise countermeasures.

The effective frequency range varies depending on core shape, size and number of windings. This frequency dependence of the magnetic permeability as shown in the figure serves for reference purposes only and it should be tested on the actual device to determine its effectiveness.

S18H, S15H, 10H, 7H, 5H, 1400L and 700L are KEMET's proprietary ferrite material names. Other materials can also be available on request.

Figure 4 - Relationship between the magnetic permeability of each material and its effective frequency range

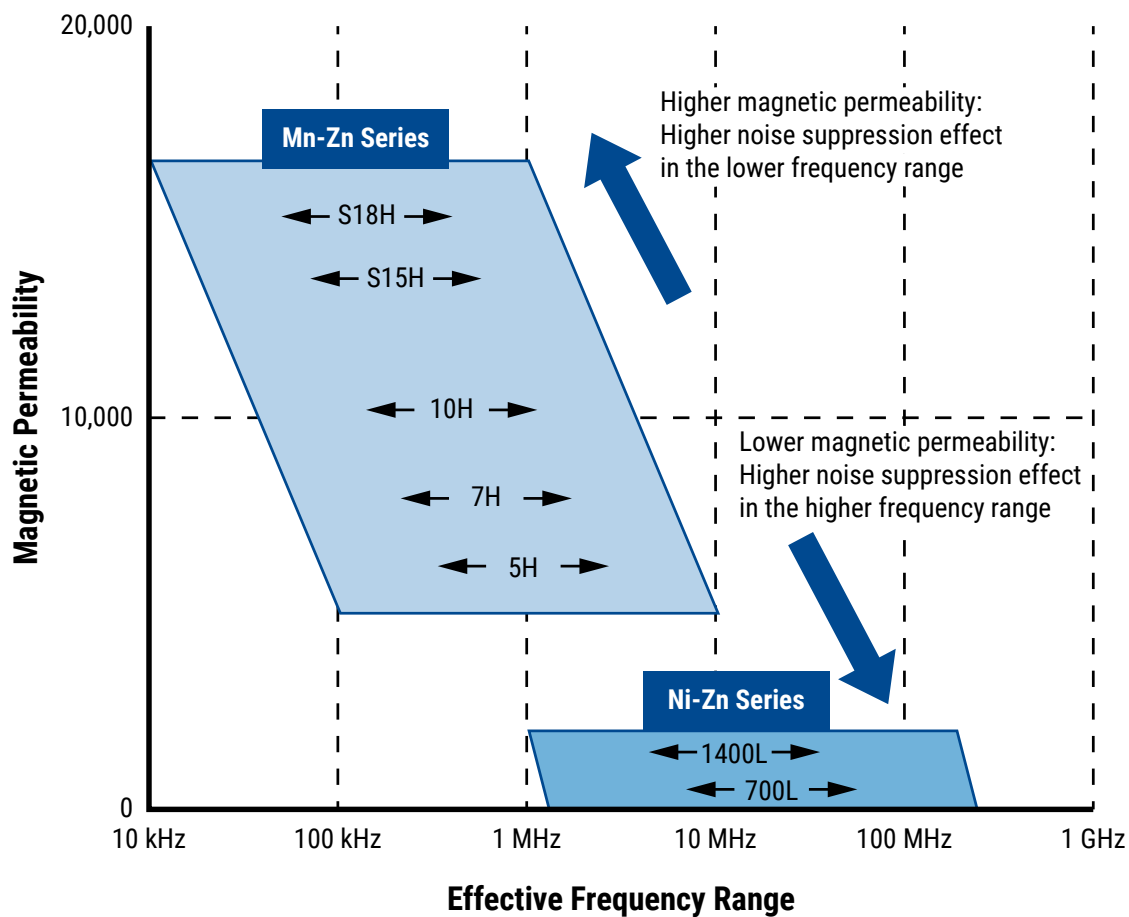

## Environmental Compliance

All KEMET EMI cores are RoHS compliant.



## Dimensions – Millimeters

Case Type

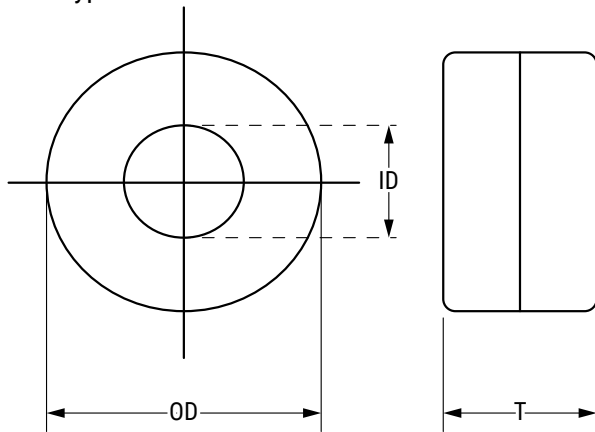

See Table 1 for dimensions

Cable Holding Mechanism Case Type (ESD-R-47H)

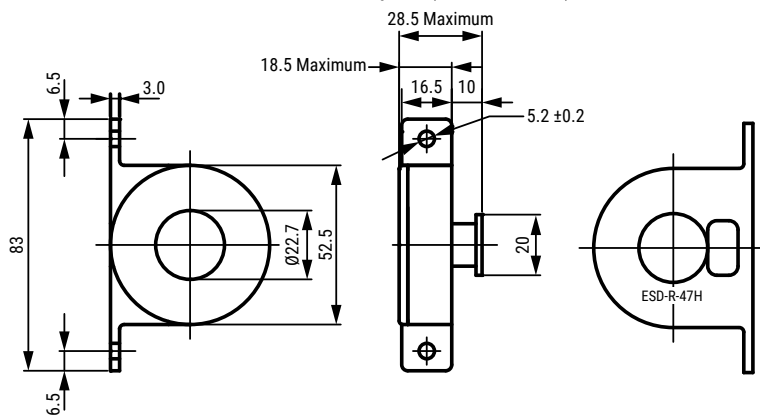

## Installation Example

Case Type

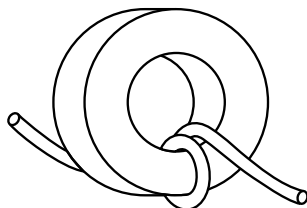

Cable Holding Mechanism  
Case Type (ESD-R-47H)

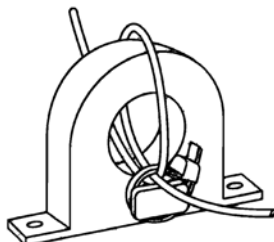

## Performance Characteristics

Item	Performance Characteristics
Operating temperature	-40°C to +120°C
Frequency range	Low frequency and high frequency
Outer diameter	15.0 – 61.0 mm
Inner diameter	5.0 – 33.2 mm
Thickness	9.0 – 25.0 mm
Type	Case
Case flame resistant rating	UL94 V-0
Material	MnZn 5H, MnZn 10H and NiZn 700L

### Table 1 – Ratings & Part Number Reference

Part Number	Dimensions (mm)			Weight (g)	Case Color	Compatible Toroid Core (Bare Type)	Frequency Range <sup>1</sup>		Material	
	OD	ID	T Maximum				≤ 10 MHz (AM band range)	≤ 300 MHz (FM band range)	MnZn	NiZn
ESD-R-12M-H	15.0 Maximum	5.0 ±1.0	9.0	2.6	White	–	X		5H	–
ESD-R-12N-H	15.0 Maximum	5.0 ±1.0	9.0	2.6	Black	ESD-R-12S		X	–	700L
ESD-R-19M-H	22.0 Maximum	7.7 ±1.0	14.0	11.8	White	ESD-R-19S	X		5H	–
ESD-R-19N-H	22.0 Maximum	7.7 ±1.0	14.0	11.8	Black	ESD-R-19SD		X	–	700L
ESD-R-25M-H	29.0 Maximum	12.7 ±1.0	16.0	21.8	White	ESD-R-25S	X		5H	–
ESD-R-25N-H	29.0 Maximum	12.7 ±1.0	16.0	21.8	Black	ESD-R-25SD		X	–	700L
ESD-R-38M-H	42.0 Maximum	16.7 ±1.0	17.0	56.0	White	ESD-R-38D	X		5H	–
ESD-R-38N-H	42.0 Maximum	16.7 ±1.0	17.0	56.0	Black	–		X	–	700L
ESD-R-47M-H	51.0 Maximum	24.4 ±1.0	19.0	91.5	White	ESD-R-47S	X		5H	–
ESD-R-47N-H	51.0 Maximum	24.4 ±1.0	19.0	91.5	Black	–		X	–	700L
ESD-R-57M-H	61.0 Maximum	33.2 ±1.0	25.0	152.0	White	ESD-R-57S	X		5H	–
ESD-R-57N-H	61.0 Maximum	33.2 ±1.0	25.0	152.0	Black	–		X	–	700L
ESD-R-47H	52.5 ±0.7	22.7 ±0.7	18.5	107.0	White	–	X		10H	–
Part Number	OD	ID	T	(g)	Color	Compatible Toroid Core (Bare Type)	≤ 10 MHz (AM band range)	≤ 300 MHz (FM band range)	MnZn	NiZn
	Dimensions						Weight	Frequency Range <sup>1</sup>		

<sup>1</sup> Frequency range is for reference only. Please test with actual device before use.

## Impedance vs. Frequency

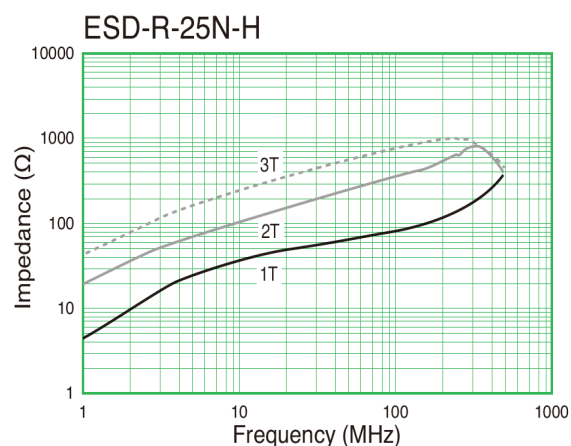
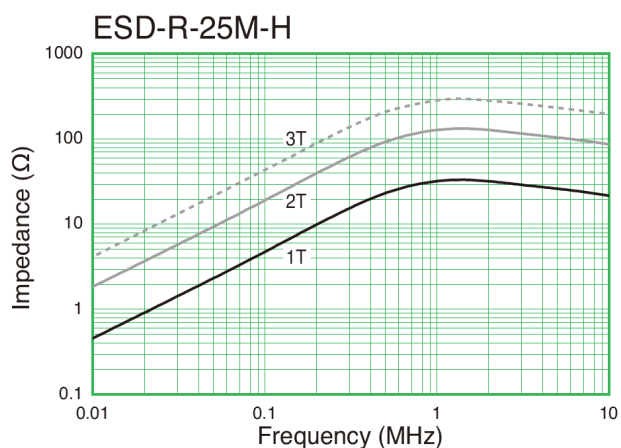
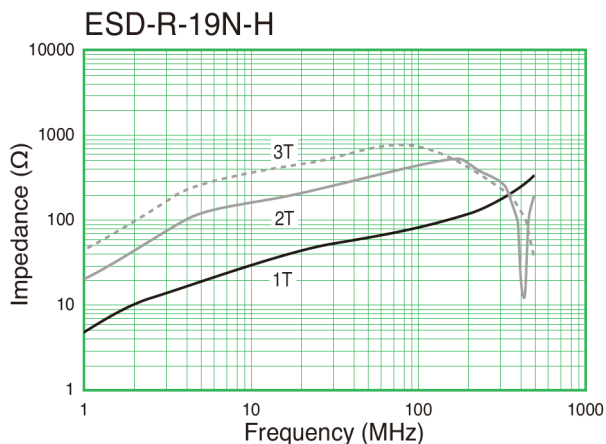
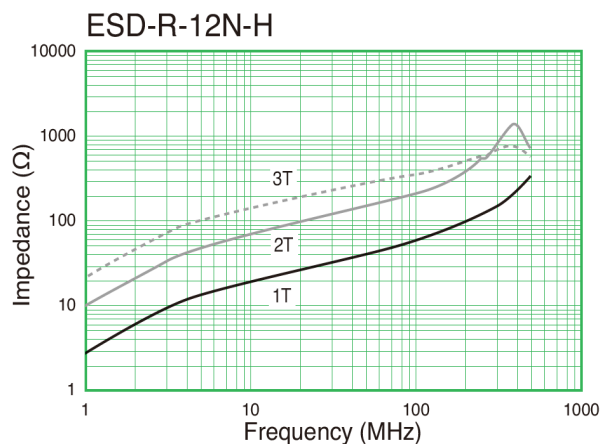
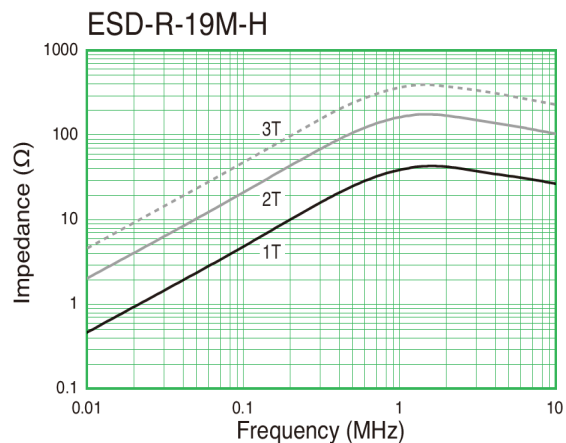
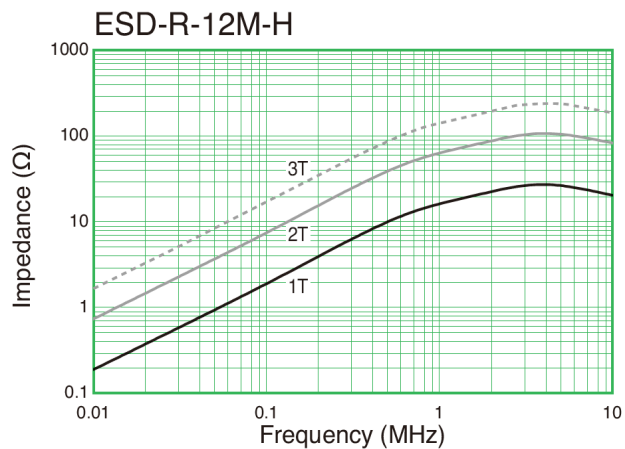

## Impedance vs. Frequency cont.

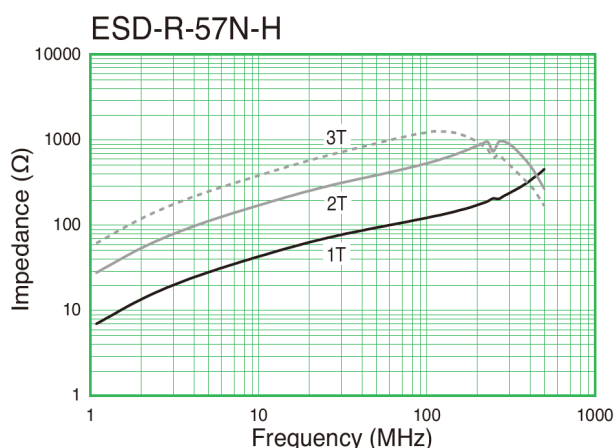
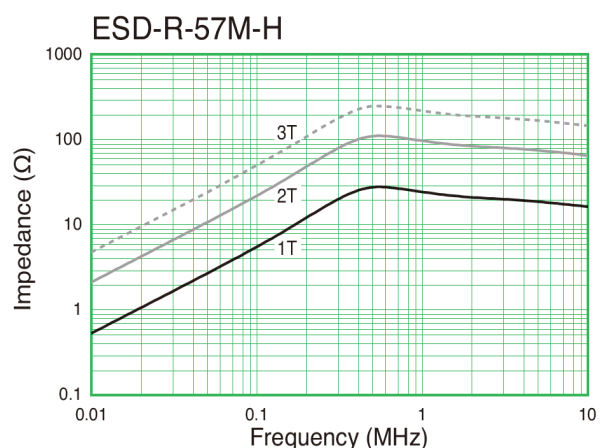
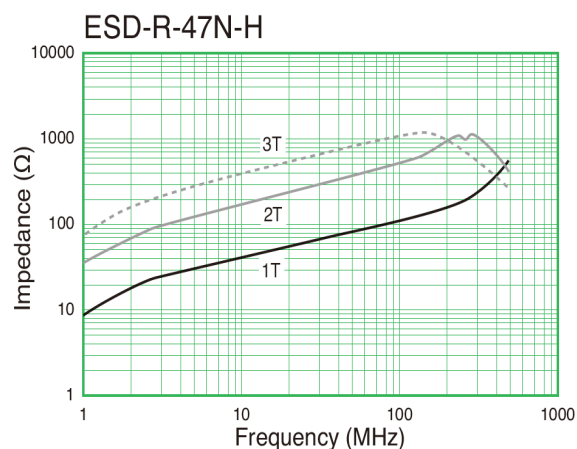
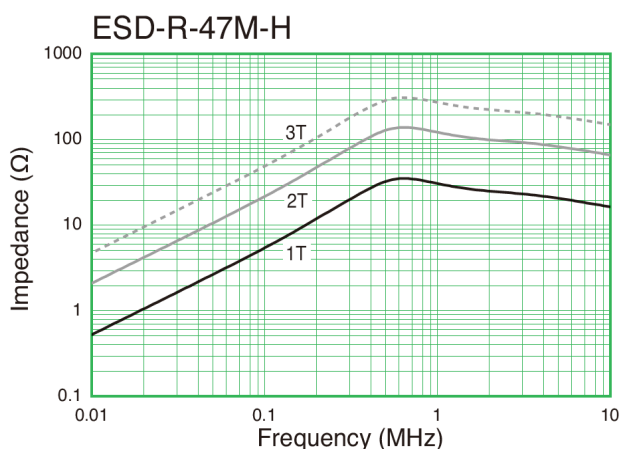
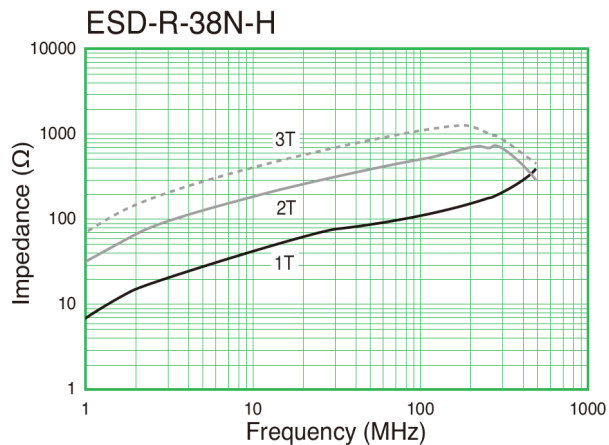
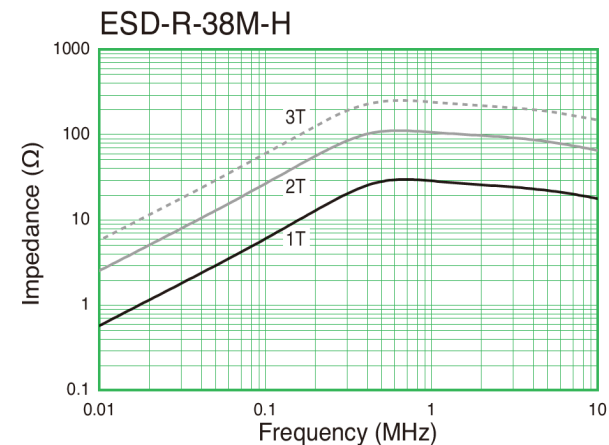

## Impedance vs. Frequency cont.

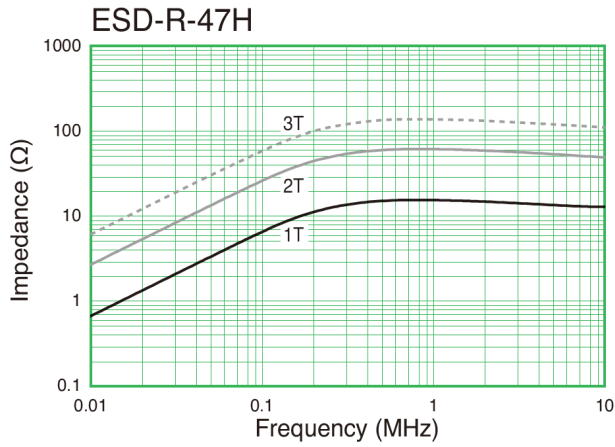

## Packaging

Part Number	Packaging Type	Pieces per Box
ESD-R-12M-H	Tray	2,000
ESD-R-12N-H		
ESD-R-19M-H		480
ESD-R-19N-H		
ESD-R-25M-H		300
ESD-R-25N-H		
ESD-R-38M-H		200
ESD-R-38N-H		
ESD-R-47M-H		100
ESD-R-47N-H		
ESD-R-57M-H		60
ESD-R-57N-H		
ESD-R-47H		



## Handling Precautions

EMI Cores should be stored in normal working environments. While the EMI Cores themselves are quite robust in other environments, avoid exposure to high temperatures, high humidity, corrosive atmospheres and long term storage for case, snap-on and split types.

KEMET recommends that maximum storage temperature not exceed 40°C and maximum storage humidity not exceed 75% relative humidity. Atmospheres should be free of chlorine, sulfur and alkali bearing compounds. Avoid also storage near strong magnetic fields as this might magnetize the product.

Temperature fluctuations should be minimized to avoid condensation or cracks on the parts. Mechanical shocks can bring to cracks as well.

---

## Export Control

### For customers in Japan

For products that are controlled items subject to the “Foreign Exchange and Foreign Trade Law” of Japan, the export license specified by the law is required for export.

### For customers outside Japan

EMI Core products should not be used or sold for use in the development, production, stockpiling or utilization of any conventional weapons or mass-destructive weapons (nuclear weapons, chemical or biological weapons, or missiles), or any other weapons.