

Electromagnetic safety interlock with separated actuator



Benefits

- **Enhancing safety.** Ideal for applications that require access to remain closed and locked until potential hazards have stopped or come to a predetermined safe state.
- **Easy to install and cost effective.** Protecting machines from interruptions in production.
- **Standards compliance.** SIL 3 in accordance with EN 62061, PL e in accordance with EN ISO 13849-1, interlock type 2 in accordance with EN ISO 14119.
- **High performance.** Reinforced polymeric casing with a protection degree IP65, operation range from -25°C to +55°C, retention force 1200N.
- **Approvals** by IMQ, CE, cULus.

Description

The Carlo Gavazzi safety switches are devices designed and manufactured in accordance with IEC international standards and EN European regulations.

This device is used on machines where the hazardous conditions remain for a while after the stop signal generation and is helpful for the realization of safety systems in accordance with ISO 14119, performing a personal protection function.

Applications

This device is useful for guarantee the safety of the operator in case of machines where the hazardous conditions remains for a while time after the generation of the stop signal, because of the mechanical inertia of moving parts, components under pressure or with high temperatures.

Main functions

- Ensure protection in inertia's machineries
- Prevents the entry in a dangerous area until the unlock signal
- With manual unlock device for emergency
- Block controlled by solenoid
- Signals generated by solenoid or actuator
- Without electronic PCB

References

▶ Order code

ESI 1 024

Enter the code option instead of

Code	Option	Description
E	-	Electromagnetic
S	-	Safety
I	-	Interlock
<input type="checkbox"/>	31	3NC (1NC actuator, 2NC solenoid) + 1NO (solenoid)
<input type="checkbox"/>	22	2NC (solenoid) + 2NO (1NO actuator, 1NO solenoid)
<input type="checkbox"/>	13	1NO (actuator) + 3NC (1NC actuator, 2NC solenoid)
1	-	Head orientation: frontal
<input type="checkbox"/>	E	Electrical block
<input type="checkbox"/>	M	Mechanical block
024	-	24 Vac/dc

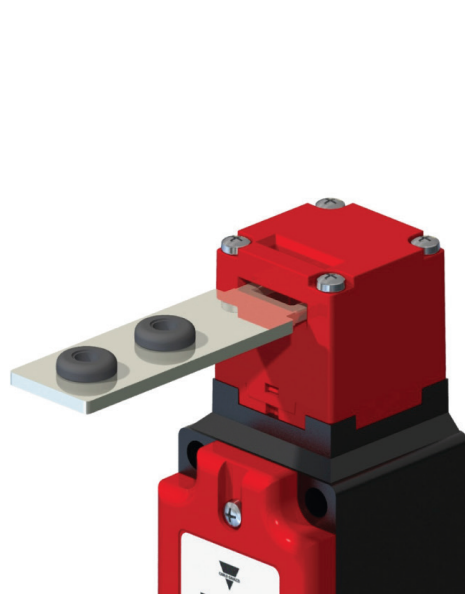

Fig. 1 Head orientation

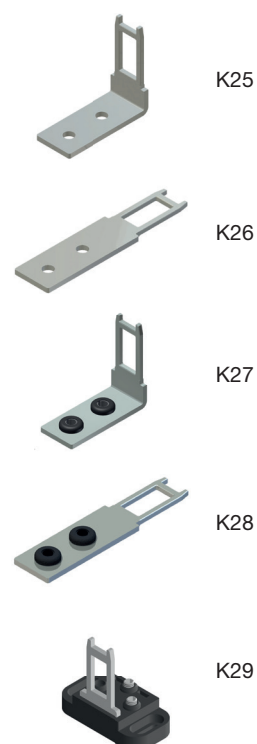

Fig. 2 Actuators (to be ordered separately)

Selection guide: electrical interlock

Part number	Electrical interlock	Coil
ESI311E024	1NO + 2NC (Coil) + 1NC (Actuator)	24Vac/dc
ESI221E024	1NO + 2NC (Coil) + 1NO(Actuator)	24Vac/dc
ESI131E024	2NC (Coil) + 1NO + 1NC (Actuator)	24Vac/dc



Selection guide: mechanical interlock

Part number	Mechanical Interlock	Coil
ESI311M024	1NO + 2NC (Coil) + 1NC (Actuator)	24Vac/dc
ESI221M024	1NO + 2NC (Coil) + 1NO(Actuator)	24Vac/dc
ESI131M024	2NC (Coil) + 1NO + 1NC (Actuator)	24Vac/dc

CARLO GAVAZZI compatible components

Purpose	Component name/code	Notes
Safety modules	CM	-
Safety module	CMM	-
Safety modules	SMS	-

Further reading

Information	Where to find it	QR
Instruction manual	http://www.productselection.net/MANUALS/UK/ESI_IM.pdf	
SISTEMA Libraries	http://www.gavazzi-automation.com/nsc/HQ/EN/safety_modules	

Structure

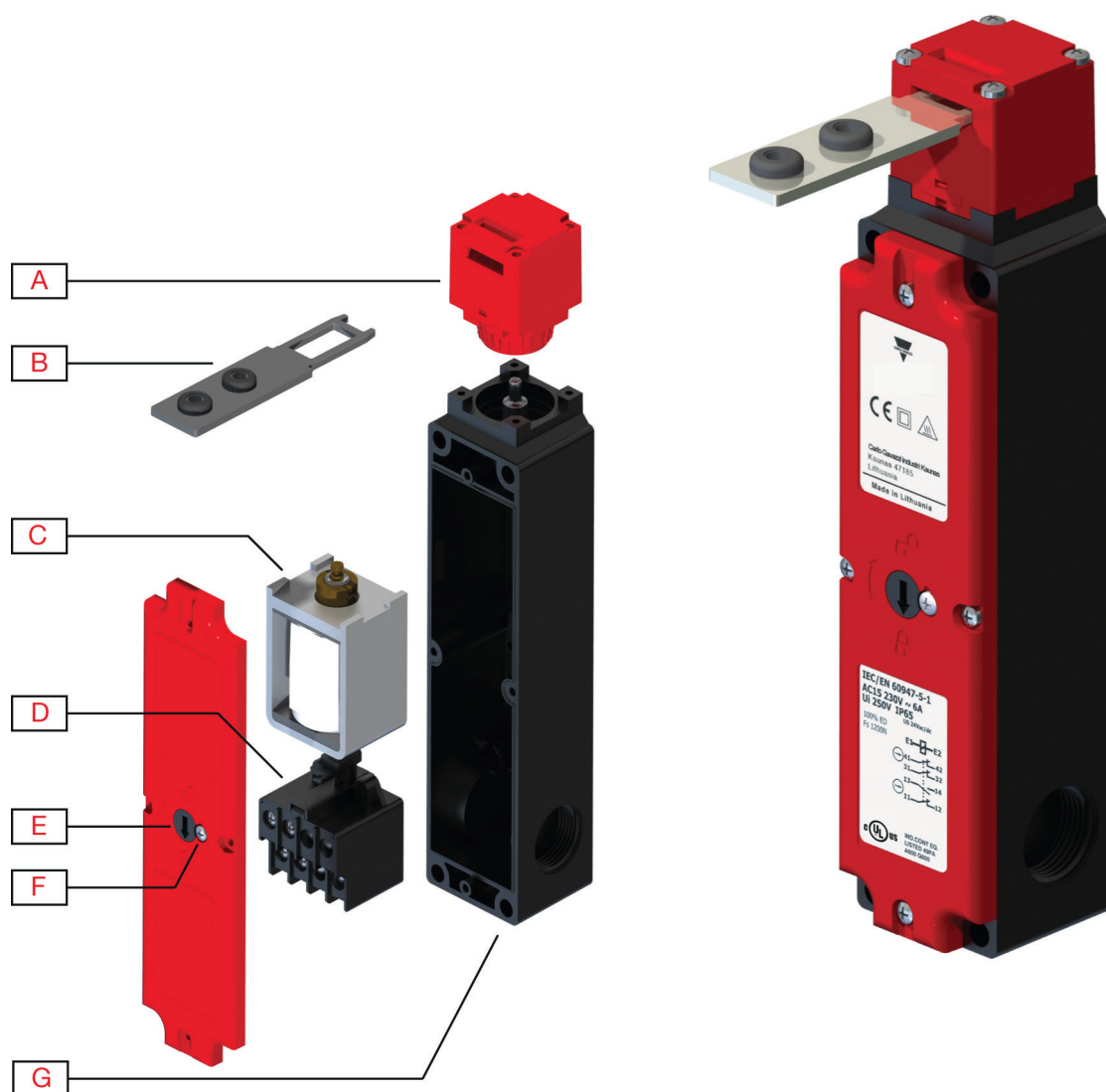

Element	Component
A	Operating head
B	Actuator*
C	Solenoid
D	Contact block
E	Manual unlock device
F	Release device with security screw
G	3x M20 cable inlet

* To be ordered separately (fig. 2)

Features

General

Casing	Polimeric
Weight	440g

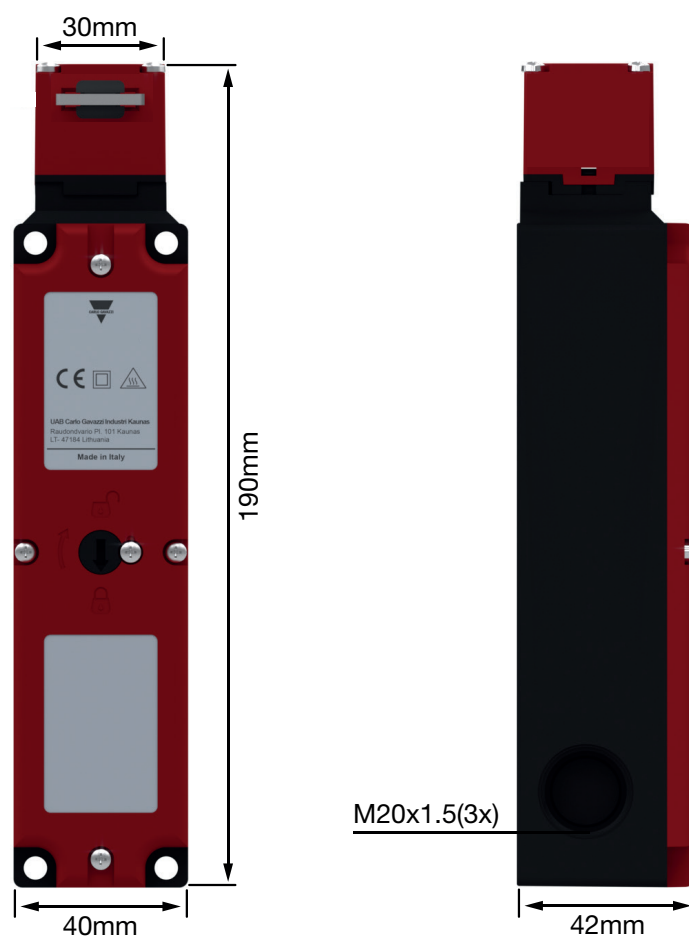

Performance

Max actuating speed	20 m/min
Switching frequency	600 cycles/h
Retention force at locked actuator	1200N
Resistance between contacts	25 mΩ
Mechanical durability	1 million of operations
B10d	4 million of operations

Contact block





Rated impulsive withstand voltage Uimp	2,5 kV
Conventional free air thermal current Ith	10A
Rated operating current AC-15	24V - 10A
Rated operating current AC-15	230V - 4A
Rated operating current DC-13	24V - 4A

Connection specifications

Connecting terminals	M3 screws with cable clamp
Wiring dimensions*	0.34 - 1.5 mm ²

* Use only copper conductors 60/70°C, AWG14-18, stranded and solid conductor. Clamps tightening torque 0.8Nm.

Compatibility and conformity

Standard compliance	Low Voltage Directive 2014/35/EU in accordance with EN/IEC 60947-5-1 Machinery Directive 2006/42/CE in accordance with EN ISO 14119 SIL 3 in accordance with EN 62061 PL e in accordance with EN ISO 13849-1 Interlock type 2 in accordance with EN ISO 14119
Terminal marking	In accordance with IEC 60947-5-1
Approvals	    

Environmental

Operating temperature	-25 ÷ 55°C
Environmental designation	Type-1 enclosure
Protection against electrical shock	Classe II
IP protection degree	IP65
Rated insulation voltage Ui	250V
Utilization category according to UL508	A300 - Q300

Electrical interlock

- Actuator locked when the solenoid is activated.
- The release is possible by switching off the power supply.

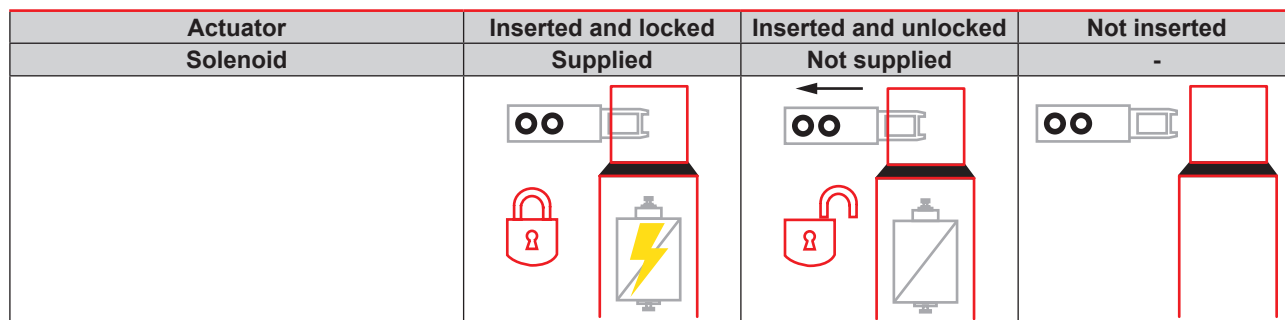

Type	Actuation			
ESI31	1NC actuator	11 12	11 12	11 12
	1NC solenoid	21 22	21 22	21 22
	1NO solenoid	33 34	33 34	33 34
	1NC solenoid	41 42	41 42	41 42
ESI22	1NO actuator	13 14	13 14	13 14
	1NC solenoid	21 22	21 22	21 22
	1NO solenoid	33 34	33 34	33 34
	1NC solenoid	41 42	41 42	41 42
ESI13	1NO actuator	13 14	13 14	13 14
	1NC solenoid	21 22	21 22	21 22
	1NC solenoid	31 32	31 32	31 32
	1NC actuator	41 42	41 42	41 42

Attention: in case of lack of voltage the device allows the immediate access to the protected area