

ESP32-LyraTD-MSD

User Guide



Version 2.7
Espressif Systems
Copyright © 2019

About This Guide

Release Notes

Date	Version	Release Notes
2018.03	V1.0	First Release.
2018.04	V2.0	<ul style="list-style-type: none">Added a major support for the Alexa Voice Service (AVS) framework;Rebuilt this user guide.
2018.04	V2.1	Added Appendix A with schematics.
2018.04	V2.2	Removed the content in Chapter 3 and added the link to the instruction of configuring for AVS on GitHub.
2018.05	V2.3	Updated the schematics in Appendix A.
2018.07	V2.4	Removed the “QIO” option for “SPI MODE” in Chapter 2.2.2.
2018.07	V2.5	<ul style="list-style-type: none">Updated Figure 1-1;Updated Chapter 2.2.2.
2018.12	V2.6	<ul style="list-style-type: none">The board comes with ESP32-WROVER-B, instead of ESP32-WROVER, now;Fixed a typo;Updated Schematics.
2019.08	V2.7	<ul style="list-style-type: none">Added description of flashing in Chapter 2;Updated description of voice recognition in Section 2.4 and 3.1.

Documentation Change Notification

Espressif provides email notifications to keep customers updated on changes to technical documentation. Please subscribe [here](#).

Certificates

Please download the product certificate(s) from [here](#).

Table of Contents

1. Overview	1
1.1. ESP32-LyraTD-MSD	1
1.2. Hardware Resources.....	2
2. Configuring for DuerOS	4
2.1. Software Preparation	4
2.2. Flashing the Firmware	5
2.2.1. Driver Installation	5
2.2.2. Flashing ESP32.....	5
2.3. Network Configuration	8
2.3.1. Wi-Fi Networking	8
2.4. Interactive Function.....	10
2.4.1. Voice Recognition	10
2.4.2. Buttons	10
3. Configuring for AVS	11
3.1. Interactive Function.....	11
3.1.1. Voice Recognition	11
3.1.2. Buttons	11
A. Appendix - Schematics	12
A.1. The upper board (A)	12
A.2. The lower board (B).....	16



1.

Overview

ESP32-LyraTD-MSC, one of Espressif's Audio Development Boards, is an Acoustic Echo Cancellation (AEC) solution supporting voice recognition, near-field and far-field voice wake-up. Audio files in the format of AAC, FLAC, OPUS and OGG can be decoded and output without quality loss. It also supports connection to Baidu's DuerOS and Amazon's AVS (Alexa Voice Service).

1.1. ESP32-LyraTD-MSC

ESP32-LyraTD-MSC is based on ESP32-WROVER-B, a BT/Wi-Fi combo module, and a digital signal processor (DSP) that features a three-microphone array for noise reduction, echo cancellation, etc. ESP32-LyraTD-MSC is integrated with peripheral devices and consists of two development boards. The upper board mainly consists of the microphone array, function keys and LED lights. The lower board is integrated with power management, Wi-Fi and audio modules.

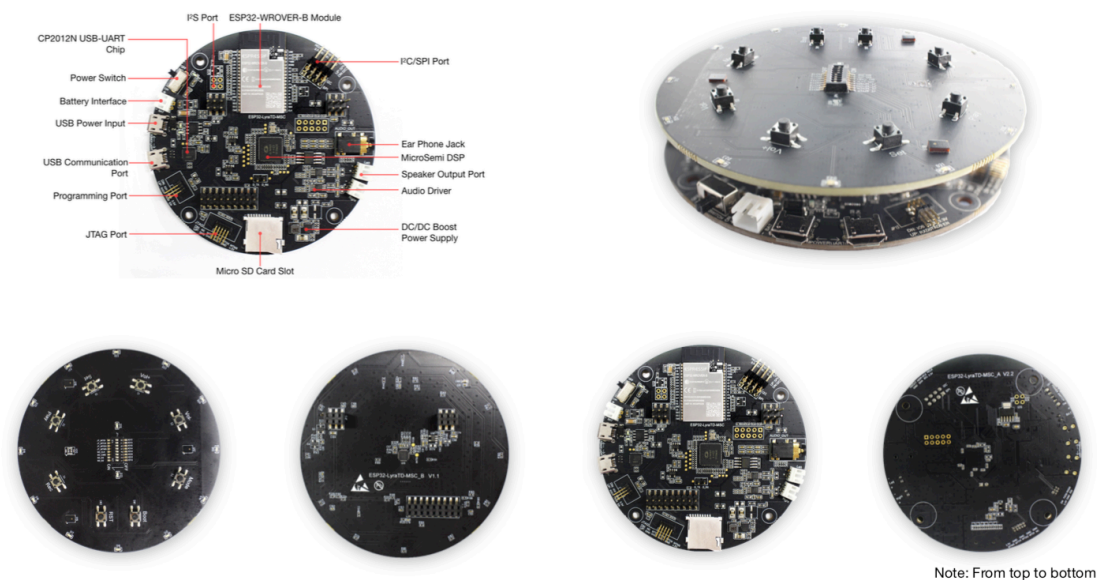

Figure 1-1. ESP32-LyraTD-MSC



1.2. Hardware Resources

1. USB power input

Provides power supply to the whole system.

It is recommended that the system be connected to a power adapter for sufficient current supply.

2. Battery interface

Provides power supply to the whole system when the USB power interface is not used.

The development board integrates the AP5056 power management IC to support battery charging.

3. Power switch

Turn on the switch and the system will be powered on.

Turn off the switch and the system will be powered off.

4. I²S port

An I²S bus transmits audio data between ESP32 and the DSP.

5. ESP32-WROVER-B module

This is a powerful, general-purpose, Wi-Fi+BT+BLE MCU module, targeting a wide variety of applications ranging from low-power sensor networks to the most demanding tasks, such as voice encoding, music streaming and MP3 decoding.

6. MicroSemi DSP

This audio co-processor is used for Automatic Speech Recognition (ASR) applications. It captures audio data from an external microphone array and outputs audio signals through its Digital-to-Analog-Converter (DAC) port.

7. I²C/SPI port

ESP32, as an I²C master, can access slave devices via the I²C bus.

ESP32, as an SPI master, can access the DSP to read/write data via the SPI bus.

8. Earphone jack

Used for plugging in earphones.

9. Dual speaker output port

Supports two external speaker outputs.

10. Audio driver

This audio power amplifier sends audio signals from the DSP to external speakers for playback.

11. DC-DC boost power supply

This fixed-frequency DC-DC voltage booster powers the audio driver.



12. Micro SD card

The development board supports a Micro SD card in SPI/1-bit/4-bit modes, and can store or play audio files in the Micro SD card.

13. JTAG port

This standard JTAG interface is compatible with the ESP32 programming board and supports debugging functions.

14. CP2102N USB-UART Chip

An upgraded version of the CP2102 chip supports USB-to-UART conversion.

⚠ Notice:

The IC design of this chip is a little different from CP2102.

15. Programming port

This programming and debugging interface of ESP32 is compatible with the ESP32 programming board.

16. USB Communication Port

This is a normal USB communication port between PC and ESP32 module.



2. Configuring for DuerOS

ESP32-LyraT comes with factory firmware by default. Users do not need to flash once more and can start directly from the network configuration, then realize voice dialogue.

In case you still need to flash, see below:

2.1. Software Preparation

1. Flash Download Tool

To flash firmware into the board, please download the [Flash Download Tool](#).

2. App for Device Networking

To use the SmartConfig functionality and configure networking for ESP32-LyraTD-MS-C, please download from [Espressif Apps](#) either of the following two: IOT Espressif for Android APK or ESP-TOUCH for iOS IPA.

3. Debugging Tool

Use a debugging tool that suits your development environment, such as Xshell or SSCOM, etc.

4. Hardware

- 1 x PC (Windows Operating System is recommended);
- 2 x Micro USB cables (one is for the USB power supply);
- 1 x Speaker.



2.2. Flashing the Firmware

2.2.1. Driver Installation

Connect the board to a PC with a Micro-USB cable and install the USB-to-UART driver.



Figure 2-1. Installing the USB-to-UART Driver

2.2.2. Flashing ESP32

2.2.2.1. ESP32 Download Tool

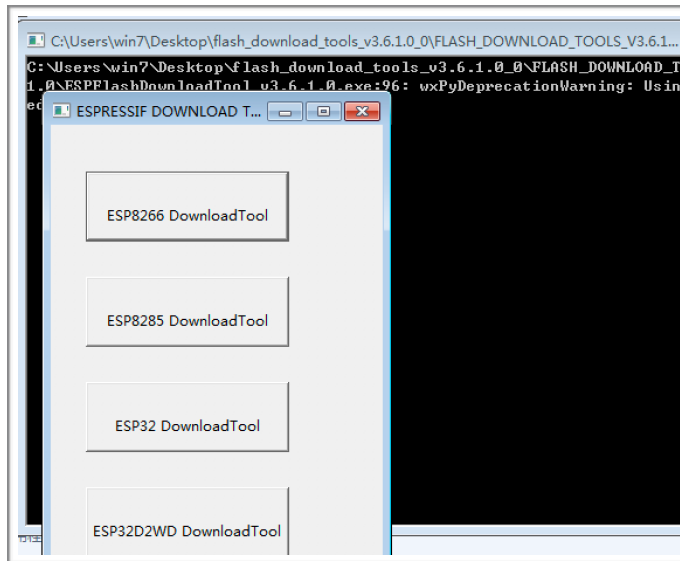

Figure 2-2. ESP32 Download Tool



2.2.2.2. Flashing Firmware into ESP32

1. Double-click on “ESP32 Download Tool” at the interface, as shown in Figure 2-2, after downloading the [Flash Download Tool](#). The following interface will be shown:

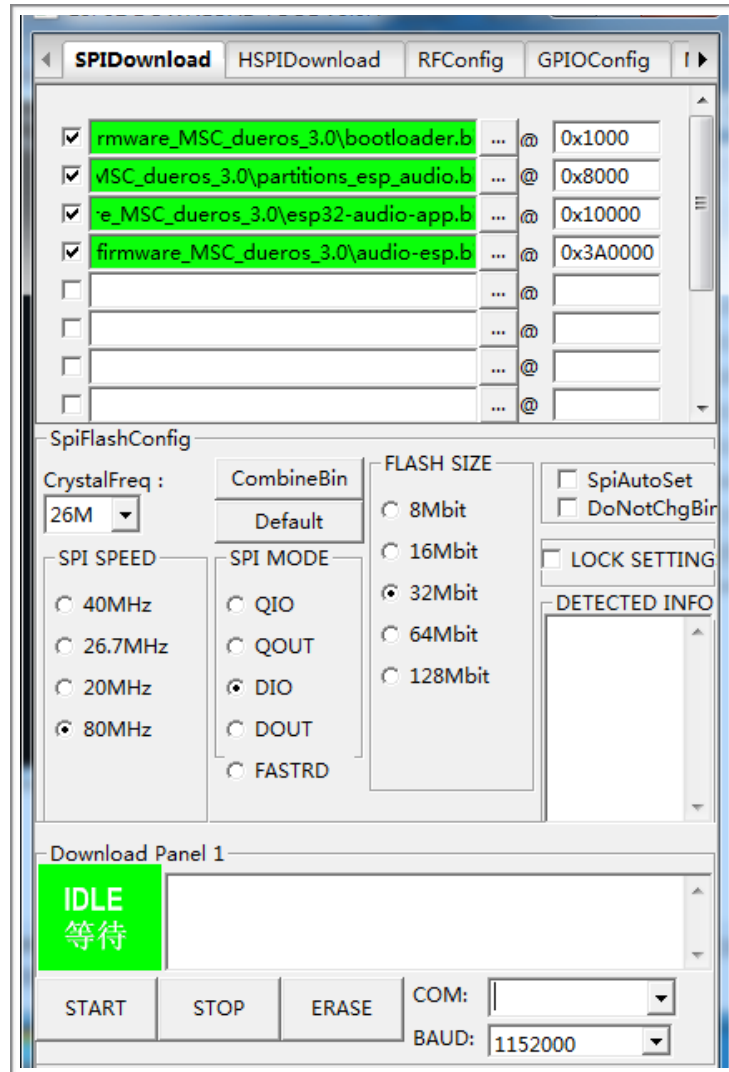

Figure 2-3. ESP32 Download Tool

2. Configuration for Flashing Firmware

- Addresses for Downloading Firmware

Binary Files	Address	Function
<i>Bootloader.bin</i>	0x1000	basic configuration
<i>partitions_esp_audio.bin</i>	0x8000	basic configuration
<i>esp32-audio-app.bin</i>	0x10000	audio application
<i>audio-esp.bin</i>	0x3A0000	audio instruction



- The SPI Download configuration on the ESP32 Download Tool is shown in Figure 2-3. Select “**80 MHz**” for “SPI SPEED”; select “**DIO**” for “SPI MODE”; and select “**32 Mbit**” for “FLASH SIZE”.
- Select the COM port in line with the one used by the PC; select “1152000” as a baud rate.

3. Power-on and Programming



Figure 2-4. Powering on the Board

- Power on ESP32-LyraTD-MS-C.
- Click the “Start” button on the ESP32 Flash Download Tool to start downloading the firmware.
- Press and hold the “Boot” button, and press the “RST” button on the board to enter the download mode.
- Wait for the download to finish.

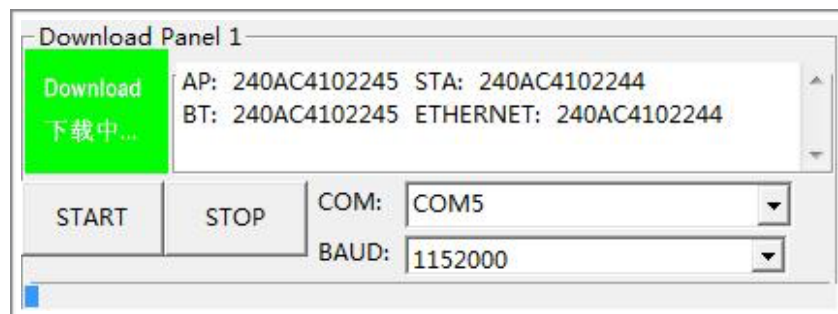

Figure 2-5. Downloading Firmware



2.3. Network Configuration

2.3.1. Wi-Fi Networking

1. After successfully downloading the firmware, power on the board again by pressing the RST button. In about 2 seconds, the blue LED light on the board will flash, indicating that ESP32 is searching for a wireless network.



Figure 2-6. The LED Light on ESP32-LyraTD-MSC

2. To configure the network for the first time (or to change the SSID of the network), press the “SET” button on the board for as long as 6 seconds.
 - Upon hearing the Chinese audio message “kai shi pei dui” (meaning: “networking starts”) or when the blue LED light starts blinking, release the “SET” key.



- Connect ESP32-LyraTD-MSC to the network, using the IoT Espressif app downloaded to your phone.

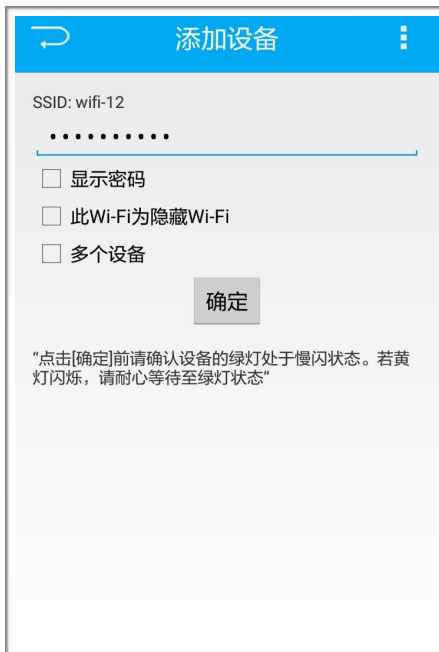

Figure 2-7.Interface of IoT Espressif for Android APK

3. After connecting ESP32-LyraTD-MSC to the network, the blue LED light will be on steadily, and an audio message in Chinese “wang luo lian jie cheng gong” (meaning “successful network connection”) will be played.
4. Reboot the board after the networking is successfully established. The board will automatically connect to the network configured during the last connection.



2.4. Interactive Function

2.4.1. Voice Recognition

When ESP32-LyraTD-MSC is connected to DuerOS, ESP32 supports “Hi Le Xin” as a wake-up phrase. Saying “Hi Le Xin” to the board prompts the following response in Chinese: “nin hao you shen me fen fu” (meaning: “Hi! How can I help?”). Users can talk to the board and instruct it to play songs and news, or they can perform other similar voice interactions. Here is an operation sample:

- Say “Hi Le Xin” to the board, and it will respond in Chinese by saying: “nin hao you shen me fen fu” (meaning: “Hi! How can I help?”).
- Then, ask the following question in Chinese: “tian qi zen me yang” (meaning “How is the weather?”).
- The board will respond in Chinese by saying: “jin tian yin zhuan duo yun” (meaning “It’s getting from overcast to just cloudy today.”).

 **Notice:**

If the board does not respond after you saying “Hi Le Xin” for many times, you can try the following buttons to wake up (early factory firmware versions may not support voice wake-up interaction).

2.4.2. Buttons

- The “Play” button can be used to play or pause the audio streaming.
- The “Vol+” and “Vol-” buttons can be used to adjust the volume of the sound. Press them repeatedly until you reach the desired sound volume.



3. Configuring for AVS

For the illustration of flashing the AVS firmware, please refer to <https://github.com/espressif/esp-avs-sdk>.

3.1. Interactive Function

3.1.1. Voice Recognition

When the device boots up and connects successfully to the Wi-Fi network, the blue LED light will blink once, indicating that it is ready to accept commands.

Then, you can wake it up with the “Hi Le Xin” keyword. When it is woken-up and listening, the LED light will glow in solid blue. When it is in a “thinking” mode, the LED light will rotate.

We presently support “Tune-In Radio” as a music service. Other music services are not supported as of yet.

You can interact with the board, using normal free speech. Some examples can be:

- “Hi Le Xin, what is the weather like?”
- “Hi Le Xin, sing a song”
- “Hi Le Xin, stop”
- “Hi Le Xin, tell me a joke”
- “Hi Le Xin, play Radio City on ‘Tune-In Radio’ ”

3.1.2. Buttons

The “Vol+” and “Vol-” buttons can be used to adjust the volume of the sound. Press repeatedly until you reach the desired sound volume.



A. Appendix - Schematics

A.1. The upper board (A)

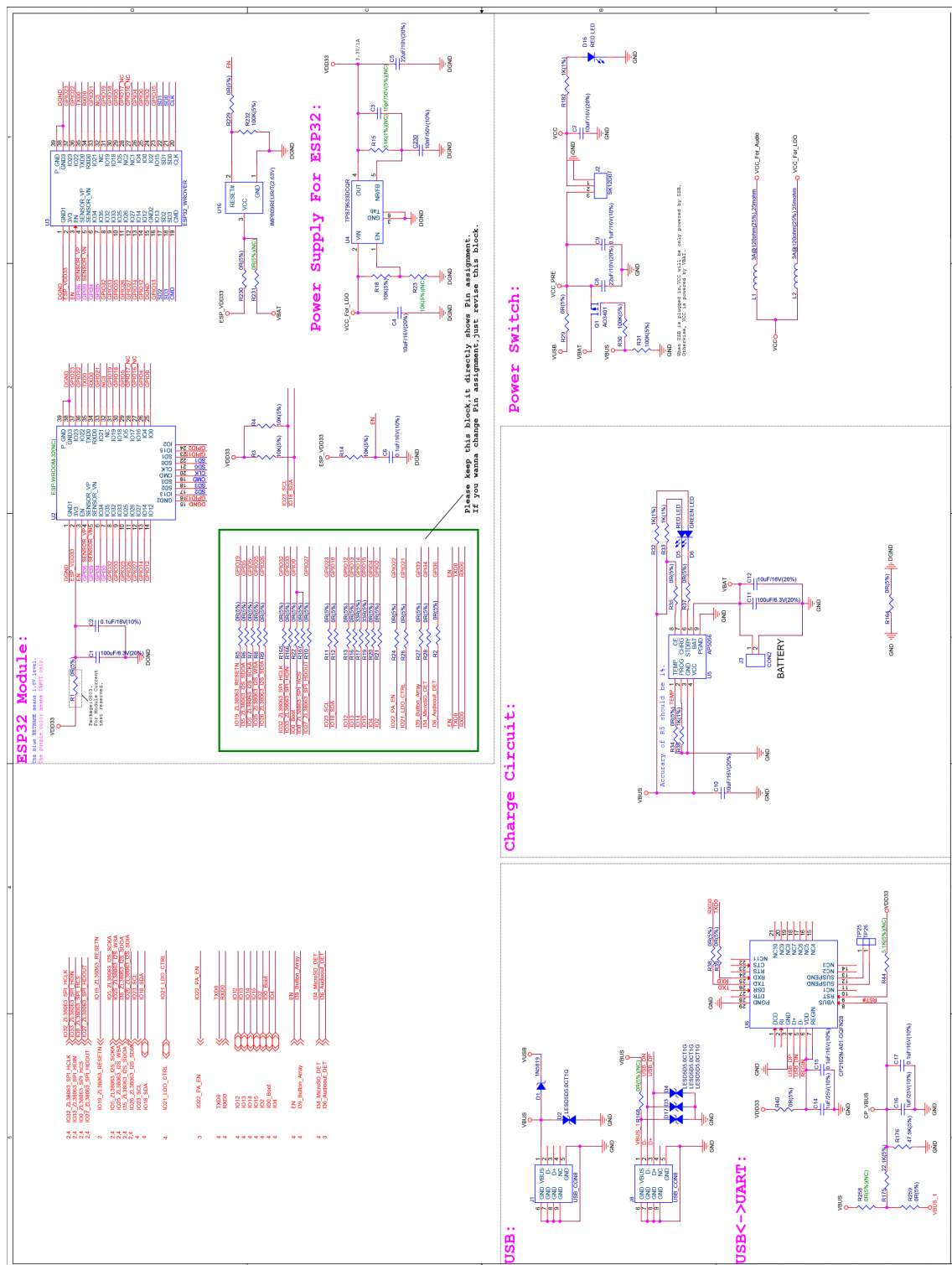

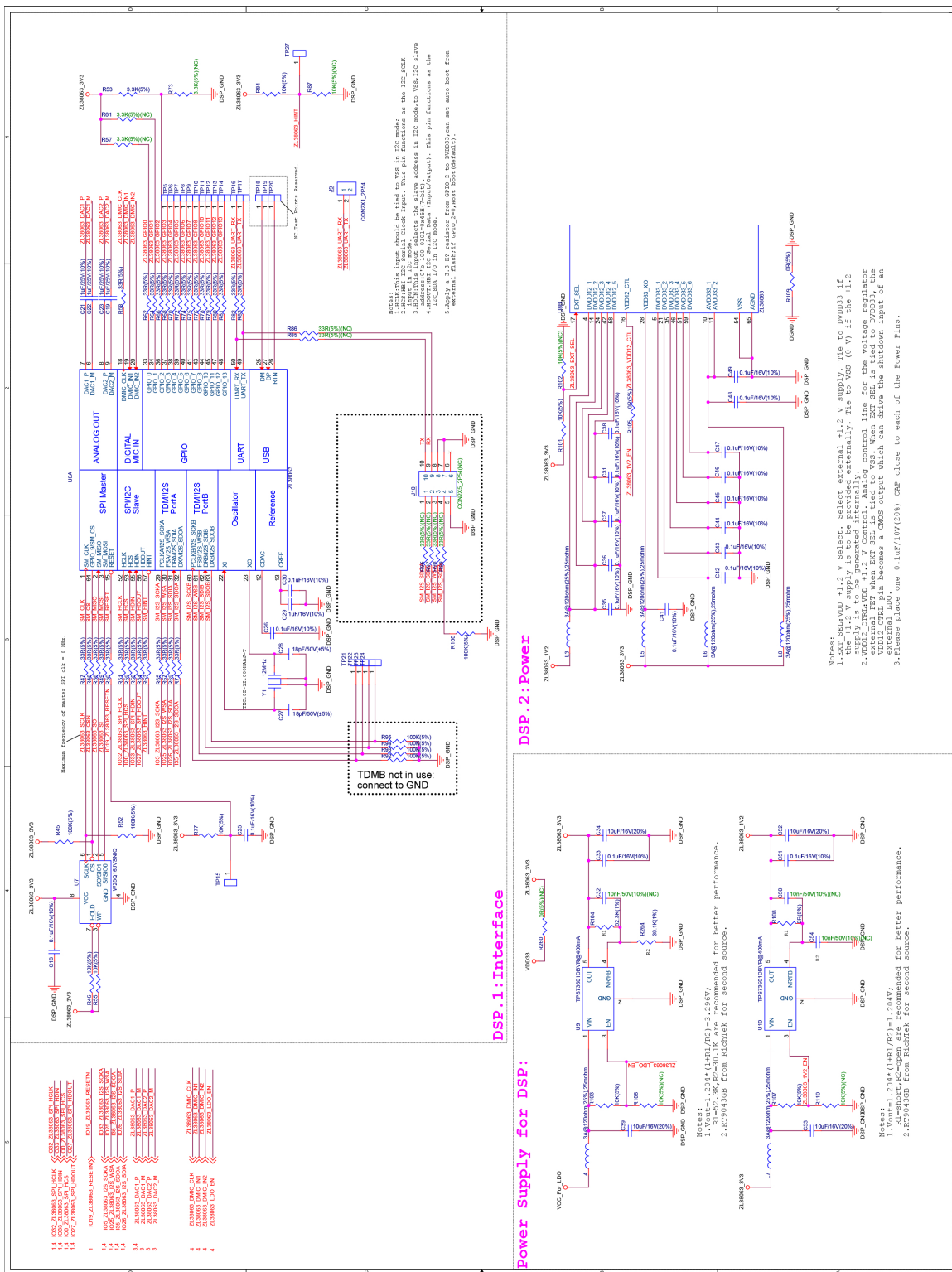

DSP. 1: Interface

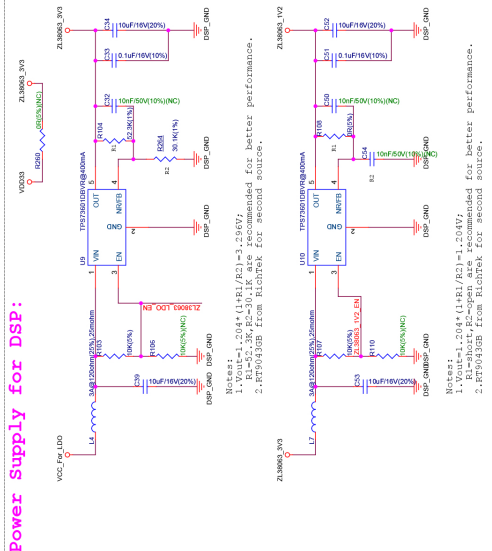

Power Supply for DSP

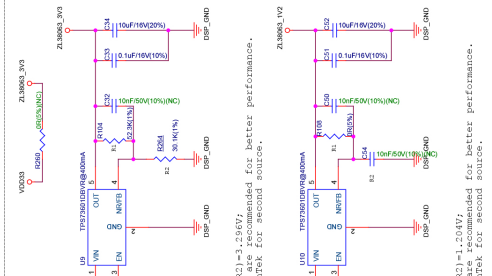

DSP. 2: Power

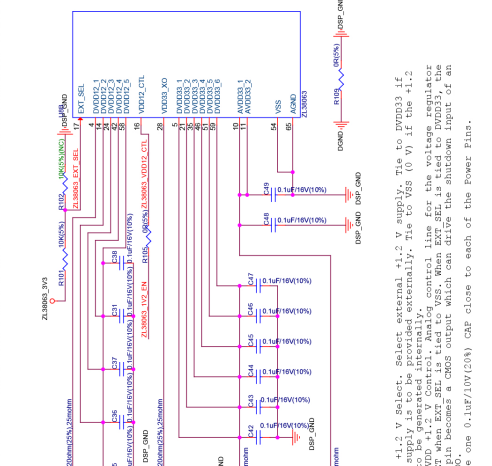

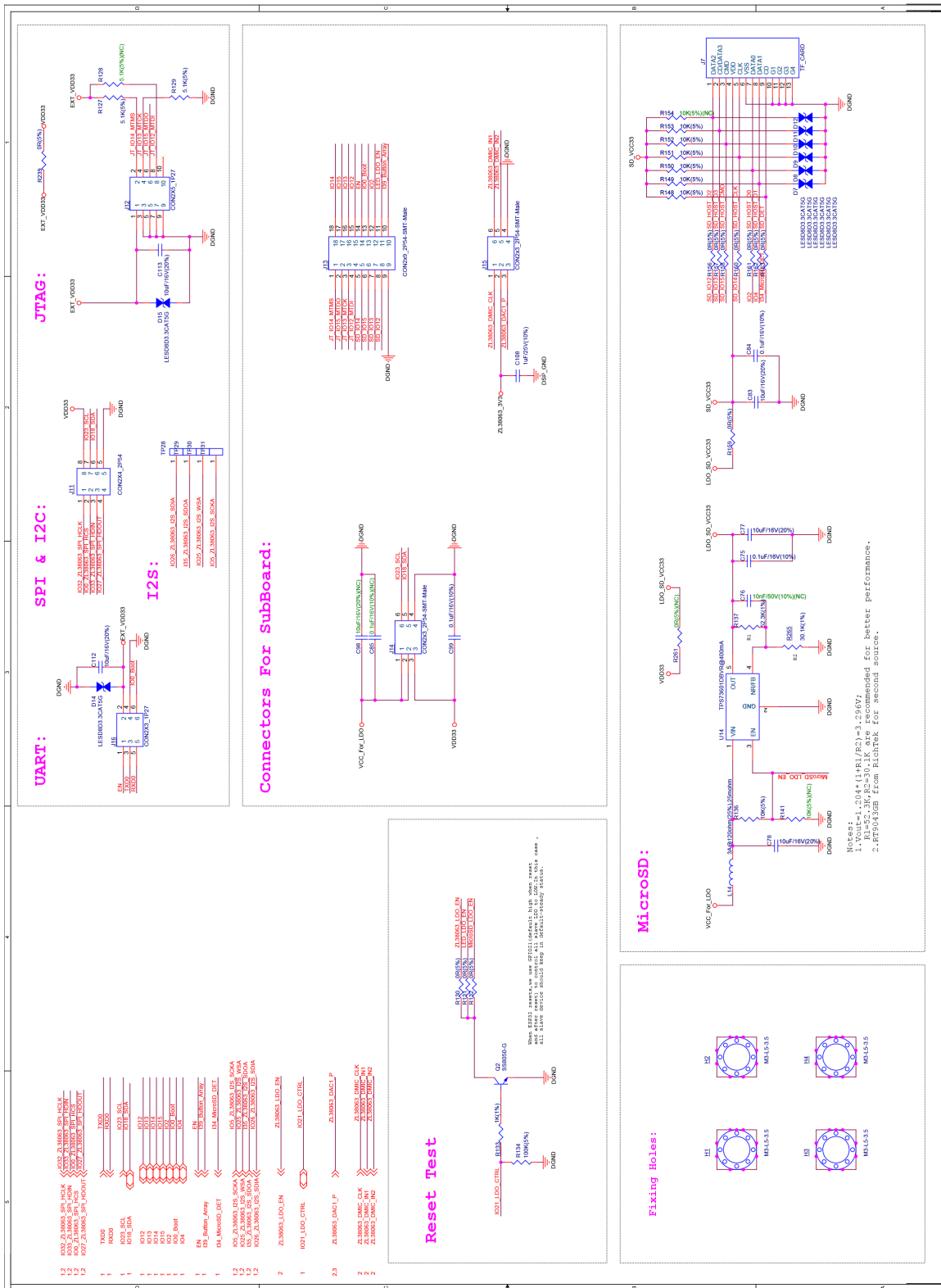



A.2. The lower board (B)

