



EV020A-5-S-00B

85VAC~265VAC/50Hz, 12V/0.7A
Off-line Primary-Side-Regulator
Home Appliances Evaluation Board

DESCRIPTION

The EV020A-5-S-00B Evaluation Board is designed to demonstrate the capabilities of MP020A-5. The MP020A-5 is a primary-side-control offline regulator which can eliminate secondary feedback components.

The EV020A-5-S-00B is typically designed for small home appliances which output 12V, 0.7A load from 85VAC to 265VAC, 50HZ/60HZ.

The EV020A-5-S-00B has an excellent efficiency and meets IEC61000-4-5 surge immunity and EN55022 conducted EMI requirements. It has multi-protection function as open circuit protection, short-circuit protection, cycle by cycle current limit and over-temperature protection, etc.

ELECTRICAL SPECIFICATION

Parameter	Symbol	Value	Units
Input Voltage	V_{IN}	85 to 265	VAC
Output Voltage	V_{OUT}	12	V
Output Current	I_{OUT}	0.7	A
Output Power	P_{OUT}	8.4	W
Efficiency (full load)	η	>80	%

FEATURES

- Primary-Side-Control without Opto-Coupler or Secondary Feedback Circuit
- Precise Constant Current and Constant Voltage Control (CC/CV)
- Integrated 700V MOSFET with Minimal External Components
- Variable, Off-Time, Peak-Current Control
- 550 μ A High-Voltage Current Source
- 100mW No-Load Power Consumption
- Programmable Cable Compensation
- Multiple Protections: OVP, OCP, OCKP, OTP, and VCC UVLO
- Natural Spectrum Shaping for Improved EMI Signature
- Low Cost and Simple External circuit

APPLICATIONS

- Small Home Appliances
- Cell Phone Chargers
- Adapters for Handheld Electronics
- Stand-By and Auxiliary Power Supplies
- Small Appliances

All MPS parts are lead-free and adhere to the RoHS directive. For MPS green status, please visit MPS website under Quality Assurance. "MPS" and "The Future of Analog IC Technology", are Registered Trademarks of Monolithic Power Systems, Inc.



High Voltage

Warning: Although this board is designed to satisfy safety requirements, the engineering prototype has not been agency approved. Therefore, all testing should be performed using an isolation transformer to provide the AC input to the prototype board.

EV020A-5-S-00B EVALUATION BOARD

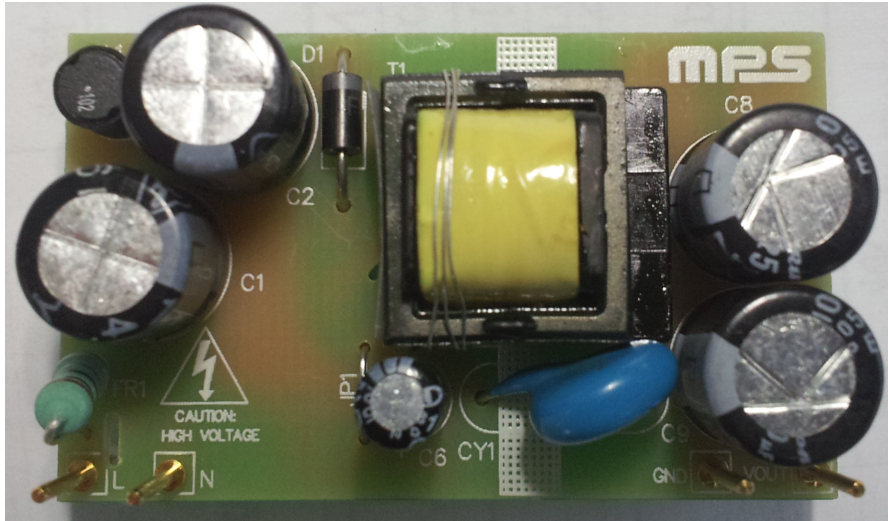

TOP VIEW

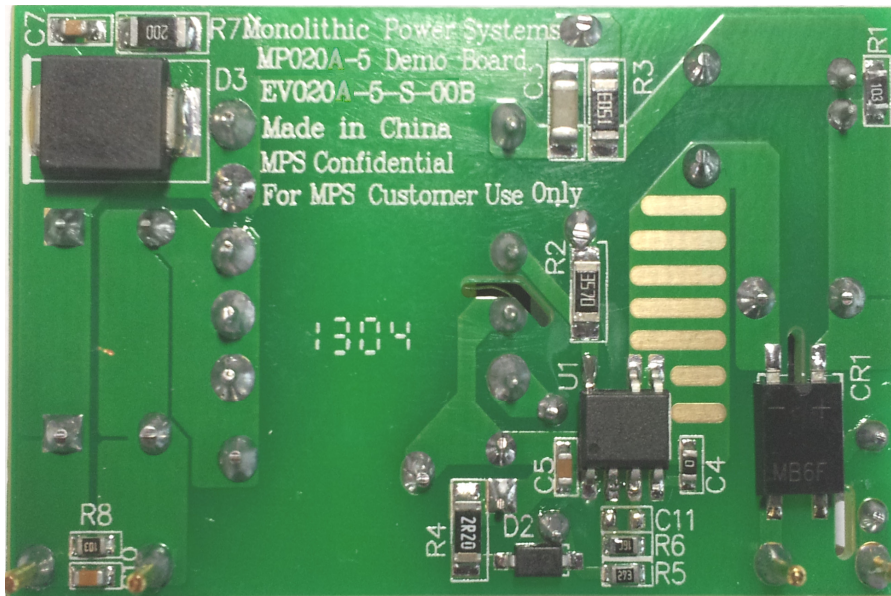

BOTTOM VIEW

(L x W x H) 50mm x 30mm x 18mm

Board Number	MPS IC Number
EV020A-5-S-00B	MP020A-5GS

EVALUATION BOARD SCHEMATIC

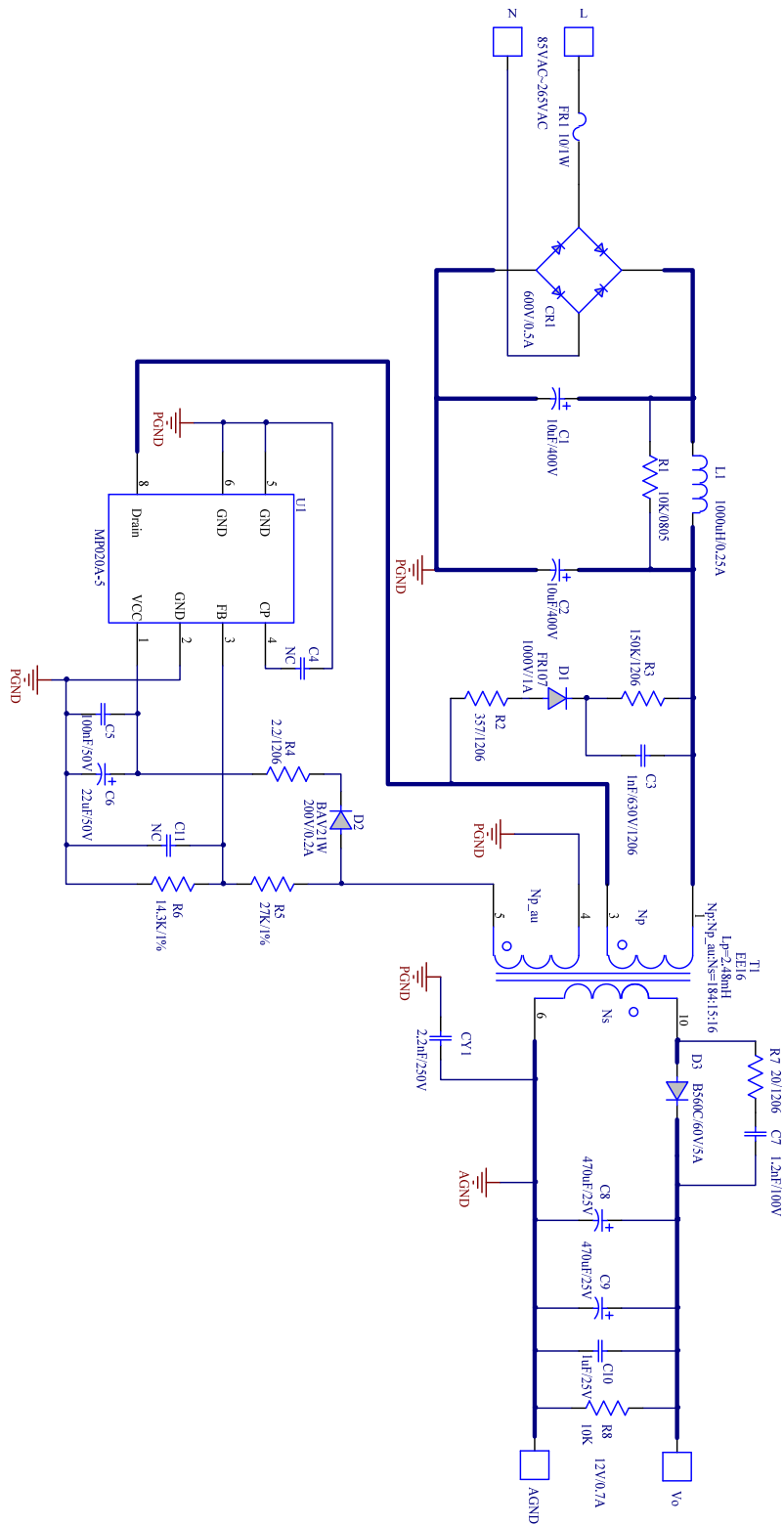

Figure 1—Schematic

PCB LAYOUT (SINGLE-SIDED)

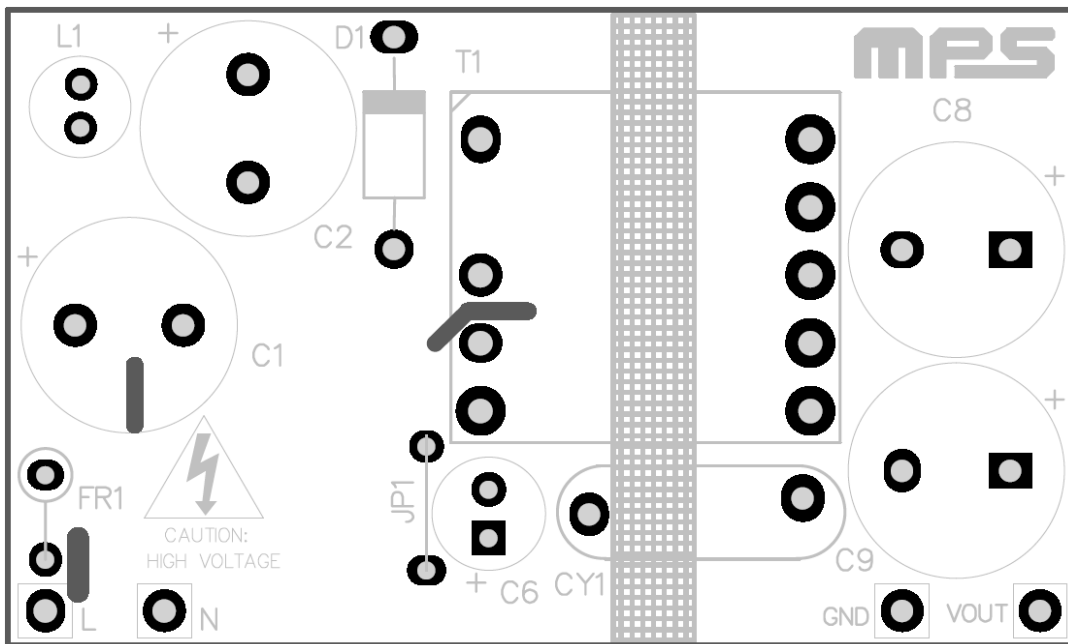

Figure 2—Top Layer

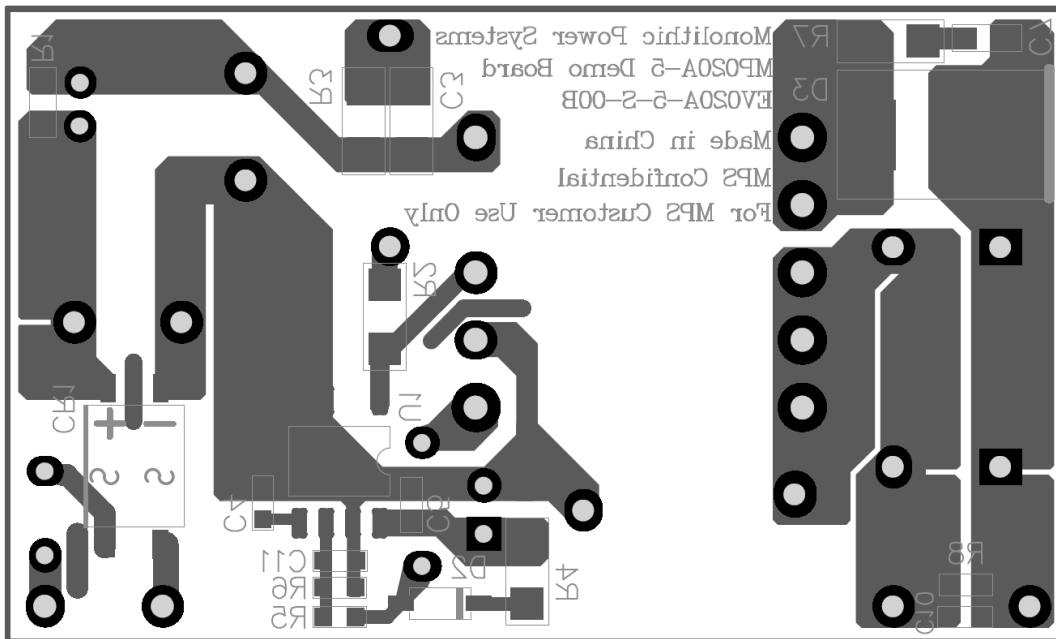

Figure 3—Bottom Layer

CIRCUIT DESCRIPTION

The EV020A-5-S-00B is configured in a single-stage Flyback topology, it uses primary-side-control which can mostly simplify the schematic and get a cost effective BOM. It can also achieve accurate constant voltage and constant current.

FR1 and CR1 compose the input stage. FR1 is used to protect for the component failure or some excessive short events, also it can restrain the inrush current.

C1, L1 and C2 compose π filter to guarantee the conducted EMI meet standard EN55022. R2, R3, D1 and C3 compose the snubber circuit to reduce drain-source voltage spike.

R4, C5, C6 and D2 are used as Vcc power supply.

R5 and R6 are resistor divider for detecting output voltage by sampling voltage on primary auxiliary winding.

CY1 is Y capacitor lowering common mode noise to make sure there is enough EMI margin. T1 is power transformer, the structure of which is also very important to pass EMI test.

D3, C8, C9, C10 and R8 compose output circuit. D3 is schottky diode for better efficiency. C10 is ceramic capacitor for lower output voltage ripple and R8 is dummy load, which is used for good regulation.

R7 and C7 are used to depress the spike of schottky.

EV020A-5-S-00B BILL OF MATERIALS

Qty	Ref	Value	Description	Package	Manufacturer	Manufacturer_P/N
2	C1,C2	10 μ F	Capacitor;400V;20%	DIP	Ltec	TY 10uF/400V
1	C3	1nF	Ceramic Capacitor;630V;X7R	1206	Murata	GRM31A7U2J102JW31D
1	C4	0 Ω	Film Resistor;5%	0603	Yageo	RC0603JR-070RL
1	C5	100nF	Ceramic Capacitor;50V;X7R;	0603	Murata	GCJ188R71H104KA12D
1	C6	22 μ F	Electrolytic Capacitor;50V	DIP	Jianghai	CD281L-50V22
1	C7	1.2nF	Ceramic Capacitor;100V;X7R	0603	muRata	GRM188R72A122KA01D
2	C8,C9	470 μ F	Electrolytic Capacitor;25V,Low ESR	DIP	Rubycon	25ZLF470MEFC10X12.5
1	C10	1 μ F	Ceramic Capacitor;25V;X7R	0603	Murata	GRM188R71E105KA12D
1	C11	NC				
1	CY1	2.2nF	Y Capacitor; 250V	DIP	Hongke	JNK12E222ML02N
1	CR1	MB6F	Diode;600V;0.5A	SOP-4	Diodes	MB6F
1	D1	FR107	Diode;1000V;1A	DO-41	Diodes	FR107
1	D2	BAV21W	Diode;200V;0.2A;	SOD-123	Diodes	BAV21W-7-F
1	D3	B560C	Schottky Diode;60V;5A	SMC	Diodes	B560C
1	FR1	10 Ω	Fusible Resistor, 1 W, 5%	Yageo	DIP	FKN1WSJT-52-10R
1	L1	1000 μ H	Inductor;1000uH;6 Ohm;0.25A	DIP	Wurth	7447462102
1	R1	10k Ω	Film Resistor;5%	0805	Yageo	RC0805JR-0710KL
1	R2	357 Ω	Film Resistor;1%;1/4W	1206	Yageo	RC1206FR-07357RL
1	R3	150k Ω	Film Resistor; 1%,1/4W	1206	Yageo	RC1206FR-07150KL
1	R4	2.2 Ω	Film Resistor;5%;1/4W	1206	Royalohm	1206F220KT5E
1	R5	27k Ω	Film Resistor;1%;	0603	Yageo	RC0603FR-0727KL
1	R6	14.3k Ω	Film Resistor;1%	0603	Yageo	RC0603FR-0714K3L
1	R7	20 Ω	Film Resistor;5%;1/4W	1206	Royalohm	1206J020A0T5E
1	R8	10k Ω	Film Resistor;5%;	0603	Yageo	RC0603JR-0710K
1	U1		Primary side regulator	SOIC8-7A	MPS	MP020A-5GS R3
1	T1		Transformer;2.48mH; N _P :N _P :N _{AU} :N _S =184:15:16	EE16	Wurth ⁽¹⁾	7508110328
					Emei ⁽²⁾	FX0303
Notes:		(1) Wurth transformer sample request please login on website: www.we-online.com				
		(2) Emei transformer sample request please login on website: www.emeigroup.com				

TRANSFORMER SPECIFICATION

Electrical Diagram

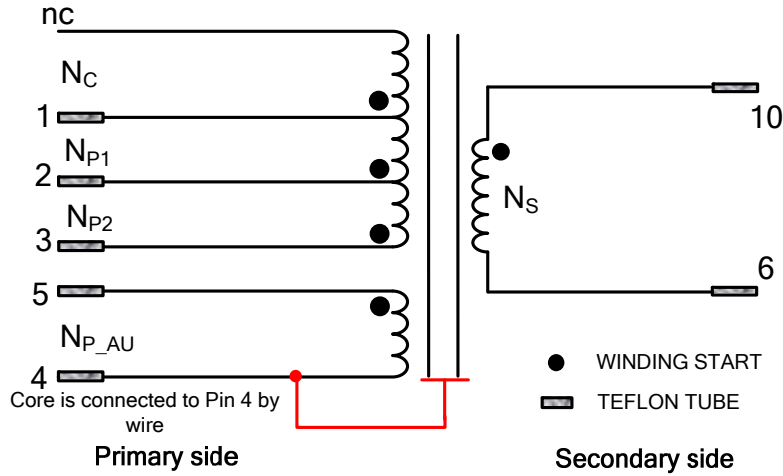

Figure 4—Transformer Electrical Diagram

Notes:

- 1) Core is connected with Pin 4 with naked wire.
- 2) N_S is with Triple Insulation Wire.

Winding Diagram

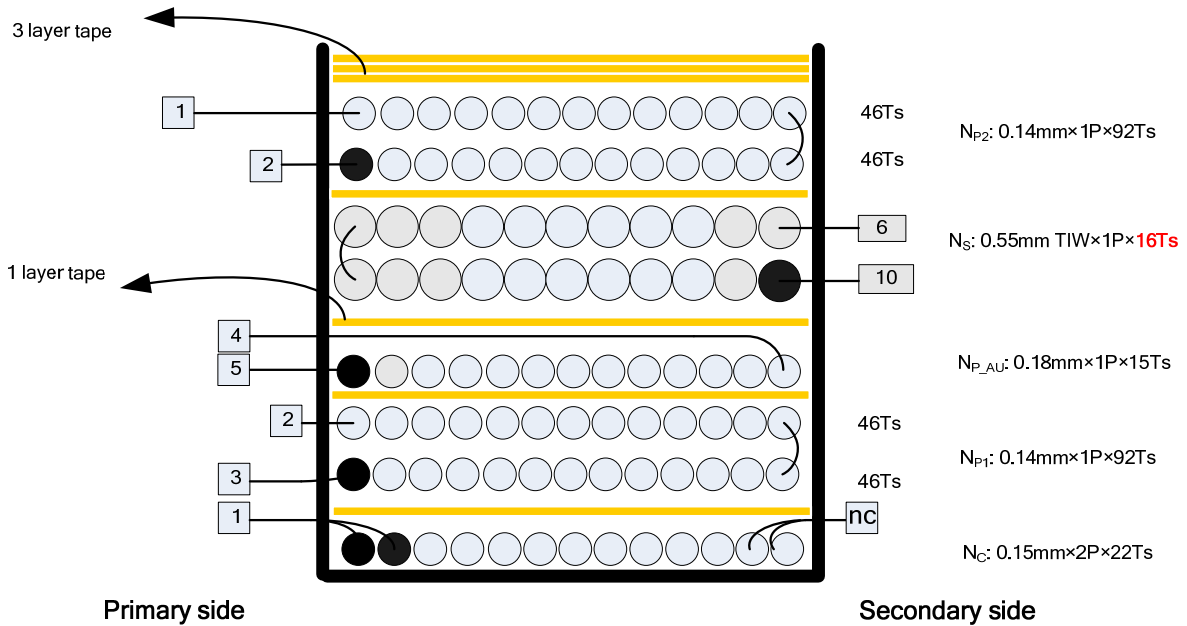

Figure 5—Winding Diagram

Winding Order

Winding No.	Tape Layer Number	Start & End	Magnet WireΦ(mm)	Turns
N _C	1	1→nc	0.15mm * 2	22
N _{P1}	1	3→2	0.14mm * 1	92
N _{P_AU}	1	5→4	0.18mm * 1	15
N _S	1	10→6	0.55mm * 1 TIW	16
N _{P2}	1	2→1	0.14mm * 1	92

Electrical Specifications

Electrical Strength	60 second, 60Hz, from PRI. to SEC.	3000VAC
	60 second, 60Hz, from PRI. to CORE.	500VAC
	60 second, 60Hz, from SEC. to CORE.	3000VAC
Primary Inductance	Pins 1 - 3, all other windings open, measured at 50kHz, 0.1 VRMS	2.48mH±10%
Primary Leakage Inductance	Pins 1 - 3 with all other pins shorted, measured at 50kHz. 0.1 VRMS	60μH±10%

Materials

Item	Description
1	Core: EE16, UI=2300±25%, AL=73.2.4nH/N ² ±3% GAPPED, or equivalent
2	Bobbin: EE16, 5+5PIN 1 SECT TH, UL94V-0
3	Wire:Φ0.14mm,, 2UEW, Class B
4	Wire:Φ0.15mm,, 2UEW, Class B
5	Wire:Φ0.18mm,, 2UEW, Class B
6	Triple Insulation Wire: Φ0.55mm TIW
7	Tape: 8.0mm(W)×0.06mm(TH)
8	Varnish: JOHN C. DOLPH CO, BC-346A or equivalent

EVB TEST RESULTS

Performance Data

T_A=25°C, unless otherwise noted.

Efficiency

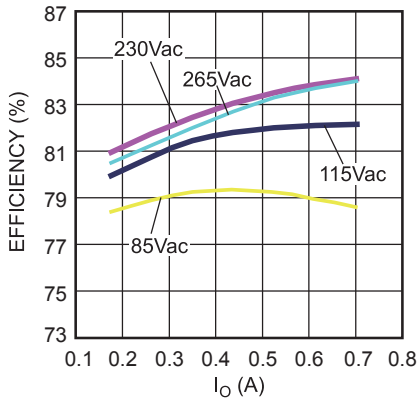

No Load Consumption

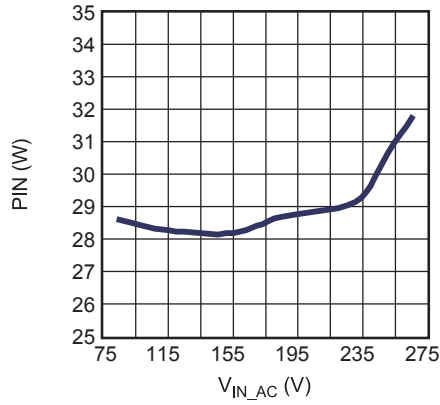

Line Regulation

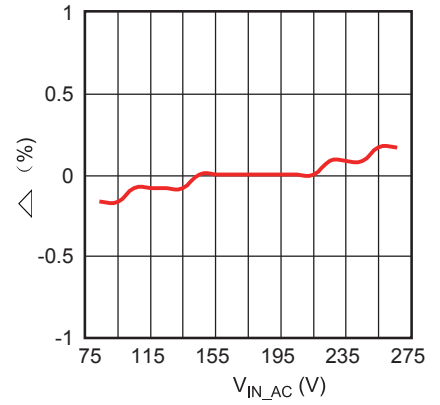

Load Regulation

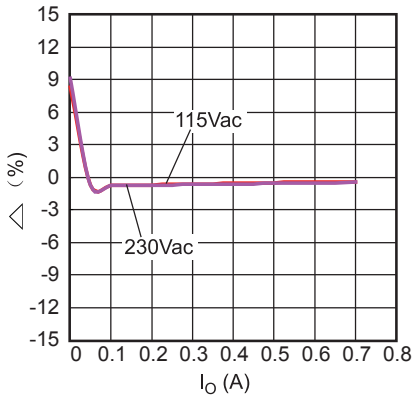

Electric Strength Test

Primary circuit to secondary circuit electric strength testing was completed according to IEC61000-4-2

Input and output was shorted respectively. 3000VAC/50Hz sine wave applied between input and output for 1min, and operation was verified.

Surge Test

Line to Line 1kV and Line to Power Earth 1kV surge testing was completed according to IEC61000-4-5. Input voltage was set at 220VAC/50Hz. Output was loaded at full load and operation was verified following each surge event.

Surge Level (V)	Input Voltage (VAC)	Injection Location	Injection Phase (°)	Test Result (Pass/Fail)
1000	220	L to N	90	Pass
-1000	220	L to N	270	Pass
1000	220	L to PE	90	Pass
-1000	220	L to PE	270	Pass
1000	220	N to PE	90	Pass
-1000	220	N to PE	270	Pass

Conducted EMI Test

Test with 230Vac input and full load condition

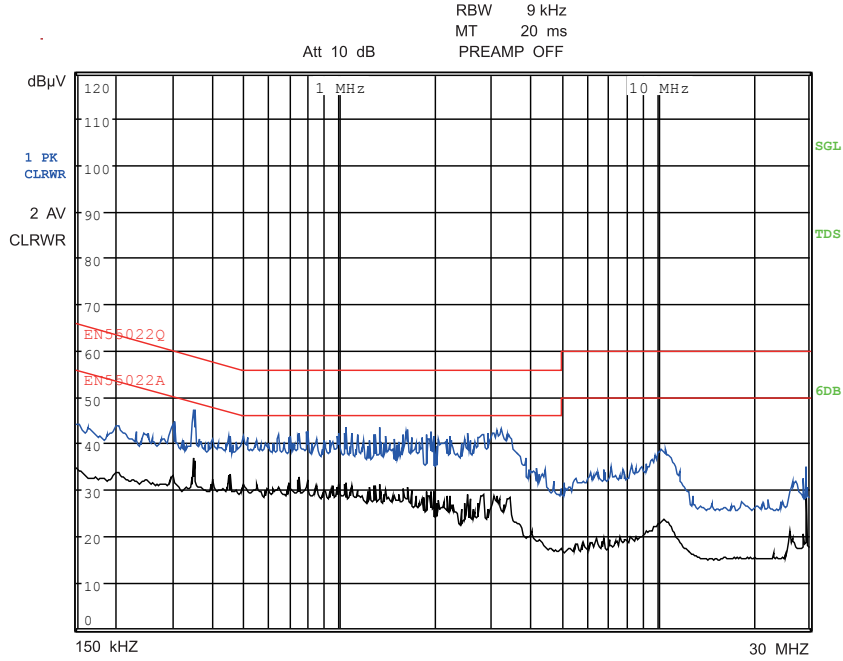

230Vac, 50Hz, Maximum Load, L Line, EN5022 Limits

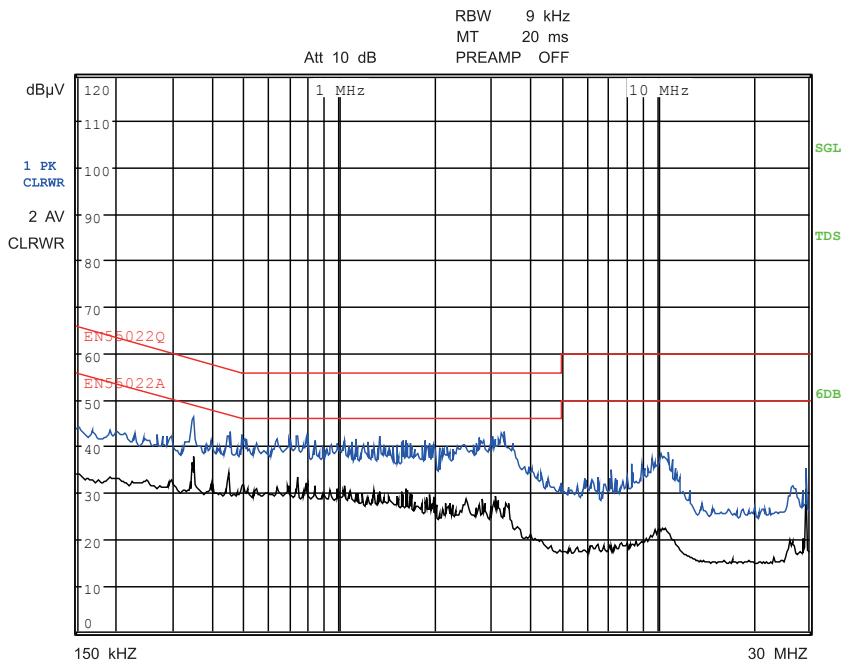

230Vac, 50Hz, Maximum Load, N Line, EN5022 Limits

Conducted EMI Test (continued)

Test with 115Vac input and full load condition

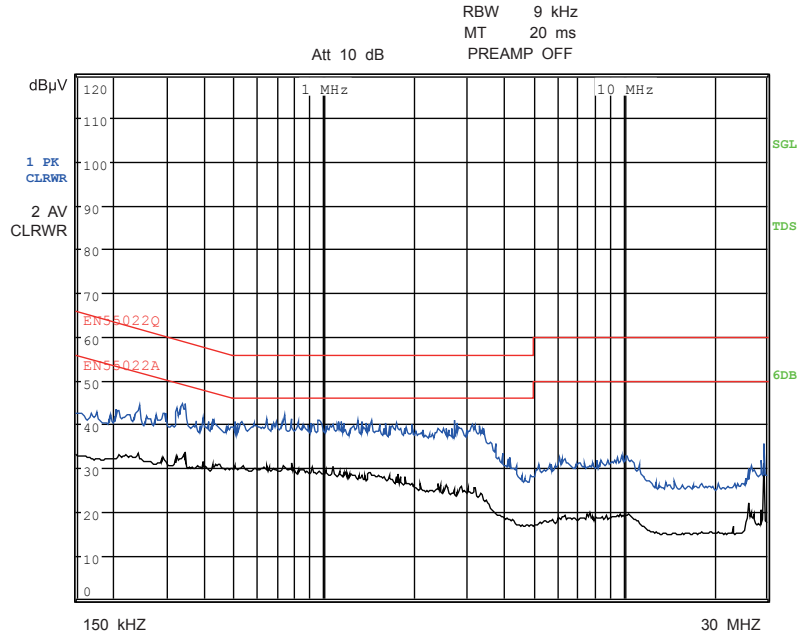

115Vac, 60Hz, Maximum Load, L Line, EN55022 Limits

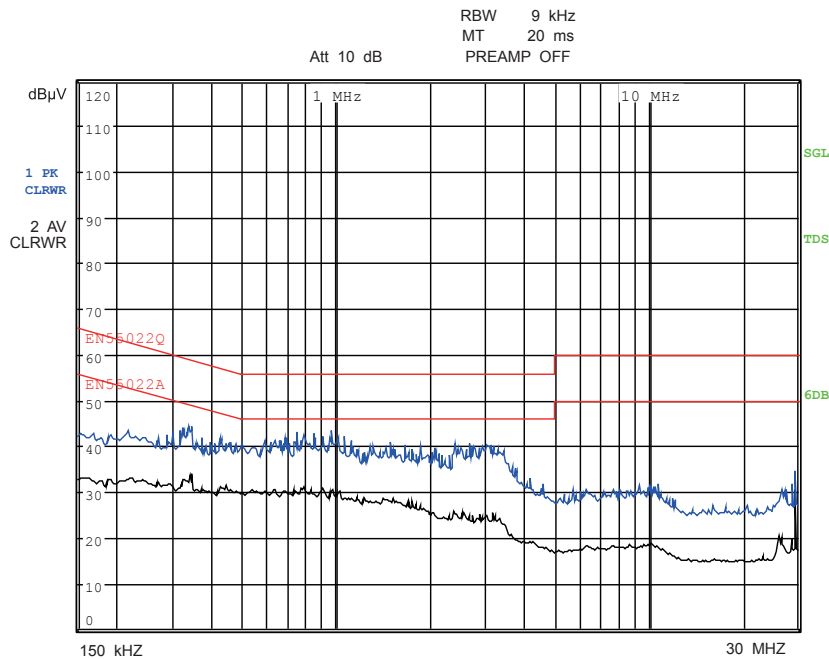

115Vac, 60Hz, Maximum Load, N Line, EN55022 Limits

Thermal Test

Test with 85Vac input and full load condition. PCB layout is with 1Oz copper. Ambient temperature is 25°C.

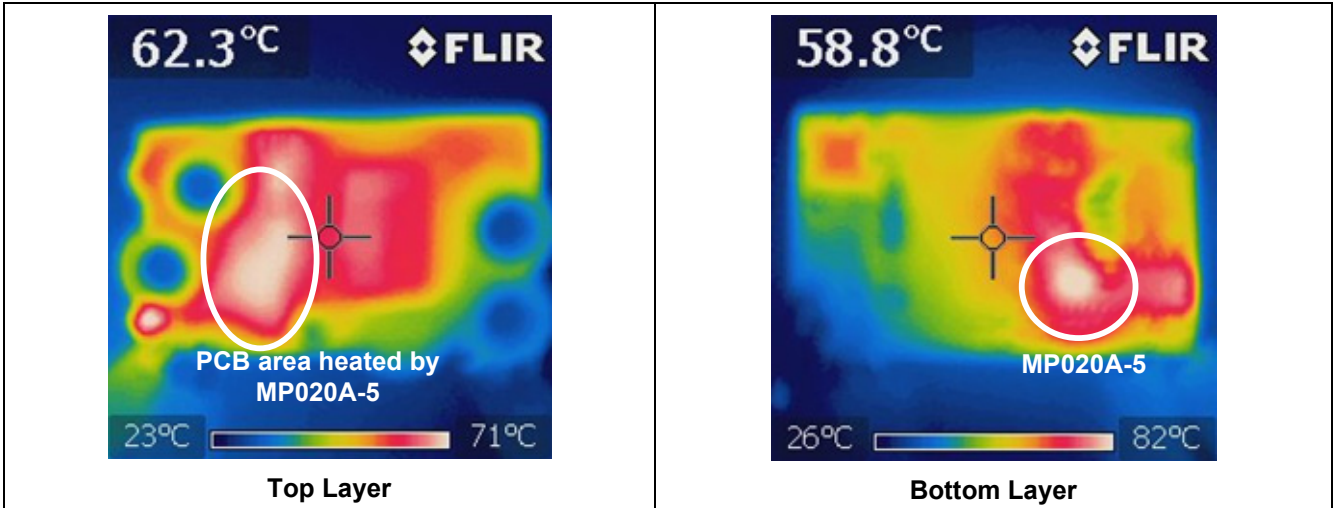

Test with 265Vac input and full load condition. PCB layout is with 1Oz copper. Ambient temperature is 25°C.

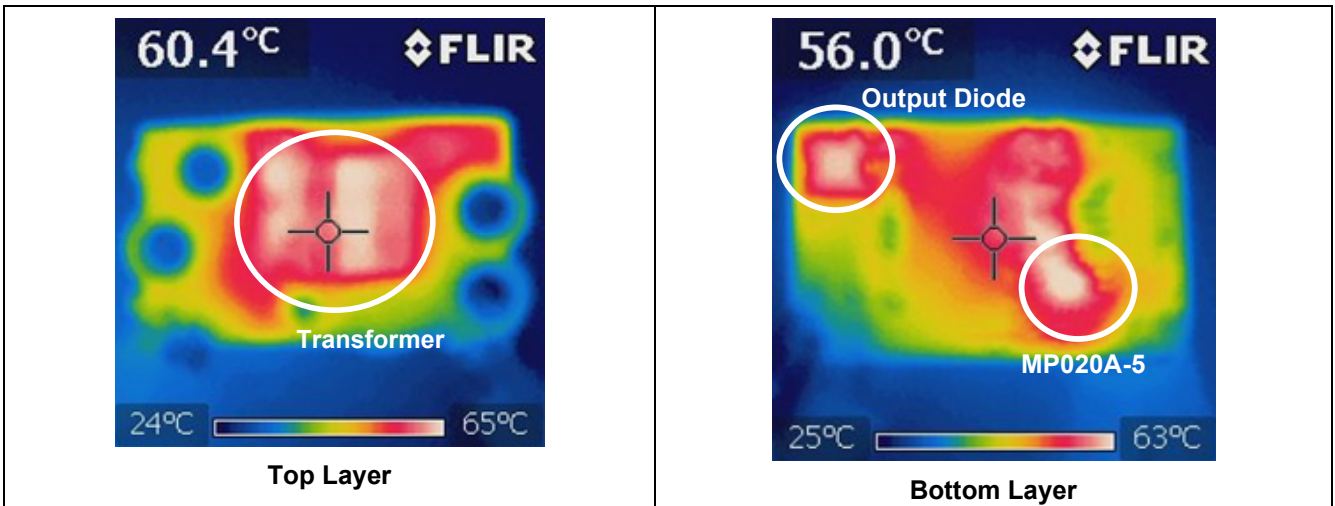

EVB TEST RESULTS

Performance waveforms are tested on the evaluation board.

$V_{IN}=115VAC/60Hz$, $V_{OUT}=12V$, $I_{OUT}=0.7A$, $L_P=2.48mH$, $N_P:N_{P_AU}:N_S=184:15:16$, $T_A=25^\circ C$, unless otherwise noted.

Steady State

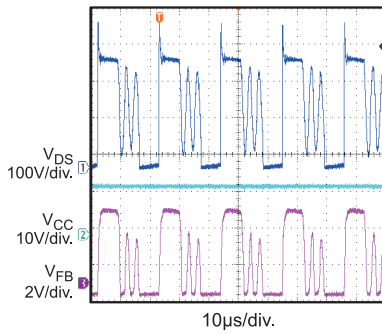

Turn On Delay

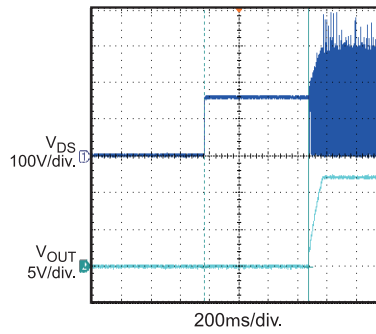

Output Rise Time

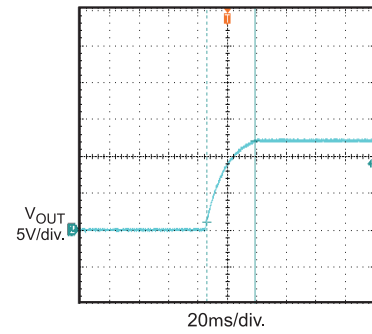

Output Ripple

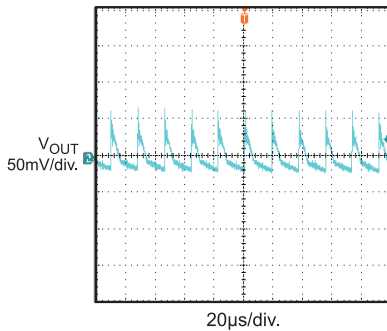

SCP Enter

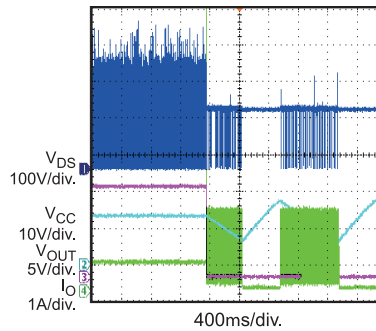

SCP Recovery

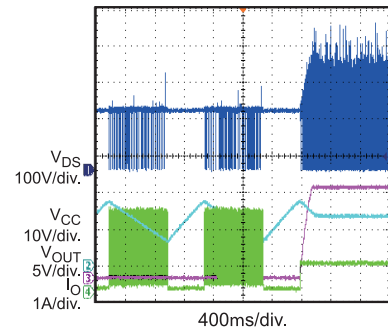

OckP Enter

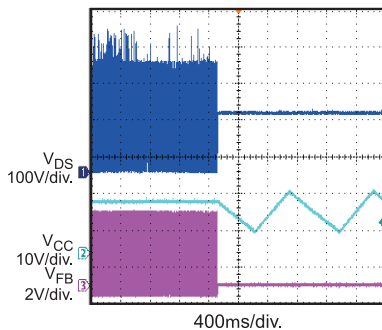

OckP Recovery

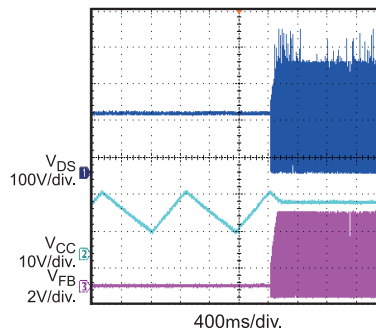

OLP Enter

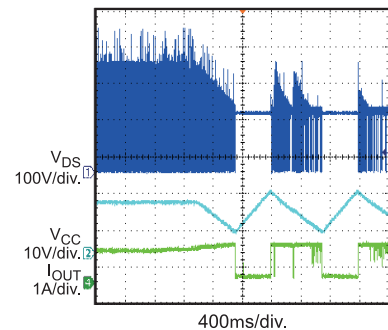

EVB TEST RESULTS *(continued)*

Performance waveforms are tested on the evaluation board.

$V_{IN}=115VAC/60Hz$, $V_{OUT}=12V$, $I_{OUT}=0.7A$, $L_P=2.48mH$, $N_P:N_{P_AU}:N_S=184:15:16$, $T_A=25^\circ C$, unless otherwise noted.

OLP Recovery

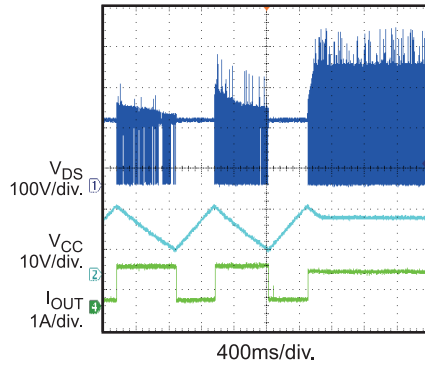

Load Transient

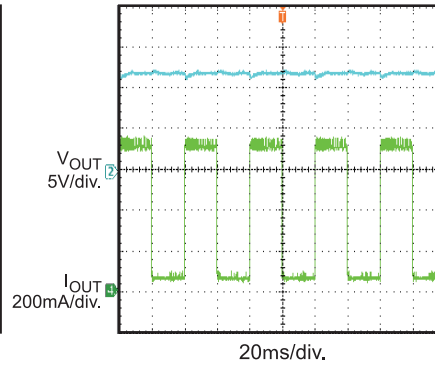

EVB TEST RESULTS *(continued)*

Performance waveforms are tested on the evaluation board.

$V_{IN}=230VAC/50Hz$, $V_{OUT}=12V$, $I_{OUT}=0.7A$, $L_P=2.48mH$, $N_P:N_{P_AU}:N_S=184:15:16$, $T_A=25^\circ C$, unless otherwise noted.

Steady State

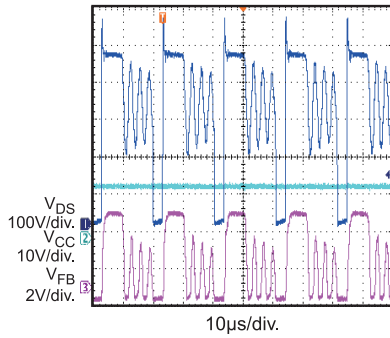

Turn On Delay

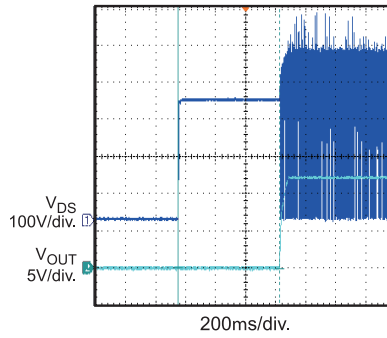

Output Rise Time

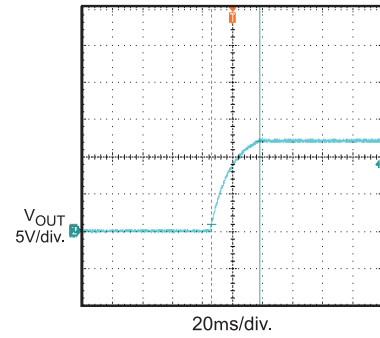

Output Ripple

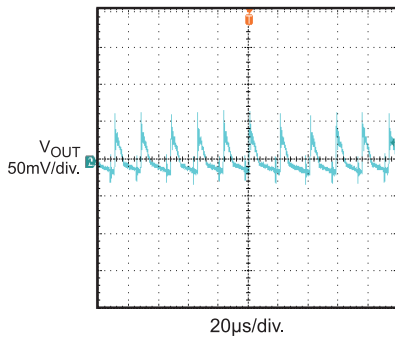

SCP Enter

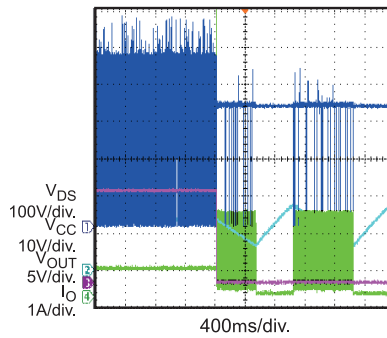

SCP Recovery

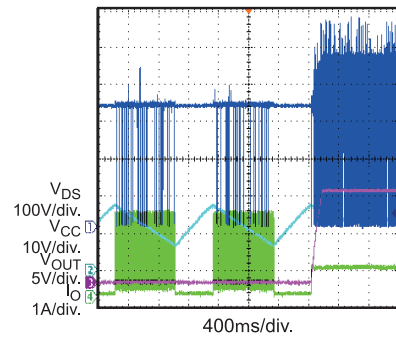

OCP Enter

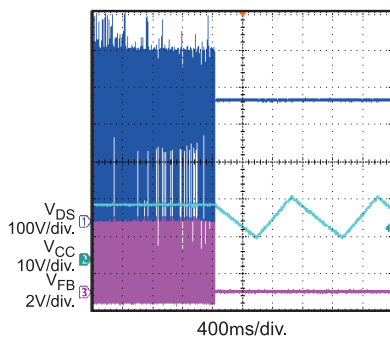

OCP Recovery

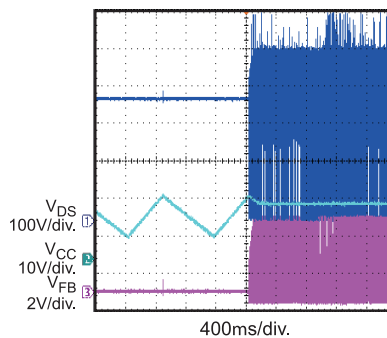

OLP Enter

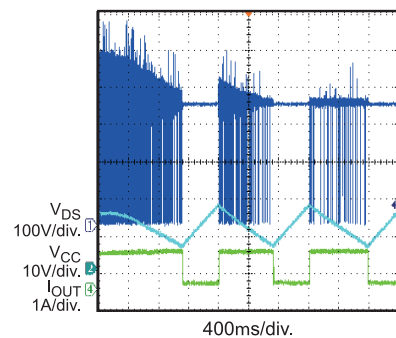

EVB TEST RESULTS *(continued)*

Performance waveforms are tested on the evaluation board.

$V_{IN}=230VAC/50Hz$, $V_{OUT}=12V$, $I_{OUT}=0.7A$, $L_P=2.48mH$, $N_P:N_{P_AU}:N_S=184:15:16$, $T_A=25^\circ C$, unless otherwise noted.

OLP Recovery

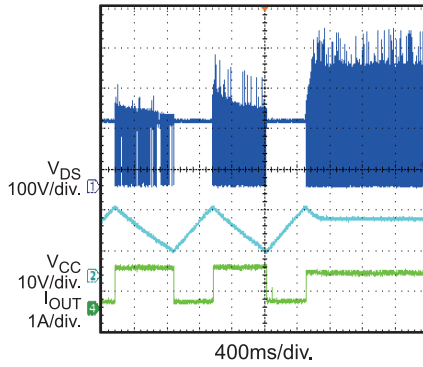

Load Transient

