

FEATURES

Passive; no dc bias required

Conversion loss

8 dB typical for 10 GHz to 18 GHz

9 dB typical for 18 GHz to 26 GHz

LO to RF isolation: 40 dB

Input IP3: 19 dBm typical for 18 GHz to 26 GHz

Wide IF bandwidth: dc to 8 GHz

RoHS compliant, 12-terminal, 3 mm × 3 mm, ceramic

LCC package: 9 mm²

APPLICATIONS

Point to point radios

Point to multipoint radios and very small aperture terminals
(VSATs)

Test equipment and sensors

Military end use

GENERAL DESCRIPTION

The HMC260ALC3B is a general-purpose, double balanced, monolithic microwave integrated circuit (MMIC) mixer housed in a leadless, Pb-free, RoHS compliant LCC package. The device can be used as an upconverter or downconverter in the 10 GHz to 26 GHz frequency range. The HMC260ALC3B mixer requires no external components or matching circuitry.

FUNCTIONAL BLOCK DIAGRAM

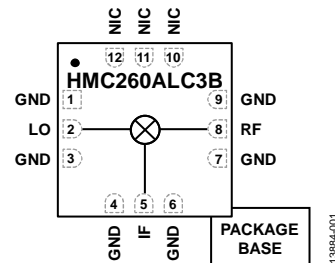

Figure 1.

The HMC260ALC3B provides local oscillator (LO) to radio frequency (RF) and LO to intermediate frequency (IF) suppression due to optimized balun structures. The mixer operates with LO amplitude levels between 9 dBm and 15 dBm. The HMC260ALC3B eliminates the need for wire bonding, allowing the use of surface-mount manufacturing techniques.

TABLE OF CONTENTS

Features	1	Upconverter Performance	8
Applications	1	Isolation and Return Loss	9
Functional Block Diagram	1	IF Bandwidth—Downconverter	11
General Description	1	IF Bandwidth—Upconverter	12
Revision History	2	Spurious and Harmonics Performance	13
Specifications	3	Theory of Operation	14
Absolute Maximum Ratings	4	Applications Information	15
Thermal Resistance	4	Typical Application Circuit	15
ESD Caution	4	Evaluation PCB Information	15
Pin Configuration and Function Descriptions	5	Outline Dimensions	16
Interface Schematics	5	Ordering Guide	16
Typical Performance Characteristics	6		
Downconverter Performance	6		

REVISION HISTORY

1/2018—Revision 0: Initial Version

SPECIFICATIONS

Ambient temperature (T_A) = 25°C, IF = 1000 MHz, LO = 13 dBm, upper sideband. All measurements performed as a downconverter on the evaluation printed circuit board (PCB), unless otherwise noted.

Table 1.

Parameter	Symbol	Min	Typ	Max	Unit	Test Conditions/Comments
FREQUENCY RANGE						
RF		10		26	GHz	
LO Input		10		26	GHz	
IF		dc		8	GHz	
LO AMPLITUDE						
		9	13	15	dBm	
10 GHz TO 18 GHz PERFORMANCE						
Downconverter						
Conversion Loss			8	10	dB	
Single Sideband Noise Figure	SSB NF		8		dB	
Input Third-Order Intercept	IIP3	13	18		dBm	
Input 1 dB Compression Point	IP1dB		9.5		dBm	
Input Second-Order Intercept	IIP2		43		dBm	
Upconverter						
Conversion Loss			7		dB	
Input Third-Order Intercept	IIP3		18		dBm	
Input 1 dB Compression Point	IP1dB		7		dBm	
Isolation						
RF to IF		14	21		dB	
LO to RF			40		dB	
LO to IF		25	35		dB	
18 GHz TO 26 GHz PERFORMANCE						
Downconverter						
Conversion Loss			9	12	dB	
Single Sideband Noise Figure	SSB NF		10		dB	
Input Third-Order Intercept	IIP3	18	23		dBm	
Input 1 dB Compression Point	IP1dB		13		dBm	
Input Second-Order Intercept	IIP2		46		dBm	
Upconverter						
Conversion Loss			8		dB	
Input Third-Order Intercept	IIP3		19		dBm	
Input 1 dB Compression Point	IP1dB		8.5		dBm	
Isolation						
RF to IF		25	35		dB	
LO to RF			40		dB	
LO to IF		30	43		dB	

ABSOLUTE MAXIMUM RATINGS

Table 2.

Parameter	Rating
RF Input Power	25 dBm
LO Input Power	27 dBm
IF Input Power	25 dBm
IF Source/Sink Current	3 mA
Peak Reflow Temperature	260°C
Continuous Power Dissipation, P_{Diss} ($T_A = 85^\circ\text{C}$, Derate 5 mW/ $^\circ\text{C}$ Above 85°C)	260 mW
Operating Temperature Range	-40°C to +85°C
Storage Temperature Range	-65°C to +150°C
Lead Temperature Range	-65°C to +150°C
Electrostatic Discharge (ESD) Sensitivity	
Human Body Model	500 V
Field Induced Charged Device Model	1000 V

Stresses at or above those listed under Absolute Maximum Ratings may cause permanent damage to the product. This is a stress rating only; functional operation of the product at these or any other conditions above those indicated in the operational section of this specification is not implied. Operation beyond the maximum operating conditions for extended periods may affect product reliability.

THERMAL RESISTANCE

Thermal performance is directly linked to printed circuit board (PCB) design and operating environment. Careful attention to PCB thermal design is required.

θ_{JA} is the natural convection junction to ambient thermal resistance measured in a one cubic foot sealed enclosure. θ_{JC} is the junction to case thermal resistance.

Table 3. Thermal Resistance

Package Type	θ_{JA}	θ_{JC}	Unit
E-12-4 ¹	120	200	$^\circ\text{C}/\text{W}$

¹ See JEDEC standard JESD51-2 for additional information on optimizing the thermal impedance (PCB with 3 × 3 vias).

ESD CAUTION



ESD (electrostatic discharge) sensitive device. Charged devices and circuit boards can discharge without detection. Although this product features patented or proprietary protection circuitry, damage may occur on devices subjected to high energy ESD. Therefore, proper ESD precautions should be taken to avoid performance degradation or loss of functionality.

PIN CONFIGURATION AND FUNCTION DESCRIPTIONS

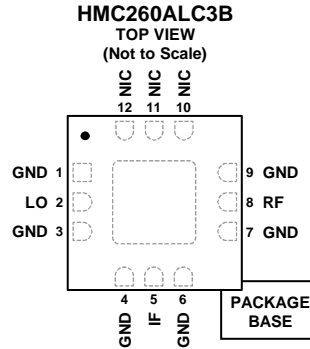

NOTES
 1. NIC = NOT INTERNALLY CONNECTED. THESE PINS CAN BE CONNECTED TO RF/DC GROUND. PERFORMANCE IS NOT AFFECTED.
 2. EXPOSED PAD. THE EXPOSED PAD MUST BE CONNECTED TO RF/DC GROUND.

Figure 2.

Table 4. Pin Function Descriptions

Pin No.	Mnemonic	Description
1, 3, 4, 6, 7, 9	GND	Ground. These pins and package bottoms connect to RF/dc ground.
2	LO	Local Oscillator Port. This pin is ac-coupled and matched to 50 Ω.
5	IF	Intermediate Frequency Port. This pin is dc-coupled. For applications, not requiring operation to dc, dc block this port externally using a series capacitor of a value chosen to pass the necessary IF frequency range. For operation to dc, this pin must not source or sink more than 3 mA of current or die malfunction and possible die failure may result. See Figure 5 for the interface schematic.
8	RF	Radio Frequency Port. This pin is ac-coupled and matched to 50 Ω.
10 to 12	NIC EPAD	Not Internally Connected. These pins can be connected to RF/dc ground. Device performance is not affected. Exposed Pad. The exposed pad must be connected to RF/dc ground.

INTERFACE SCHEMATICS



Figure 3. GND Interface Schematic

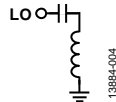

Figure 4. LO Interface Schematic

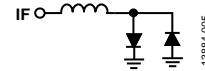

Figure 5. IF Interface Schematic

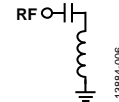

Figure 6. RF Interface Schematic

TYPICAL PERFORMANCE CHARACTERISTICS

DOWNCONVERTER PERFORMANCE

Downconverter performance at IF = 1000 MHz, upper sideband (low-side LO).

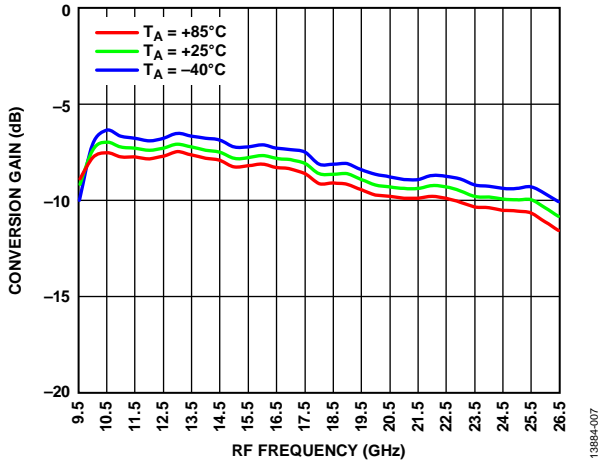

Figure 7. Conversion Gain vs. RF Frequency at Various Temperatures, LO = 13 dBm

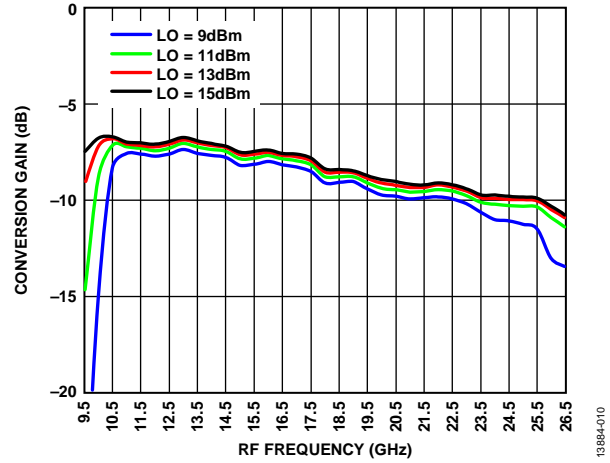

Figure 10. Conversion Gain vs. RF Frequency at Various LO Power Levels, TA = 25°C

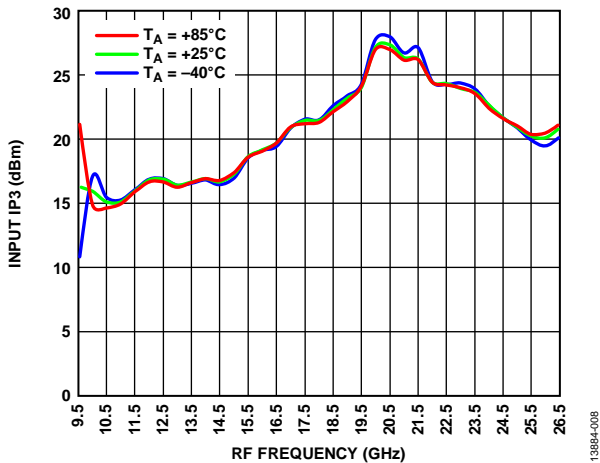

Figure 8. Input IP3 vs. RF Frequency at Various Temperatures, LO = 13 dBm

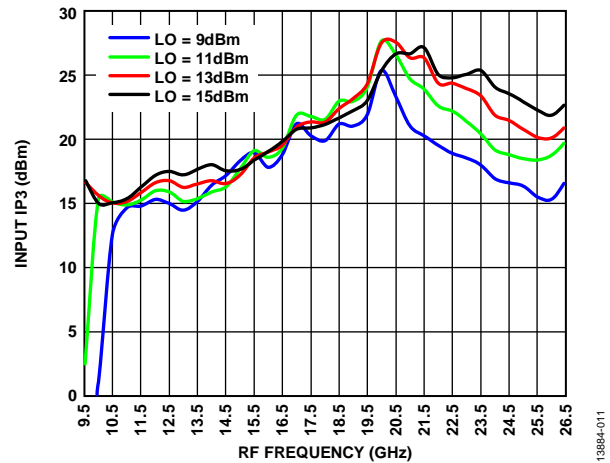

Figure 11. Input IP3 vs. RF Frequency at Various LO Power Levels, TA = 25°C

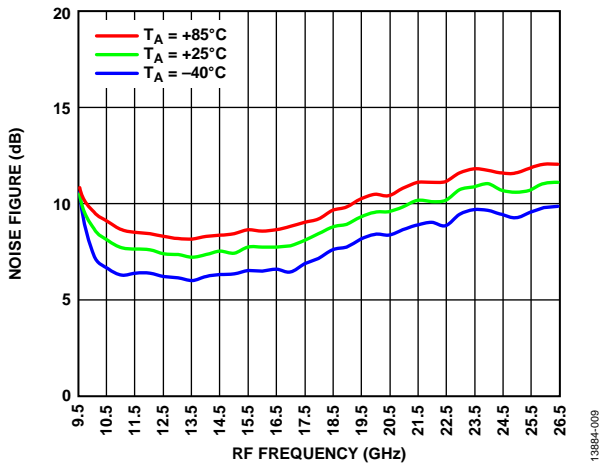

Figure 9. Noise Figure vs. RF Frequency at Various Temperatures, LO = 13 dBm

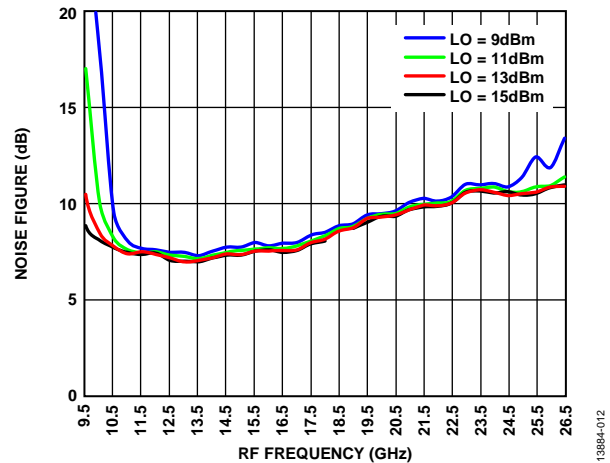

Figure 12. Noise Figure vs. RF Frequency at Various LO Power Levels, TA = 25°C

Downconverter P1dB and IP2

IF = 1000 MHz, upper sideband (low-side LO).

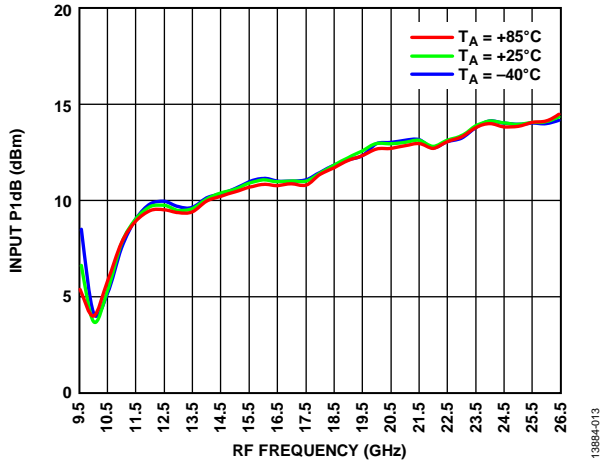

Figure 13. Input P1dB vs. RF Frequency at Various Temperatures, LO = 13 dBm

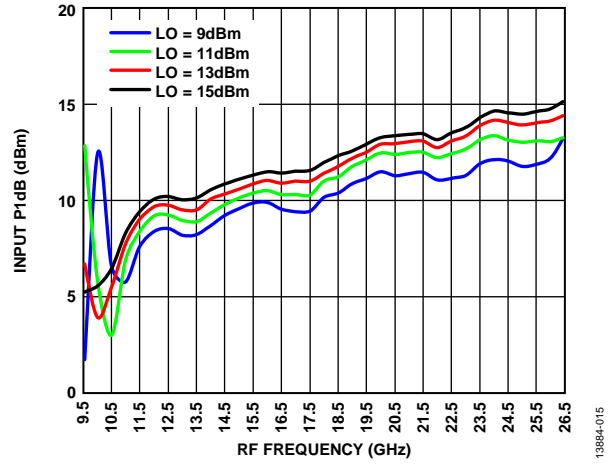

Figure 15. Input P1dB vs. RF Frequency at Various LO Power Levels, TA = 25°C

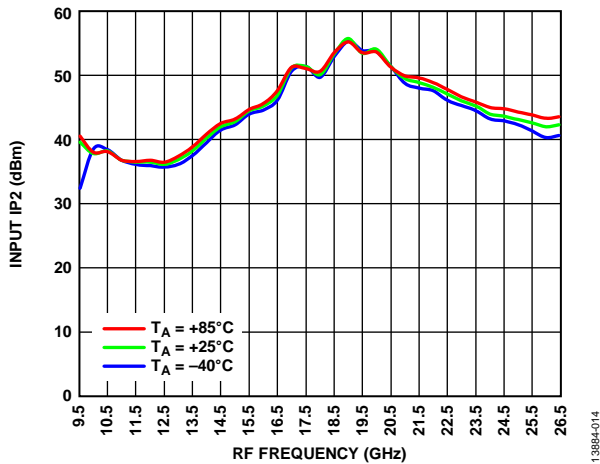

Figure 14. Input IP2 vs. RF Frequency at Various Temperatures, LO = 13 dBm

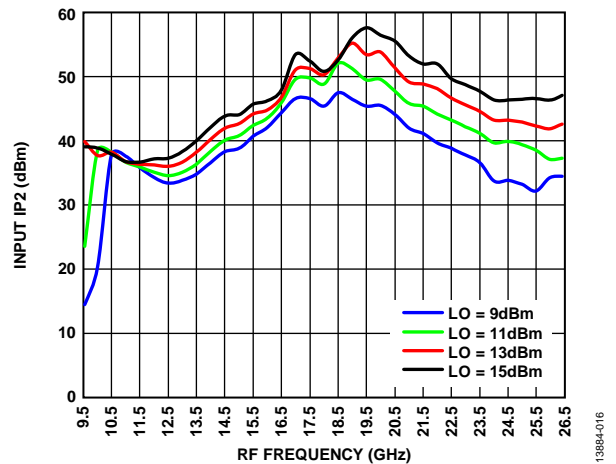

Figure 16. Input IP2 vs. RF Frequency at Various LO Power Levels, TA = 25°C

UPCONVERTER PERFORMANCE

Upconverter performance at input intermediate frequency (IF_{IN}) = 1000 MHz, upper sideband (low-side LO).

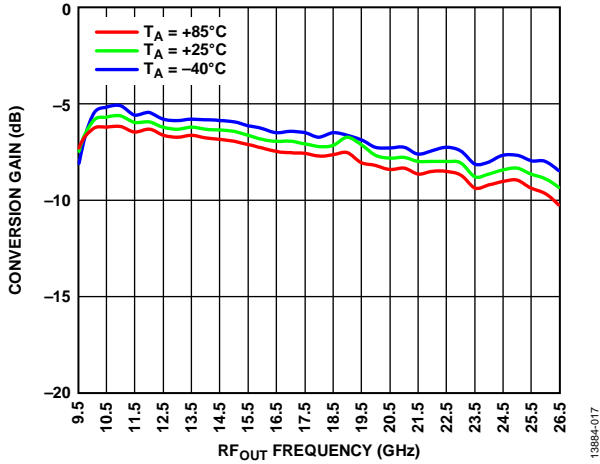

Figure 17. Conversion Gain vs. RF_{OUT} Frequency at Various Temperatures, LO = 13 dBm

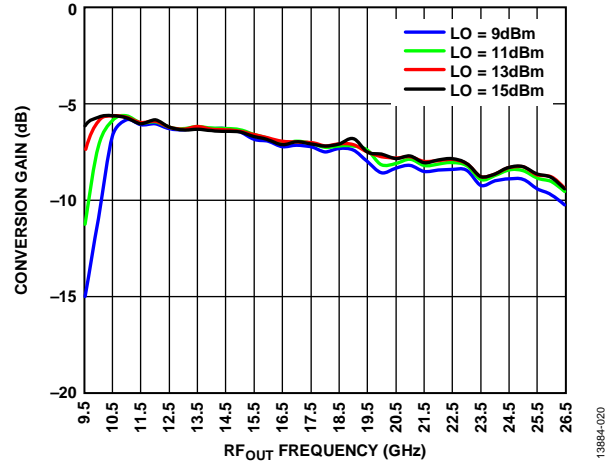

Figure 20. Conversion Gain vs. RF_{OUT} Frequency at Various LO Power Levels, $T_A = 25^\circ C$

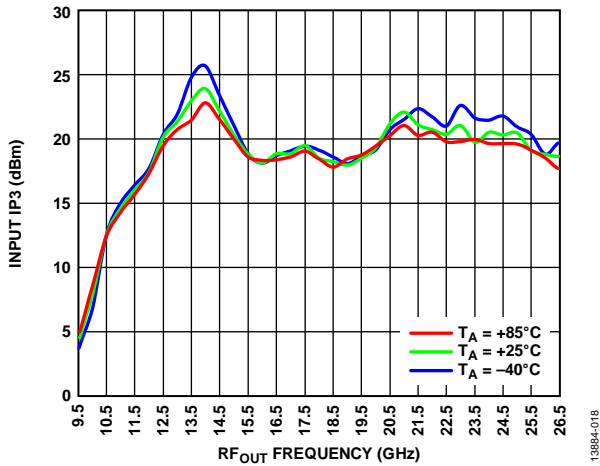

Figure 18. Input IP3 vs. RF_{OUT} Frequency at Various Temperatures, LO = 13 dBm

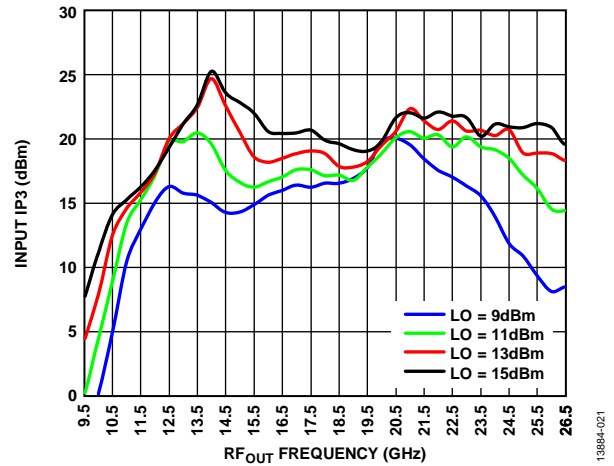

Figure 21. Input IP3 vs. RF_{OUT} Frequency at Various LO Power Levels, $T_A = 25^\circ C$

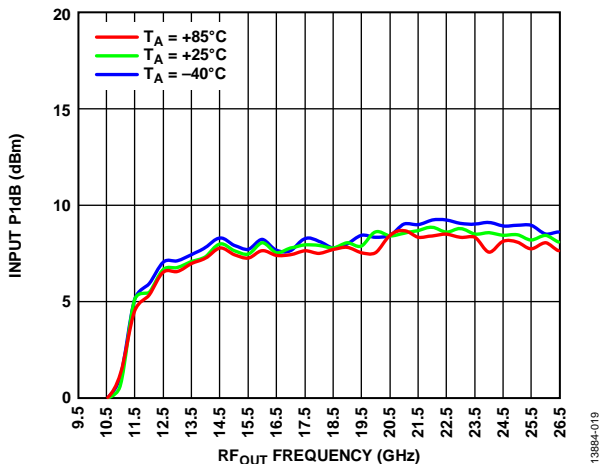

Figure 19. Input P1dB vs. RF_{OUT} Frequency at Various Temperatures, LO = 13 dBm

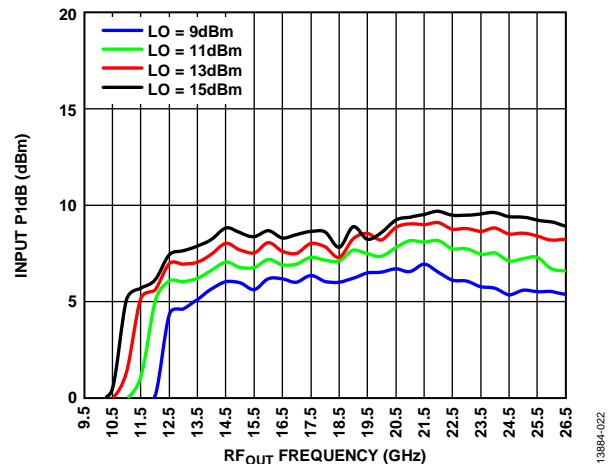

Figure 22. Input P1dB vs. RF_{OUT} Frequency at Various LO Power Levels, $T_A = 25^\circ C$

ISOLATION AND RETURN LOSS

Downconverter performance at IF = 1000 MHz, upper sideband.

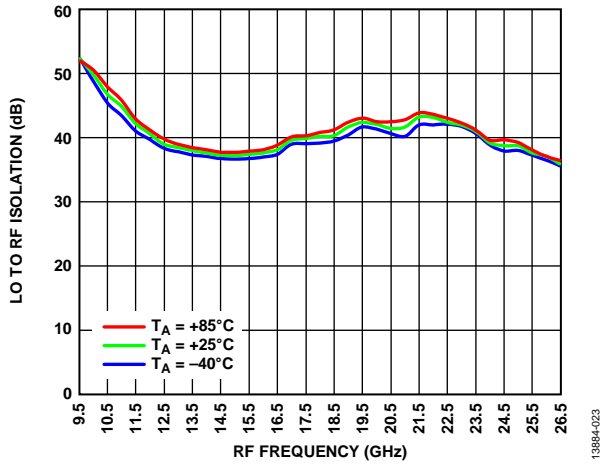

Figure 23. LO to RF Isolation vs. RF Frequency at Various Temperatures, LO = 13 dBm

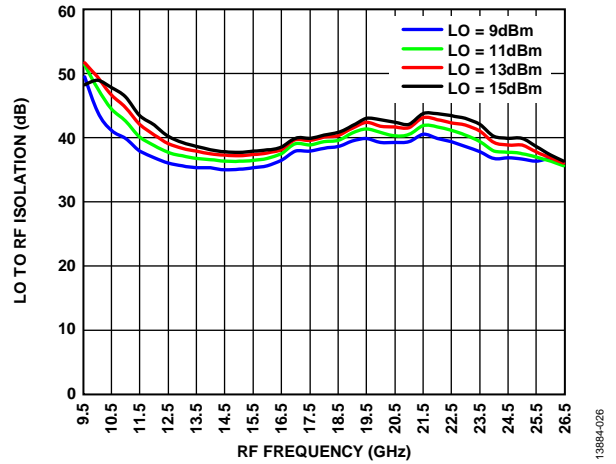

Figure 26. LO to RF Isolation vs. RF Frequency at Various LO Power Levels, TA = 25°C

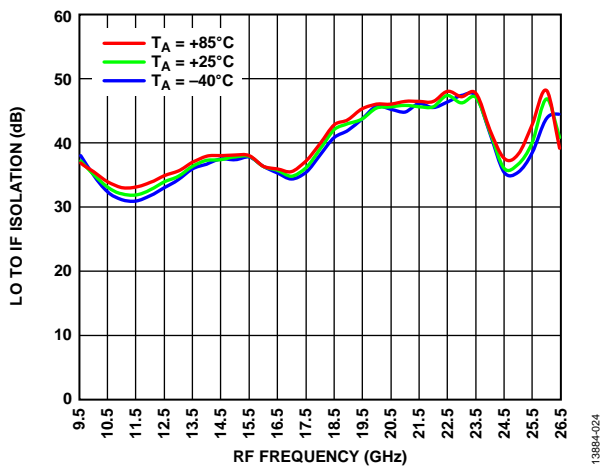

Figure 24. LO to IF Isolation vs. RF Frequency at Various Temperatures, LO = 13 dBm

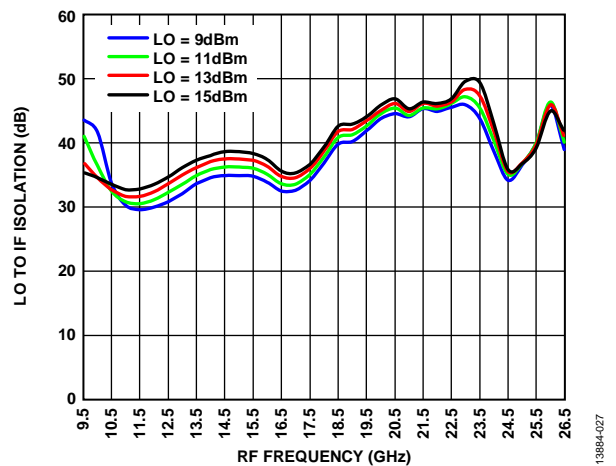

Figure 27. LO to IF Isolation vs. RF Frequency at Various LO Power Levels, TA = 25°C

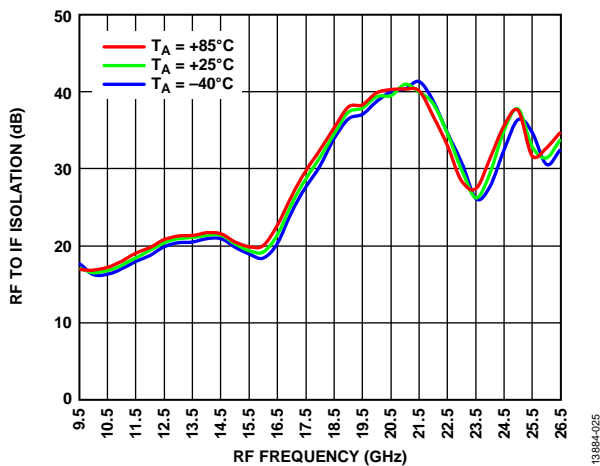

Figure 25. RF to IF Isolation vs. RF Frequency at Various Temperatures, LO = 13 dBm

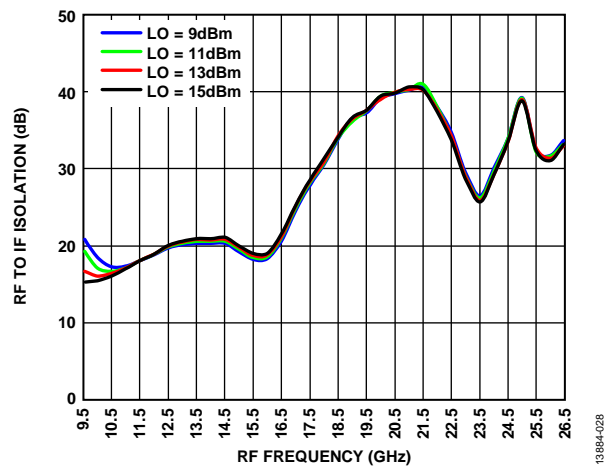

Figure 28. RF to IF Isolation vs. RF Frequency at Various LO Power Levels, LO = 17 GHz, TA = 25°C

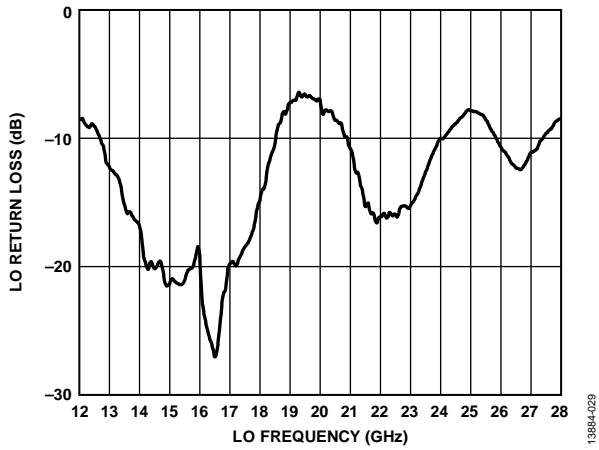

Figure 29. LO Return Loss vs. LO Frequency, $T_A = 25^\circ\text{C}$, LO = 13 dBm

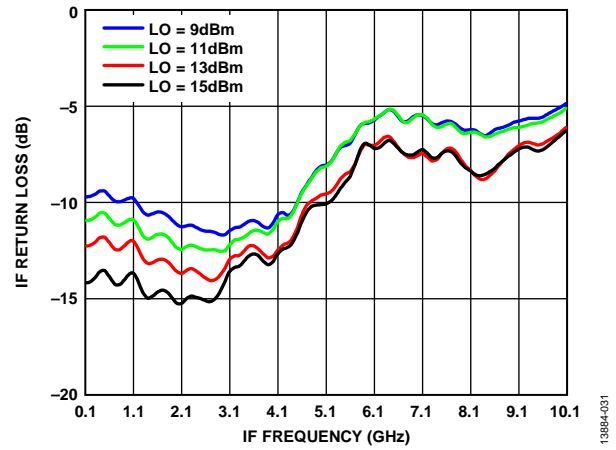

Figure 31. IF Return Loss vs. IF Frequency at Various LO Powers, LO = 17 GHz, $T_A = 25^\circ\text{C}$

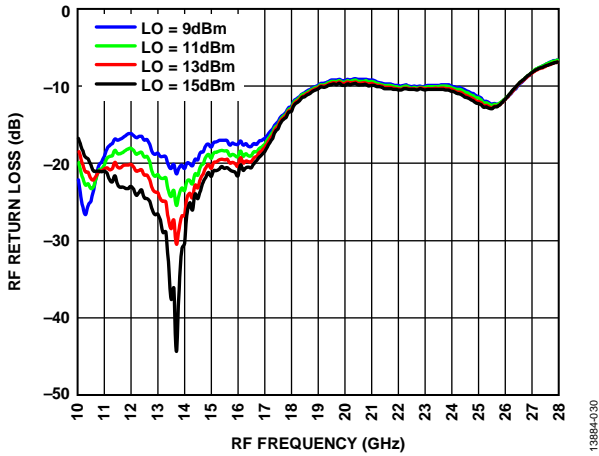

Figure 30. RF Return Loss vs. RF Frequency at Various LO Powers, $T_A = 25^\circ\text{C}$

IF BANDWIDTH—DOWNCONVERTER

Upper sideband, RF = 20 GHz.

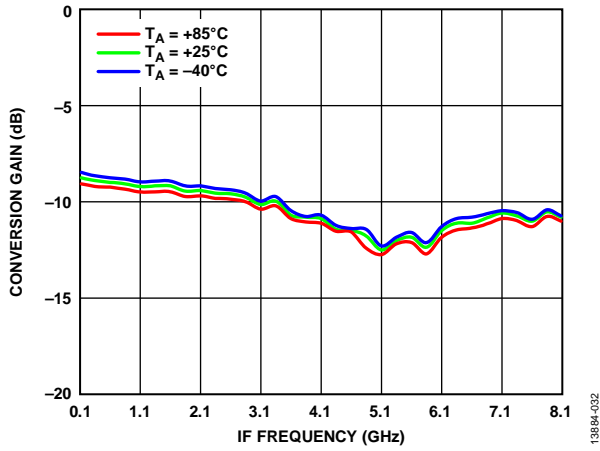

Figure 32. Conversion Gain vs. IF Frequency at Various Temperatures, LO = 13 dBm

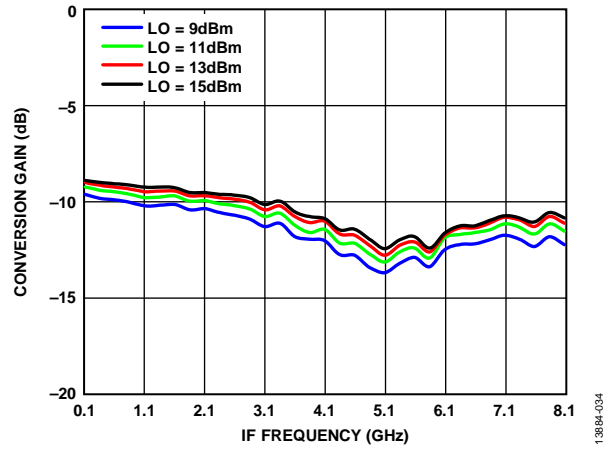

Figure 34. Conversion Gain vs. IF Frequency at Various LO Power Levels, $T_A = 25^\circ\text{C}$

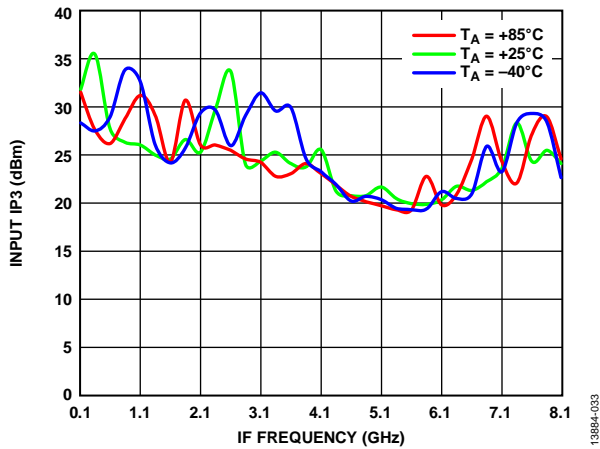

Figure 33. Input IP3 vs. IF Frequency at Various Temperatures, LO = 13 dBm

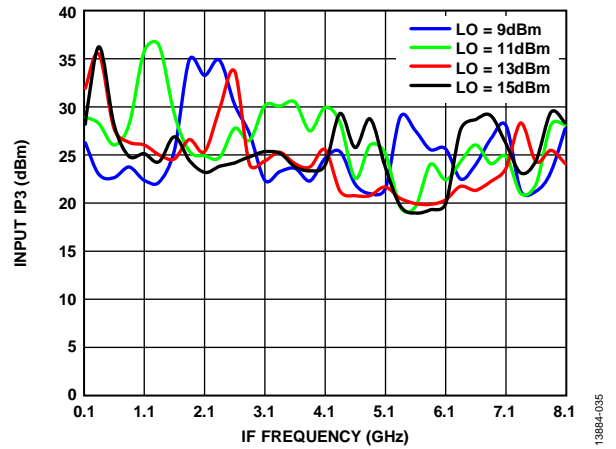

Figure 35. Input IP3 vs. IF Frequency at Various LO Power Levels, $T_A = 25^\circ\text{C}$

IF BANDWIDTH—UPCONVERTER

Upper sideband, RF_{OUT} = 20 GHz.

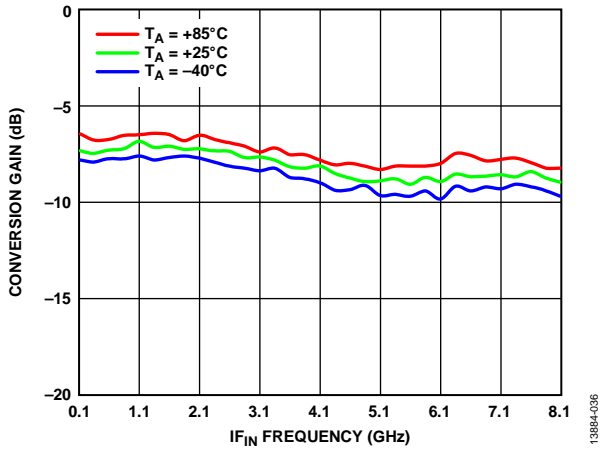

Figure 36. Conversion Gain vs. IF_{IN} Frequency at Various Temperatures, LO = 13 dBm

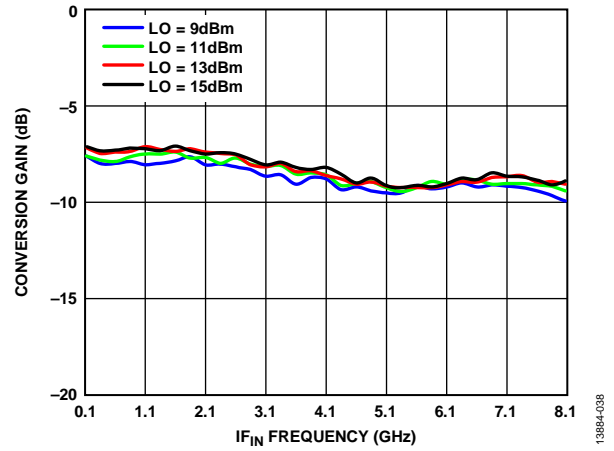

Figure 38. Conversion Gain vs. IF_{IN} Frequency at Various LO Power Levels, T_A = 25°C

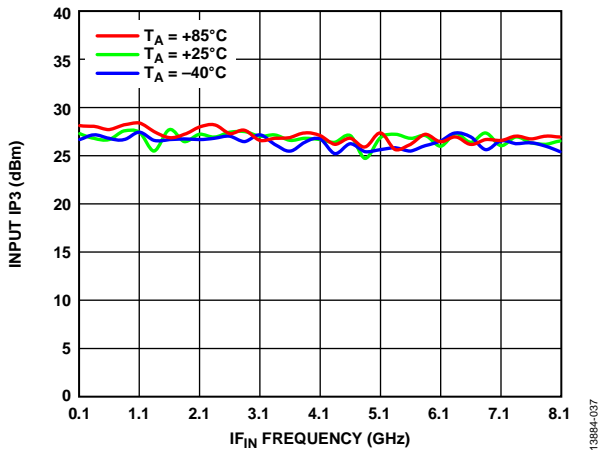

Figure 37. Input IP3 vs. IF_{IN} Frequency at Various Temperatures, LO = 13 dBm

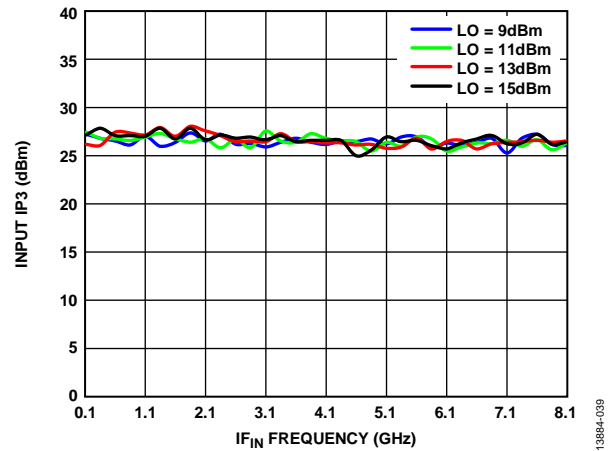

Figure 39. Input IP3 vs. IF_{IN} Frequency at Various LO Power Levels, T_A = 25°C

SPURIOUS AND HARMONICS PERFORMANCE

Mixer spurious products are measured in dBc from either the RF pin or IF pin output power level. N/A means not applicable.

Downconverter $M \times N$ Spurious Outputs

Spur values are $(M \times RF) - (N \times LO)$.

RF = 18 GHz at -10 dBm, LO = 17 GHz at 13 dBm.

		N x LO				
		0	1	2	3	4
M x RF	0	N/A	7	19	N/A	N/A
	1	23	0	34	42	N/A
	2	67	71	66	71	68
	3	N/A	63	72	84	73
	4	N/A	N/A	64	74	77

Upconverter $M \times N$ Spurious Outputs

Spur values are $(M \times IF_{IN}) + (N \times LO)$.

IF_{IN} = 1000 MHz at -10 dBm, LO = 17 GHz at 13 dBm.

		N x LO				
		0	1	2	3	4
M x IF _{IN}	-5	81	77	73	N/A	N/A
	-4	83	78	71	N/A	N/A
	-3	73	64	72	N/A	N/A
	-2	55	42	66	N/A	N/A
	-1	18	0	28	N/A	N/A
	0	0	9.5	17	N/A	N/A
	1	18	0	40	N/A	N/A
	2	55	45	67	N/A	N/A
	3	74	66	64	N/A	N/A
	4	81	74	66	N/A	N/A
	5	80	74	68	N/A	N/A

THEORY OF OPERATION

The HMC260ALC3B is a general-purpose, double balanced mixer that can be used as an upconverter or a downconverter from 10 GHz to 26 GHz.

When used as a downconverter, the HMC260ALC3B downconverts RF between 10 GHz and 26 GHz to IF between dc and 8 GHz.

When used as an upconverter, the mixer upconverts IF between dc and 8 GHz to RF between 10 GHz and 26 GHz.

The mixer performs well with LO drives of 9 dBm or greater, and it provides LO to RF and LO to IF suppression due to optimized balun structures. The ceramic LCC package eliminates the need for wire bonding and is compatible with high volume, surface-mount manufacturing techniques.

APPLICATIONS INFORMATION

TYPICAL APPLICATION CIRCUIT

Figure 40 shows the typical application circuit for the HMC260ALC3B. The HMC260ALC3B is a passive device and does not require any external components. The LO and RF pins are internally ac-coupled. The IF pin is internally dc-coupled. When IF operation to dc is not required, use of an external series capacitor of a value chosen to pass the necessary IF frequency range is recommended. When IF operation to dc is required, do not exceed the IF source and sink current rating specified in the Absolute Maximum Ratings section.

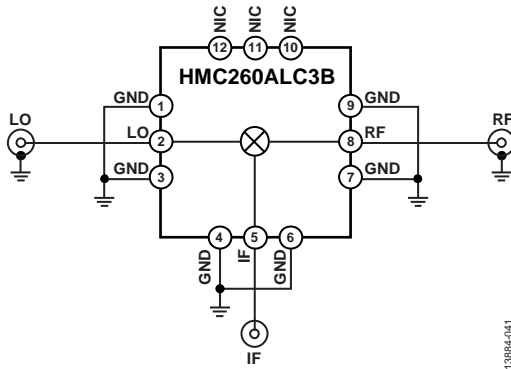

Figure 40. Typical Application Circuit

EVALUATION PCB INFORMATION

Use RF circuit design techniques for the circuit board. Ensure that signal lines have 50 Ω impedance. Connect the package ground leads and the exposed pad directly to the ground plane (see Figure 41). Use a sufficient number of via holes to connect the top and bottom ground planes. The evaluation circuit board shown in Figure 41 is available from Analog Devices, Inc., upon request.

Table 5. Bill of Materials

Item	Description
J1, J2	PCB mount SRI 2.92 mm connectors
J3	PCB mount Johnson SMA connector
U1	HMC260ALC3B
PCB ¹	117611 evaluation board on Rogers 4350

¹ 117611 is the raw bare PCB identifier. Reference 109728 when ordering the complete evaluation PCB.

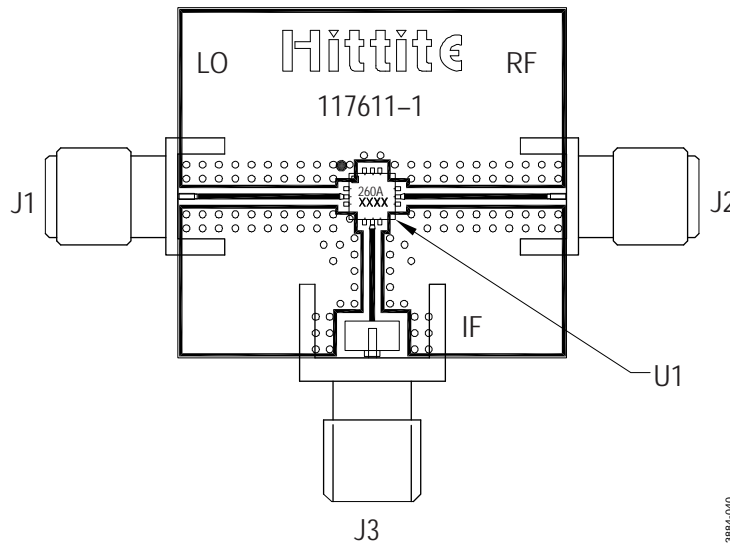

Figure 41. Evaluation PCB Top Layer