

**0.5 dB LSB GaAs MMIC 6-BIT DIGITAL
POSITIVE CONTROL ATTENUATOR, 2.2 - 8.0 GHz**

Typical Applications

The HMC425ALP3E is ideal for:

- WLAN & Point-to-Multi-Point
- Fiber Optics & Broadband Telecom
- Microwave Radio & VSAT
- Military

Features

- 0.5 dB LSB Steps to 31.5 dB
- Single Control Line Per Bit
- ± 0.5 dB Typical Bit Error
- Single +5V Supply
- 3x3 mm SMT Package

Functional Diagram

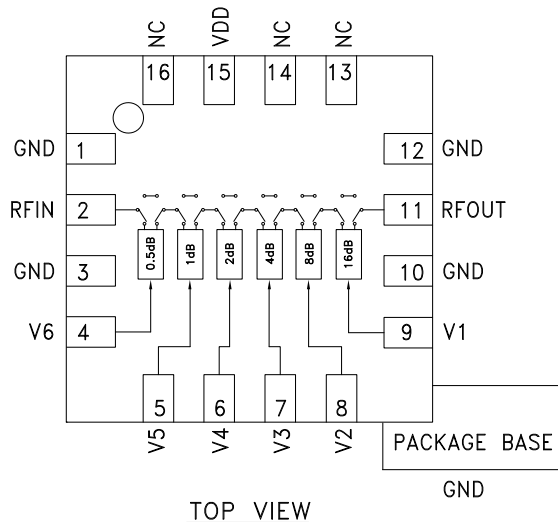

TOP VIEW

General Description

HMC425ALP3E are broadband 6-bit GaAs IC digital attenuators in low cost leadless surface mount packages. Covering 2.2 GHz to 8.0 GHz, the insertion loss is less than 4.5 dB typical. The attenuator bit values are 0.5 (LSB), 1, 2, 4, 8, and 16 dB for a total attenuation of 31.5 dB. Attenuation accuracy is excellent at ± 0.5 dB typical step error with an IIP3 of +40 dBm. Six control voltage inputs, toggled between 0 and +3 to +5V, are used to select each attenuation state. A single VDD bias of +3 to +5V is required.

Electrical Specifications

$T_A = +25^\circ C$, With $VDD = +5V$ & $VCTL = 0/+5V$ (Unless Otherwise Noted)

Parameter	Frequency	Min.	Typ.	Max.	Units
Insertion Loss	2.2 - 6.0 GHz 6.0 - 8.0 GHz		3.5 4.5	4 4.7	dB dB
Attenuation Range	2.2 - 8.0 GHz		31.5		dB
Return Loss (RF1 & RF2, All Atten. States)	2.2 - 8.0 GHz		15		dB
Attenuation Accuracy (Referenced to Insertion Loss)	All States 2.2 - 8.0 GHz	± (0.5 + 5% of Atten. Setting Max.)			dB
Input Power for 0.1 dB Compression	VDD= 5V VDD = 3V 2.2 - 8.0 GHz		25 23		dBm dBm
Input Third Order Intercept Point (Two-Tone Input Power= 0 dBm Each Tone)	REF - 16.0 dB States 16.5 - 31.5 dB States 2.2 - 8.0 GHz		45 40		dBm dBm
Switching Characteristics	2.2 - 8.0 GHz		400 420		ns ns
t_{RISE}, t_{FALL} (10/90% RF) t_{ON}, t_{OFF} (50% CTL to 10/90% RF)					

**0.5 dB LSB GaAs MMIC 6-BIT DIGITAL
POSITIVE CONTROL ATTENUATOR, 2.2 - 8.0 GHz**

Insertion Loss

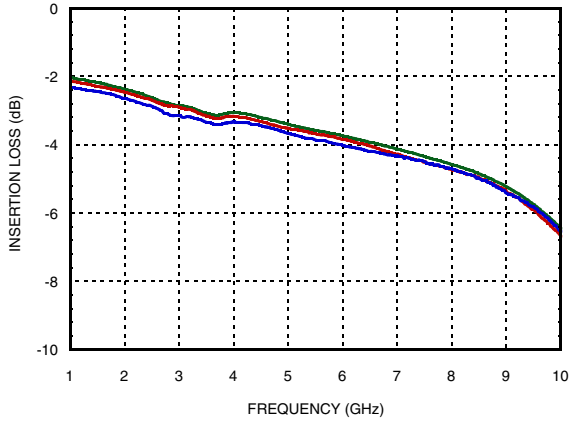

**Return Loss RF1, RF2
(Only Major States are Shown)**

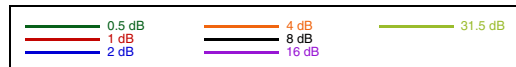
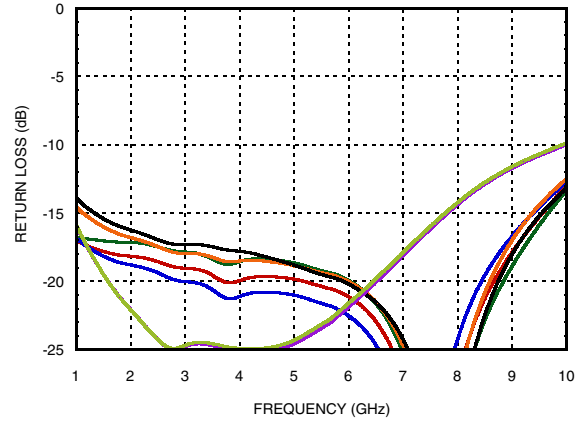

**Normalized Attenuation
(Only Major States are Shown)**

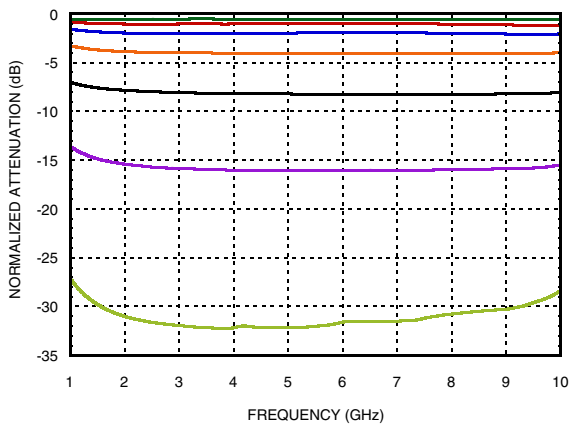

Bit Error vs. Attenuation State

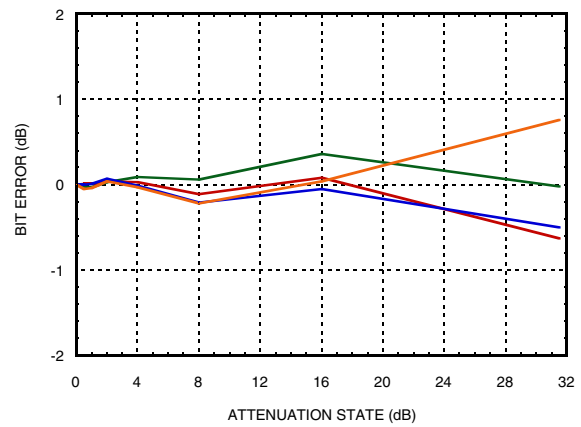

**Bit Error vs. Frequency
(Only Major States are Shown)**

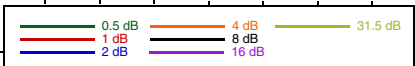
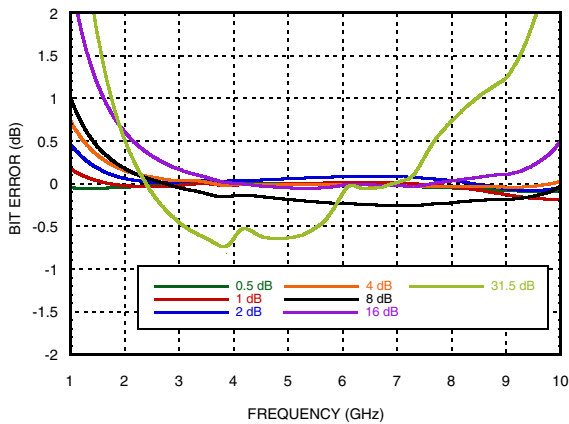

**Relative Phase vs. Frequency
(Only Major States are Shown)**

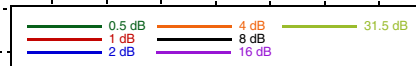
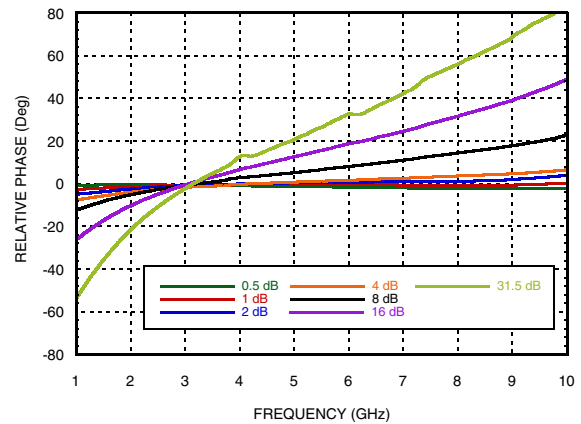

0.5 dB LSB GaAs MMIC 6-BIT DIGITAL POSITIVE CONTROL ATTENUATOR, 2.2 - 8.0 GHz

Worst Case Step Error Between Successive Attenuation States

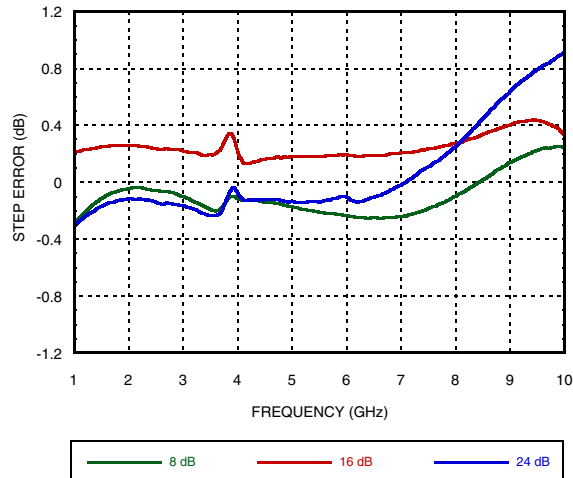

P0.1dB vs. Temperature, IL State

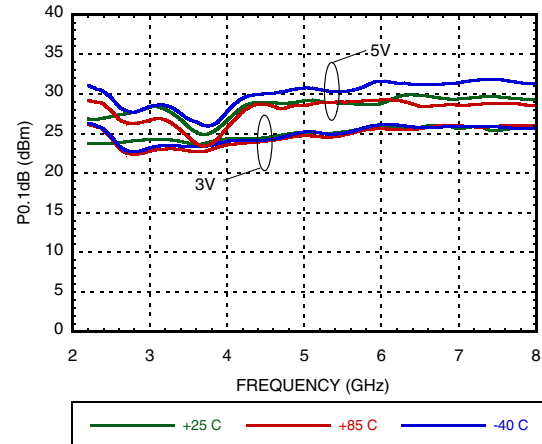

IIP3 vs. Frequency at VDD=3V

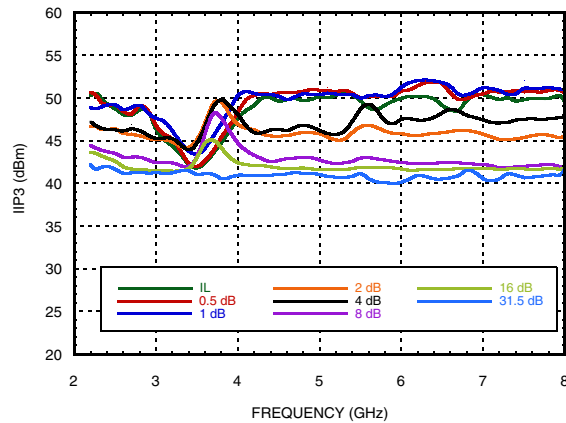

IIP3 vs. Frequency at VDD=5V

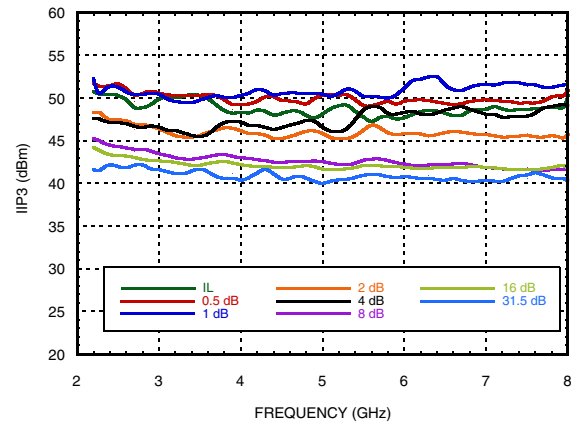

Truth Table

Control Voltage Input						Attenuation State RF1 - RF2
V1 16 dB	V2 8 dB	V3 4 dB	V4 2 dB	V5 1 dB	V6 0.5 dB	
High	High	High	High	High	High	Reference I.L.
High	High	High	High	High	Low	0.5 dB
High	High	High	High	Low	High	1 dB
High	High	High	Low	High	High	2 dB
High	High	Low	High	High	High	4 dB
High	Low	High	High	High	High	8 dB
Low	High	High	High	High	High	16 dB
Low	Low	Low	Low	Low	Low	31.5 dB

Any combination of the above states will provide an attenuation approximately equal to the sum of the bits selected.

Bias Voltage & Current

VDD Range = +3.0 V to +5.0 V	
VDD (Vdc)	IDD (Typ.)
+3.0 V	10 μ A
+5.0 V	30 μ A

Control Voltage

State	Bias Condition
Low	0 to 0.2V at 10 μ A Typ.
High	VDD \pm 0.2V at 5 μ A Typ.

Note: VDD = +3V to +5V

0.5 dB LSB GaAs MMIC 6-BIT DIGITAL POSITIVE CONTROL ATTENUATOR, 2.2 - 8.0 GHz

Absolute Maximum Ratings

Control Voltage (V1 to V6)	VDD +0.5 Vdc
Supply Voltage (VDD)	+7.0 Vdc
Storage Temperature	-65 to +150 °C
Operating Temperature	-40 to +85 °C
RF Input Power (2.2 - 8.0 GHz)	+27 dBm
ESD Sensitivity (HBM)	Class 1A
ESD Sensitivity (FICDM)	Class IV



ELECTROSTATIC SENSITIVE DEVICE
OBSERVE HANDLING PRECAUTIONS

Outline Drawing



16-Lead Lead Frame Chip Scale Package [LFCSP]
3 x 3 mm Body and 0.85 mm Package Height
(CP-16-50)
Dimensions shown in millimeters

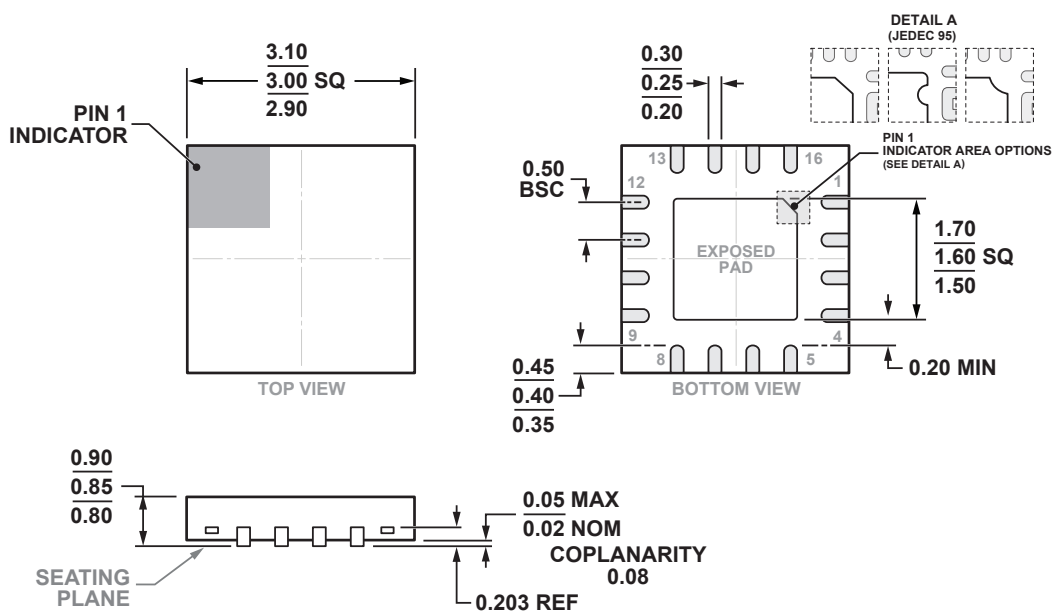

COMPLIANT TO JEDEC STANDARDS MO-220-VEED-4

Package Information

Part Number	Package Body Material	Lead Finish	MSL Rating	Package Marking ^[2]
HMC425ALP3E	RoHS-compliant Low Stress Injection Molded Plastic	100% Matte Sn	MSL3 ^[1]	H425A XXXX

[1] Max peak reflow temperature of 260 °C

[2] 4-Digit lot number XXXX

**0.5 dB LSB GaAs MMIC 6-BIT DIGITAL
POSITIVE CONTROL ATTENUATOR, 2.2 - 8.0 GHz**

Pin Descriptions

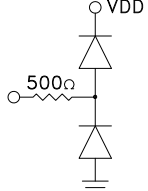
Pin Number	Function	Description	Interface Schematic
1, 3, 10, 12	GND	Package bottom has an exposed metal paddle that must also be connected to RF ground.	
2, 11	RFIN, RFOUT	This pin is DC coupled and matched to 50 Ohm. Blocking capacitors are required.	
4, 5, 6, 7, 8, 9	V1 - V6	See truth table and control voltage table.	
13, 14, 16	NC	This pin should be connected to PCB RF ground to maximize performance.	
15	VDD	Supply Voltage	

Evaluation PCB Schematic

