



GaAs MMIC SP4T NON-REFLECTIVE SWITCH, DC - 20 GHz

Typical Applications

The HMC641ALC4 is ideal for:

- Telecom Infrastructure
- Microwave Radio & VSAT
- Military & Space Hybrids
- Test Instrumentation
- SATCOM & Sensors

Features

- Broadband Performance: DC - 20 GHz
- High Isolation: 42 dB @ 12 GHz
- Low Insertion Loss: 2.1 dB @ 12 GHz
- Integrated 2:4 TTL Decoder
- 24 Lead 4x4mm SMT Package: 16mm²

Functional Diagram

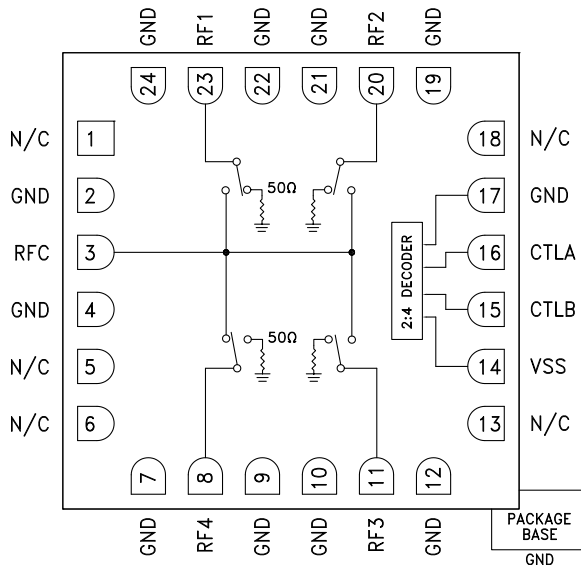

General Description

The HMC641ALC4 is a broadband non-reflective GaAs pHEMT SP4T switch in a compact 4x4 mm ceramic package. Covering DC to 20 GHz, this switch offers high isolation, low insertion loss and on-chip termination of isolated ports. This switch also includes an on board binary decoder circuit which reduces the number of required logic control lines from four to two. The HMC641ALC4 is controlled with 0/ -5V logic, exhibits fast switching speed and consumes much less DC current than pin diode based solutions.

Electrical Specifications, $T_A = +25^\circ C$, With 0/-5V Control, $V_{SS} = -5V$, 50 Ohm System

Parameter	Frequency	Min.	Typ.	Max.	Units
Insertion Loss	DC - 12 GHz		1.8	2.8	dB
	DC - 20 GHz		2.3	3.5	dB
Isolation (RFC to RF1 - RF4)	DC - 12 GHz	30	42		dB
	DC - 20 GHz	30	40		dB
Return Loss	"On State"	DC - 12 GHz	18		dB
		DC - 20 GHz	17		dB
Return Loss	"Off State"	DC - 20 GHz	19		dB
Input Power for 1 dB Compression	0.05 - 0.25 GHz	10	15		dBm
	0.25 - 20 GHz	20	25		dBm
Input Third Order Intercept (Two-Tone Input Power= +10 dBm Each Tone)	0.05 - 0.25 GHz		32		dBm
	0.25 - 20 GHz		41		dBm
Switching Characteristics	DC - 20 GHz	tRISE, tFALL (10/90% RF)	30		ns
		tON, tOFF (50% CTL to 10/90% RF)	100		ns



GaAs MMIC SP4T NON-REFLECTIVE SWITCH, DC - 20 GHz

Insertion Loss vs. Temperature

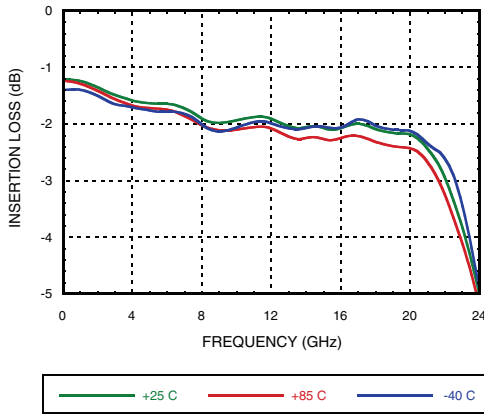

Isolation

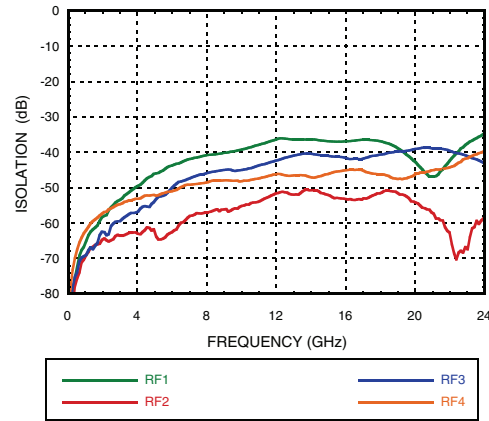

Return Loss

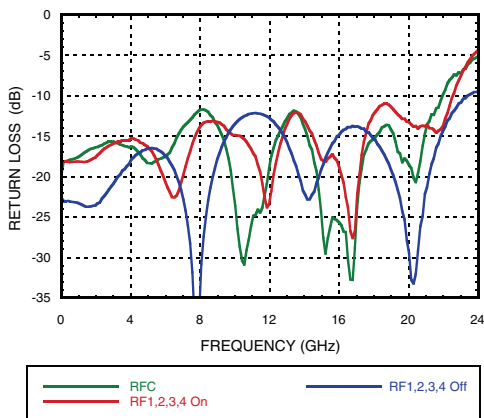

1 dB Input Compression Point

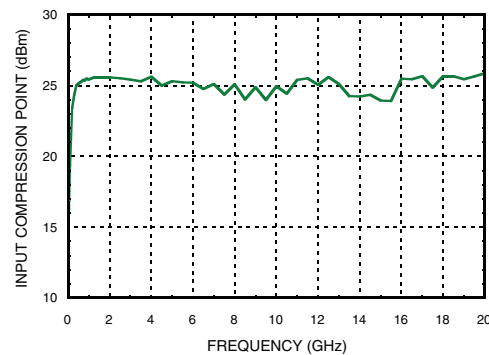

Input Third Order Intercept Point @ 10 dBm Tone Power

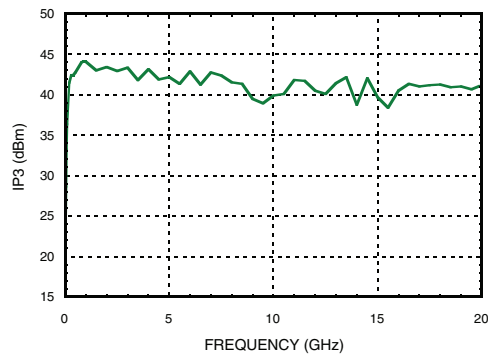

**GaAs MMIC SP4T NON-REFLECTIVE
SWITCH, DC - 20 GHz**
Absolute Maximum Ratings

Bias Voltage (Vss)	-7V
Control Voltage Range (A & B)	Vss -0.5V to +1V
Maximum Input Power	
Insertion Loss Path	+26.5 dBm
Terminated Path	+23 dBm
Channel Temperature	150 °C
Thermal Resistance	
Channel to die bottom	
Insertion Loss Path	201 °C/W
Terminated Path	321 °C/W
Storage Temperature	-65 to +150 °C
Operating Temperature	-40 to +85 °C



**ELECTROSTATIC SENSITIVE DEVICE
OBSERVE HANDLING PRECAUTIONS**

Truth Table

Control Input		Signal Path State
A	B	RFC to:
High	High	RF1
Low	High	RF2
High	Low	RF3
Low	Low	RF4

Bias Voltage & Current

Vss Range= -5.0 Vdc ±10%		
Vss (Vdc)	Iss (Typ) (mA)	Iss (Max) (mA)
-5	1.8	5.0

TTL/CMOS Control Voltages

State	Bias Condition
Low	-2.5V to 0V @ 30 µA Typ.
High	-5V to -3.8V @ 0.5 µA Typ.

GaAs MMIC SP4T NON-REFLECTIVE SWITCH, DC - 20 GHz



Outline Drawing

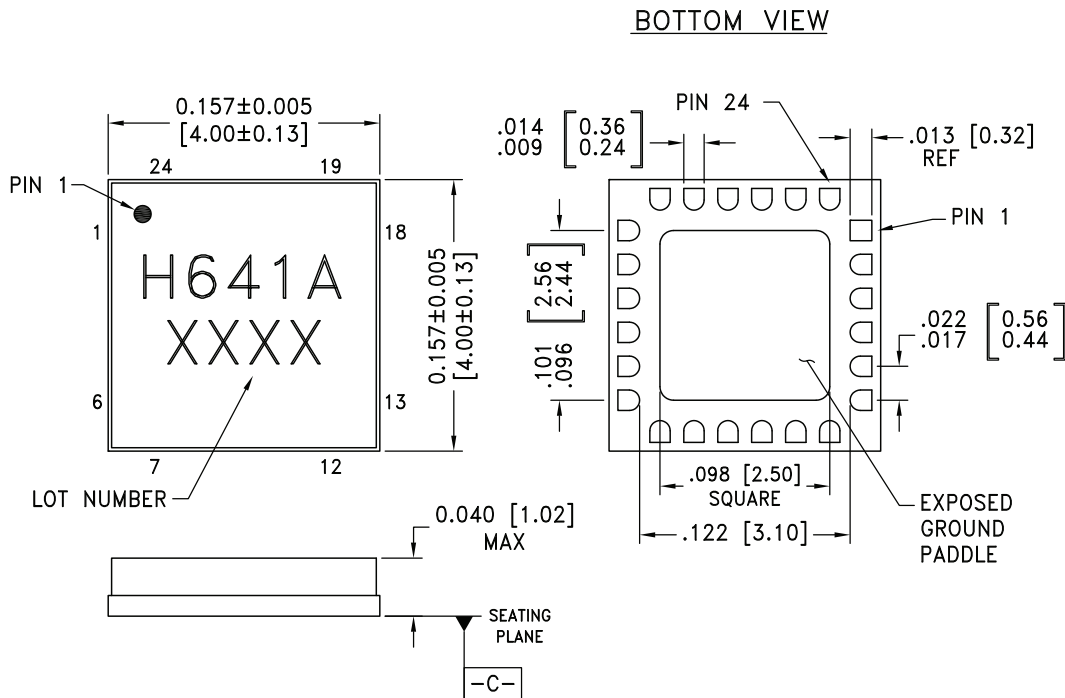

NOTES:

1. PACKAGE BODY MATERIAL: ALUMINA
2. LEAD AND GROUND PADDLE PLATING: 30-80 MICROINCHES GOLD OVER 50 MICROINCHES MINIMUM NICKEL.
3. DIMENSIONS ARE IN INCHES [MILLIMETERS].
4. LEAD SPACING TOLERANCE IS NON-CUMULATIVE
5. PACKAGE WARP SHALL NOT EXCEED 0.05mm DATUM **-C-**
6. ALL GROUND LEADS AND GROUND PADDLE MUST BE SOLDERED TO PCB RF GROUND.

Package Information

Part Number	Package Body Material	Lead Finish	MSL Rating	Package Marking ^[2]
HMC641ALC4	Alumina, White	Gold over Nickel	MSL3 ^[1]	H641A XXXX

[1] Max peak reflow temperature of 260 °C

[2] 4-Digit lot number XXXX

**GaAs MMIC SP4T NON-REFLECTIVE
SWITCH, DC - 20 GHz**
Pin Descriptions

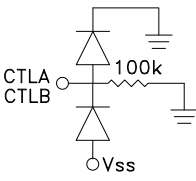
Pin Number	Function	Description	Interface Schematic
1, 5, 6, 13, 18	N/C	These pins are not connected internally; however, all data shown herein was measured with these pins connected to RF/DC ground externally.	
2, 4, 7, 9, 10, 12, 17, 19, 21, 22, 24 Ground Paddle	GND	These pins and the exposed ground paddle must be connected to RF/DC ground.	
3, 8, 11, 20, 23	RFC, RF1, RF2, RF3, RF4	These pads are DC coupled and matched to 50 Ohms. Blocking capacitors are required if RF line potential is not equal to 0V.	
14	Vss	Supply Voltage -5 Vdc ± 10%.	
15	CTLB	See Truth Table and Control Voltage Table.	
16	CTLA	See Truth Table and Control Voltage Table.	