

FEATURES

Amplitude settling time: 200 ns
Excellent wideband rejection: ≥ 30 dB
Single-chip replacement for mechanically tuned designs
32-lead, 5 mm \times 5 mm, RoHS compliant LFCSP package

APPLICATIONS

Test and measurement equipment
Military radar and electronic warfare (EW)/electronic countermeasures (ECM)
Satellite communications (SATCOM) and space
Industrial and medical equipment

GENERAL DESCRIPTION

The HMC892ALP5E is a tunable band-pass filter that features a user selectable pass-band frequency. The 3 dB filter bandwidth is approximately 8.7%. The 20 dB filter bandwidth is approximately 23.8%. The center frequency can be varied between 3.45 GHz and 6.25 GHz by applying an analog tuning voltage between 0 V and 14 V.

FUNCTIONAL BLOCK DIAGRAM

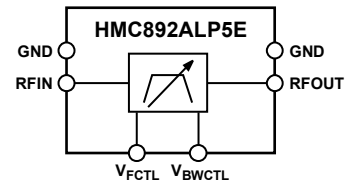

Figure 1.

16983-001

This tunable filter can be used as a smaller alternative to physically large switched filter banks and cavity tuned filters.

The HMC892ALP5E has excellent microphonics due to the monolithic design and provides a dynamically adjustable solution in advanced communications applications.

TABLE OF CONTENTS

Features	1	Typical Performance Characteristics	6
Applications.....	1	Theory of Operation	9
Functional Block Diagram	1	Applications Information	10
General Description	1	Typical Application Circuit.....	10
Revision History	2	Evaluation PCB Information	10
Specifications.....	3	Outline Dimensions	11
Absolute Maximum Ratings.....	4	Ordering Guide.....	11
ESD Caution.....	4		
Pin Configuration and Function Descriptions.....	5		

REVISION HISTORY

9/2018—Revision 0: Initial Version

SPECIFICATIONS

$T_A = 25^\circ\text{C}$, $V_{\text{FCTL}} = V_{\text{BWCTL}}$, unless otherwise noted.

Table 1.

Parameter	Min	Typ	Max	Unit	Test Conditions/Comments
FREQUENCY RANGE Center (f_{CENTER})	3.45		6.25	GHz	
BANDWIDTH 3 dB 3 dB Bandwidth Control, V_{BWCTL}		8.7 3		% %	Percent change of bandwidth over f_{CENTER} , as V_{BWCTL} changes
REJECTION Low-Side High-Side Re-Entry		$0.89 \times f_{\text{CENTER}}$ $1.13 \times f_{\text{CENTER}}$ $5.70 \times f_{\text{CENTER}}$		GHz GHz GHz	≥ 20 dB ≥ 20 dB ≤ 30 dB
LOSS Insertion Return		9.5 9.6		dB dB	
DYNAMIC PERFORMANCE Maximum Input Power for Linear Operation Input Third-Order Intercept (IP3) Group Delay Phase Sensitivity Amplitude Settling Drift Rate			10	dBm dBm ns Radian/V ns MHz/ $^\circ\text{C}$	Input power (P_{IN}) = 20 dBm per tone Time to settle to minimum insertion loss, within ≤ 0.5 dB of static insertion loss
RESIDUAL PHASE NOISE 1 MHz Offset		-165		dBc/Hz	
TUNING Voltages (V_{FCTL} , V_{BWCTL}) Currents (I_{FCTL} , I_{BWCTL})	0		14 ± 1	V μA	Each pin can be driven independently Rated current for each pin

ABSOLUTE MAXIMUM RATINGS

Table 2.

Parameter	Rating
Tuning	
Voltages (V_{FCTL} , V_{BWCTL})	-0.5 V to +15 V
Currents (I_{FCTL} , I_{BWCTL})	± 1 mA
RF Input Power	27 dBm
Temperature	
Operating	-40°C to +85°C
Storage	-65°C to +150°C
Junction for 1,000,000 Mean Time to Failure (MTTF)	175°C
Nominal Junction (Paddle Temperature (T_{PADDLE}) = 85°C, P_{IN} = 10 dBm)	90°C
Electrostatic Discharge (ESD) Sensitivity Rating	
Human Body Model (HBM)	1500 V
Field Induced Charged Device Model (FICDM)	1250 V
Moisture Sensitivity Level (MSL) Rating	MSL3

Stresses at or above those listed under Absolute Maximum Ratings may cause permanent damage to the product. This is a stress rating only; functional operation of the product at these or any other conditions above those indicated in the operational section of this specification is not implied. Operation beyond the maximum operating conditions for extended periods may affect product reliability.

ESD CAUTION



ESD (electrostatic discharge) sensitive device. Charged devices and circuit boards can discharge without detection. Although this product features patented or proprietary protection circuitry, damage may occur on devices subjected to high energy ESD. Therefore, proper ESD precautions should be taken to avoid performance degradation or loss of functionality.

PIN CONFIGURATION AND FUNCTION DESCRIPTIONS

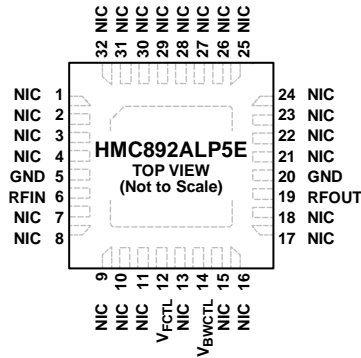

- NOTES**
1. NIC = NOT INTERNALLY CONNECTED. THESE PINS ARE NOT CONNECTED INTERNALLY. ALL DATA SHOW IN THIS DATA SHEET WAS MEASURED WITH THESE PINS CONNECTED TO RF OR DC GROUND EXTERNALLY.
 2. EXPOSED PAD. THE PACKAGE BOTTOM HAS AN EXPOSED METAL PAD THAT MUST BE CONNECTED TO RF AND DC GROUND.

Figure 2. Pin Configuration

Table 3. Pin Function Descriptions

Pin No.	Mnemonic	Description
1 to 4, 7 to 11, 13, 15 to 18, 21 to 32	NIC	Not Internally Connected. These pins are not connected internally. All data shown in this data sheet was measured with these pins connected to RF or dc ground externally.
5, 20	GND	Ground. These pins and exposed paddle must be connected to RF or dc ground. See Figure 5 for the interface schematic.
6	RFIN	Radio Frequency Input. This pin is dc-coupled and is matched to 50 Ω. Do not apply external voltage to this pin. See Figure 3 for the interface schematic.
12	V _{FCTL}	Center Frequency Control Voltage. See Figure 4 for the interface schematic.
14	V _{BWCTL}	Bandwidth Control Voltage. See Figure 7 for the interface schematic.
19	RFOUT	Radio Frequency Output. This pin is dc-coupled and is matched to 50 Ω. Do not apply external voltage to this pin. See Figure 6 for the interface schematic.
	EPAD	Exposed Pad. The package bottom has an exposed metal pad that must be connected to RF and dc ground.

INTERFACE SCHEMATICS

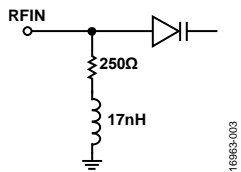

Figure 3. RFIN Interface Schematic

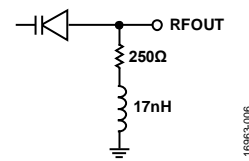

Figure 6. RFOUT Interface Schematic



Figure 4. V_{FCTL} Interface Schematic

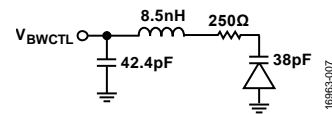

Figure 7. V_{BWCTL} Interface Schematic



Figure 5. GND Interface Schematic

TYPICAL PERFORMANCE CHARACTERISTICS

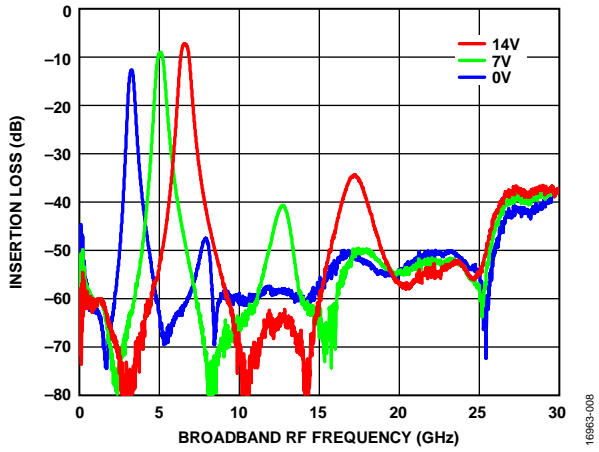

Figure 8. Insertion Loss vs. Broadband RF Frequency at Various Voltages, $V_{FCTL} = V_{BWCTL}$

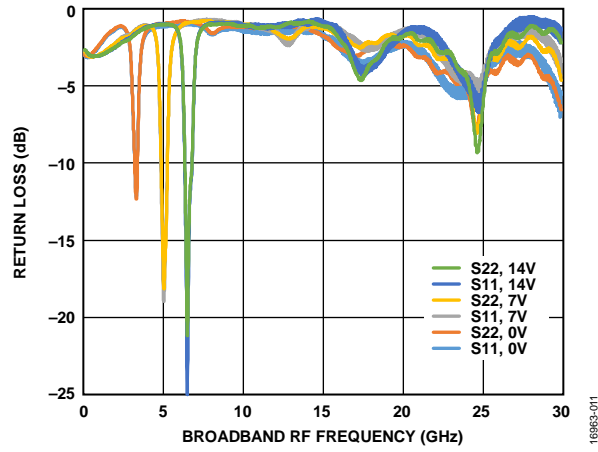

Figure 11. Return Loss (S11 and S22) vs. Broadband RF Frequency at Various Voltages, $V_{FCTL} = V_{BWCTL}$

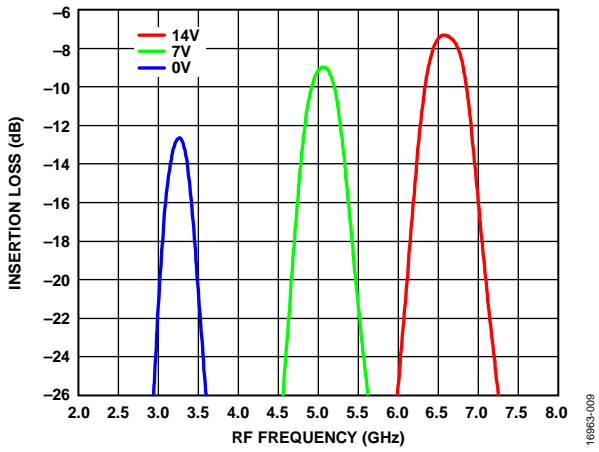

Figure 9. Insertion Loss vs. RF Frequency at Various Voltages, $V_{FCTL} = V_{BWCTL}$

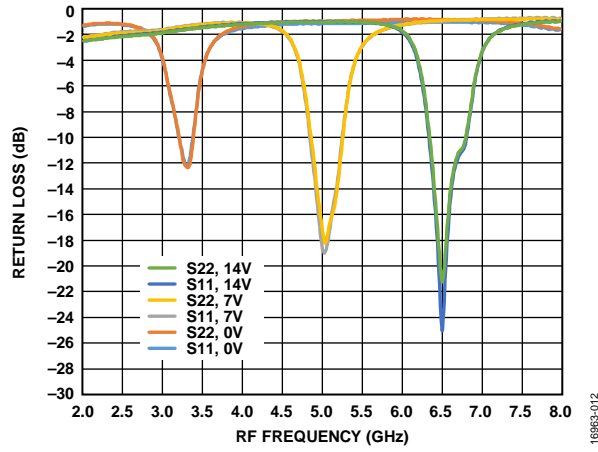

Figure 12. Return Loss vs. RF Frequency at Various Voltages, $V_{FCTL} = V_{BWCTL}$

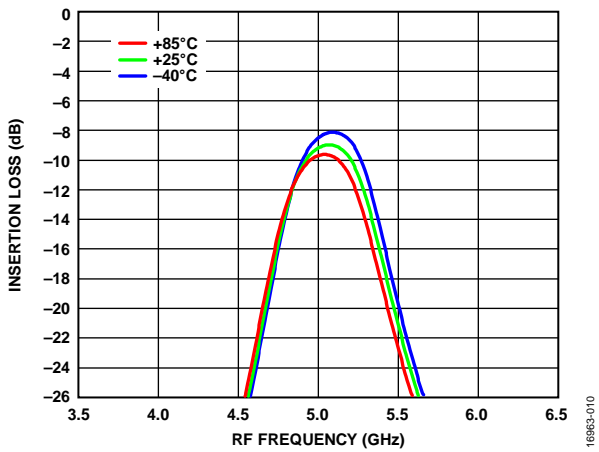

Figure 10. Insertion Loss vs. RF Frequency at Various Temperatures, $V_{FCTL} = V_{BWCTL} = 7V$

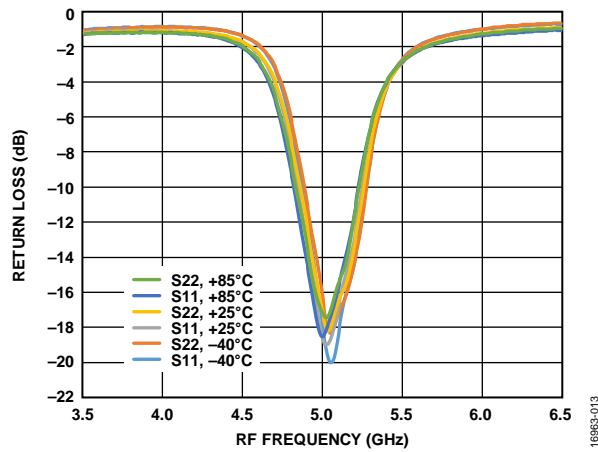

Figure 13. Return Loss vs. RF Frequency at Various Temperatures, $V_{FCTL} = V_{BWCTL} = 7V$

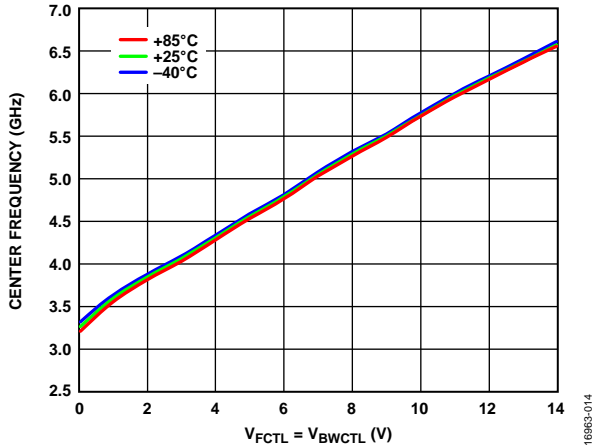

Figure 14. Center Frequency vs. $V_{FCTL} = V_{BWCTL}$ at Various Temperatures

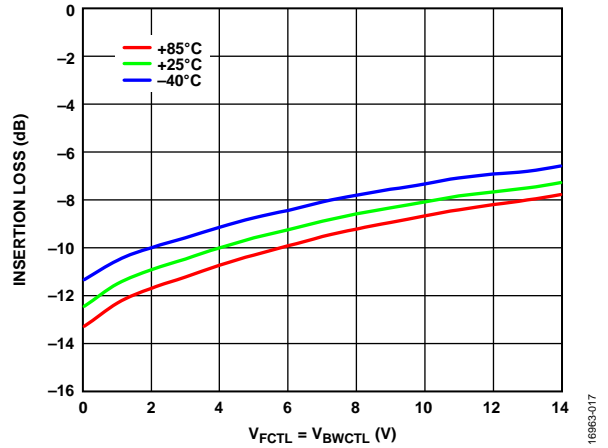

Figure 17. Insertion Loss vs. $V_{FCTL} = V_{BWCTL}$ at Various Temperatures

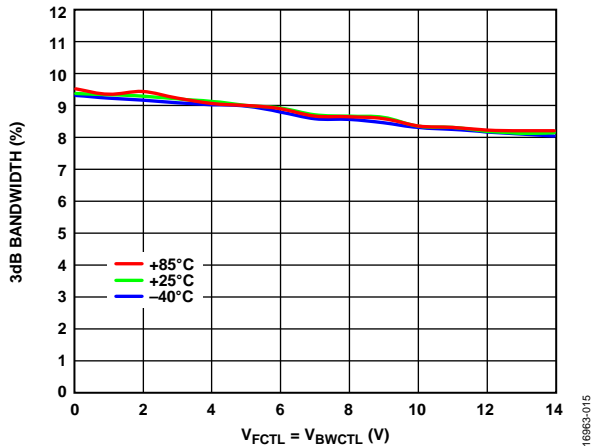

Figure 15. 3 dB Bandwidth vs. $V_{FCTL} = V_{BWCTL}$ at Various Temperatures

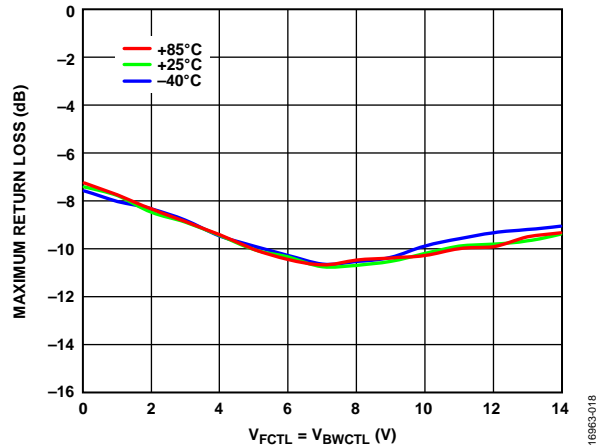

Figure 18. Maximum Return Loss vs. $V_{FCTL} = V_{BWCTL}$ at Various Temperatures, 2 dB Bandwidth

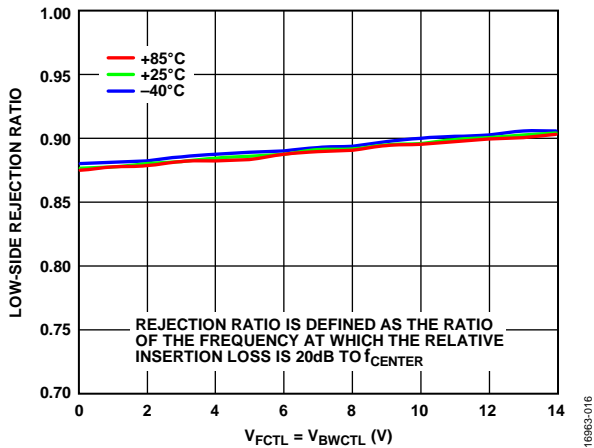

Figure 16. Low-Side Rejection Ratio vs. $V_{FCTL} = V_{BWCTL}$ at Various Temperatures

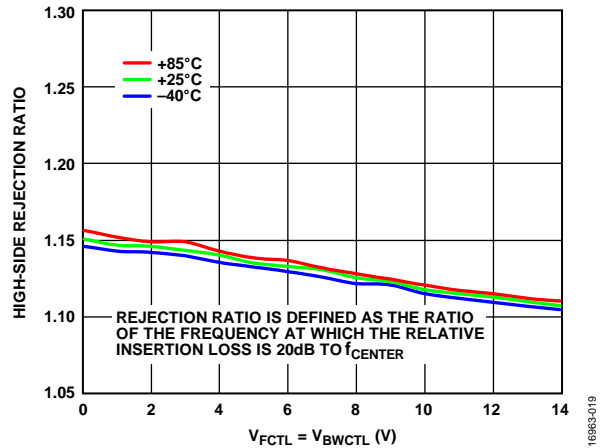

Figure 19. High-Side Rejection Ratio vs. $V_{FCTL} = V_{BWCTL}$ at Various Temperatures

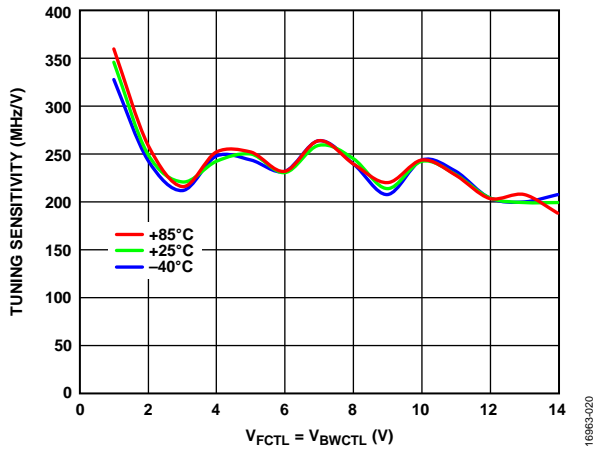

Figure 20. Tuning Sensitivity vs. $V_{FCTL} = V_{BWCTL}$ at Various Temperatures

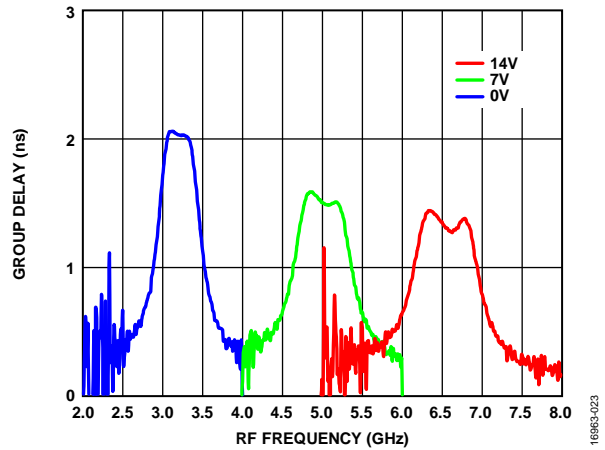

Figure 23. Group Delay vs. RF Frequency at Various Voltages, $V_{FCTL} = V_{BWCTL}$

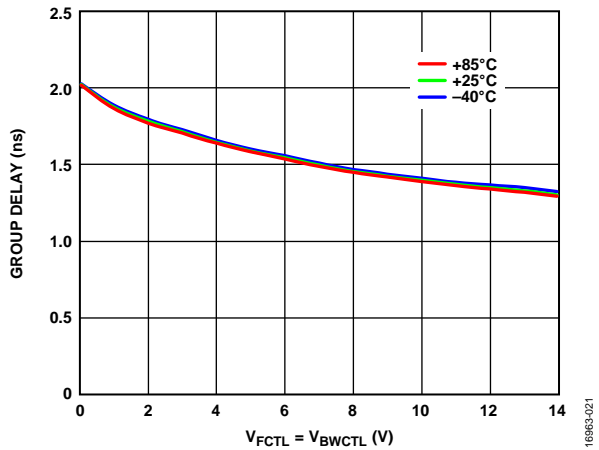

Figure 21. Group Delay vs. $V_{FCTL} = V_{BWCTL}$ at Various Temperatures

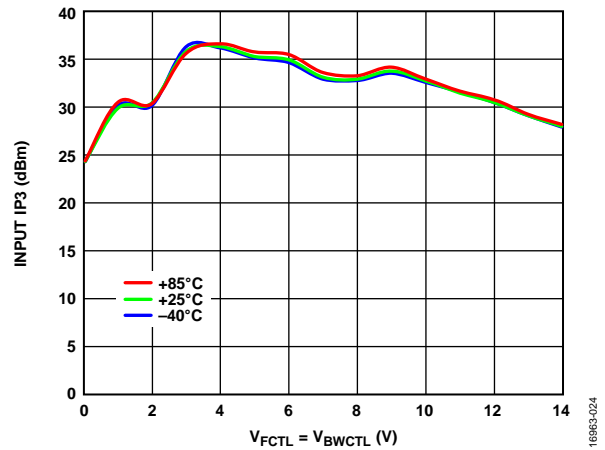

Figure 24. Input IP3 vs. $V_{FCTL} = V_{BWCTL}$ at Various Temperatures with an Input Power of 20 dBm

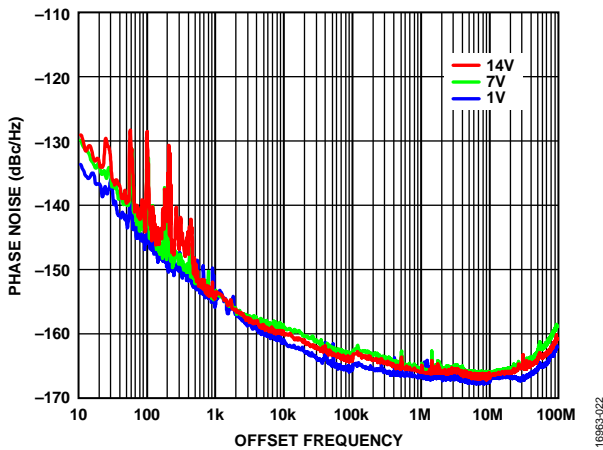

Figure 22. Phase Noise vs. Offset Frequency at Various Voltages, $V_{FCTL} = V_{BWCTL}$

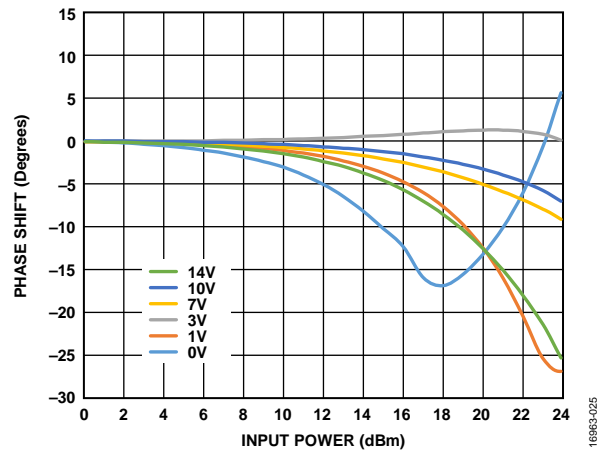

Figure 25. Phase Shift vs. Input Power at Various Voltages, $V_{FCTL} = V_{BWCTL}$

THEORY OF OPERATION

The HMC892ALP5E is a tunable band-pass filter that features a user selectable pass-band frequency. Varying the applied analog tuning voltage between 0 V and 14 V at the V_{FCTL} pin varies the center frequency between 3.45 GHz and 6.25 GHz. The bandwidth

of the filter is adjustable by using the V_{BWCTL} control voltage, which varies from 0 V to 14 V. Typical operation is to tie both V_{FCTL} and V_{BWCTL} control voltages together.

APPLICATIONS INFORMATION

TYPICAL APPLICATION CIRCUIT

Figure 26 shows the typical application circuit for the HMC892ALP5E. RFIN and RFOUT are dc-coupled and require external 100 pF series capacitors (C1 and C2).

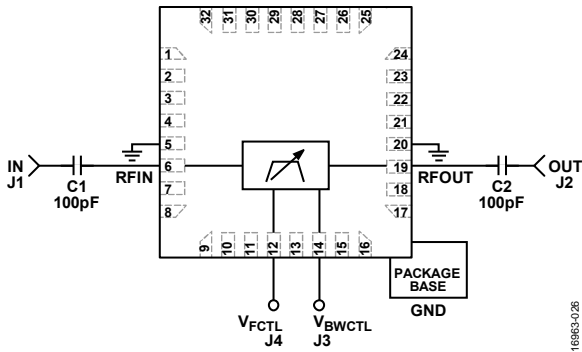

Figure 26. Typical Application Circuit

EVALUATION PCB INFORMATION

All RF traces are routed on Layer 1 (primary side), and all other layers are ground planes that provide a solid ground for RF transmission lines, as shown in Figure 27. The top dielectric material is Rogers 4350, offering low loss performance. The prepregged (PREPREG) material in Layer 2 sticks the Isola 370HR with copper trace layers above and below together. Both the PREPREG material and the Isola 370HR core layer are used to achieve required board finish thickness.

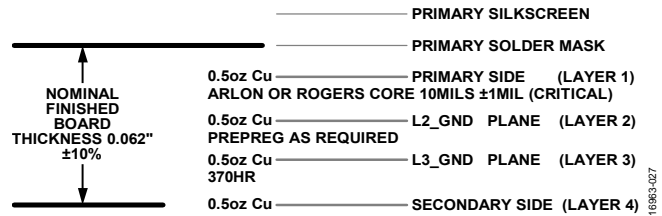

Figure 27. 4-Layer Stackup

The printed circuit board (PCB) used in the application uses radio frequency (RF) circuit design techniques. Signal lines must have a 50 Ω impedance while the package ground leads and exposed pad must be connected directly to the ground plane (see Figure 28). Use a sufficient number of via holes to connect the top and bottom ground planes. The evaluation PCB shown in Figure 28 is available from Analog Devices, Inc., upon request. The HMC890ALP5E evaluation board in Figure 28 is used to evaluate the HMC892ALP5E device.

Table 4. Bill of Materials

Item	Description
J1 to J2	PCB mounts SRI, SMA connector
J3 to J4	PCB mounts, Johnson SMA connector
C1, C2	100 pF capacitors, 0402 package
U1	HMC892ALP5E
PCB ¹	08-049598 ² evaluation PCB

¹ Circuit board material is Arlon 25FR or Rogers 25FR.

² 08-049598 is the raw bare PCB identifier. Reference EV1HMC891ALP5 when ordering the complete evaluation PCB.

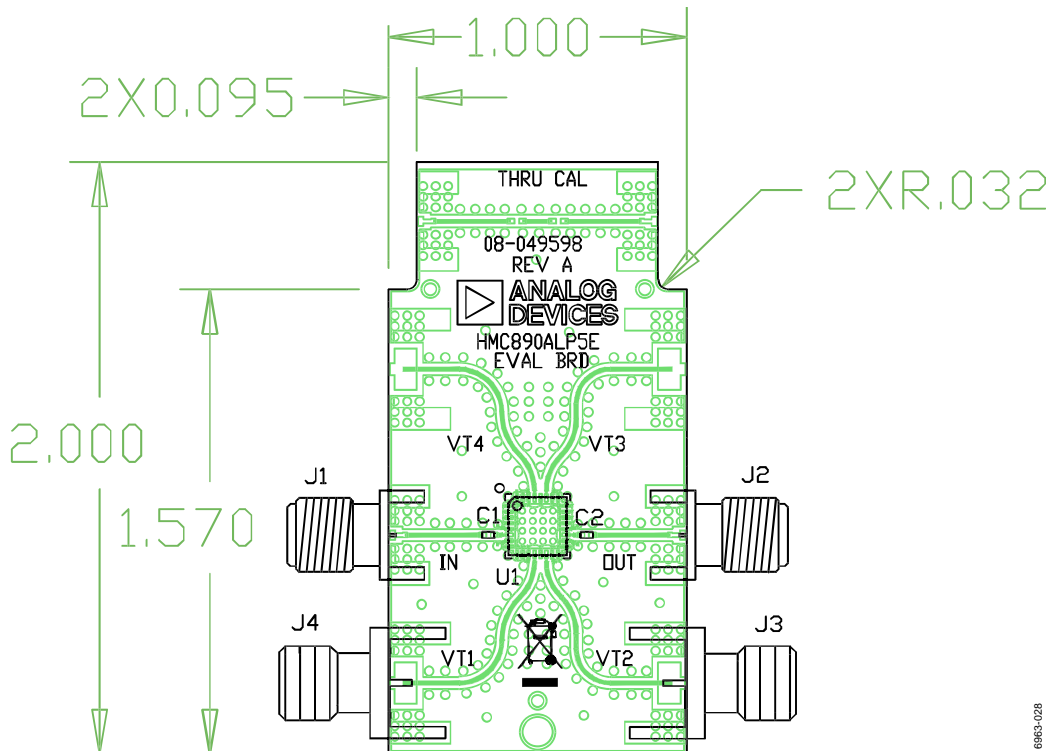

Figure 28. Evaluation PCB Top Layer