

DESCRIPTION

The EV2013A-J_Q_G-00A is an evaluation board for the MP2013A, MPQ2013A and MPQ2013A-AEC1, a low power linear regulator that supplies power to systems with high voltage batteries.

MP2013A/MPQ2013A/MPQ2013A-AEC1 includes a wide 2.5V to 40V input range, low dropout voltage and low quiescent supply current. The low quiescent current and low dropout voltage allow operations at extremely low power levels. Therefore, the MP2013A/MPQ2013A/MPQ2013A-AEC1 is ideal for the low power microcontrollers and the battery-powered equipments.

The EV2013A-J_Q_G-00A is a fully assembled and tested evaluation board. It generates a +5V output voltage at load current up to 150mA from a 6V to 40V input range.

ELECTRICAL SPECIFICATIONS

Parameter	Symbol	Value	Units
Input Voltage	V_{IN}	6 – 40	V
Output Voltage	V_{OUT}	5	V
Output Current	I_{OUT}	150	mA

FEATURES

- 6V to 40V Input Range
- 150mA Specified Current
- 620mV Dropout at 150mA Load
- Output $\pm 2\%$ Accuracy
- Specified Current Limit
- Thermal Shutdown
- -40°C to $+125^{\circ}\text{C}$ Specified Junction Temperature Range
- Includes QFN6 (2x2mm) and QFN8 (3x3mm) Packages

APPLICATIONS

- Industrial/Automotive Applications
- Portable/Battery-Powered Equipment
- Ultra low power Microcontrollers
- Cellular Handsets
- Medical Imaging

All MPS parts are lead-free, halogen free, and adhere to the RoHS directive. For MPS green status, please visit MPS website under Quality Assurance. "MPS" and "The Future of Analog IC Technology" are Registered Trademarks of Monolithic Power Systems, Inc.

EV2013A-J_Q_G-00A EVALUATION BOARD



(L x W x H) 2.5" x 2.5" x 0.4"
(6.35cm x 6.35cm x 1.0cm)

Board Number	MPS IC Number
EV2013A-J_Q_G-00A	MPQ2013A-GQ/GG

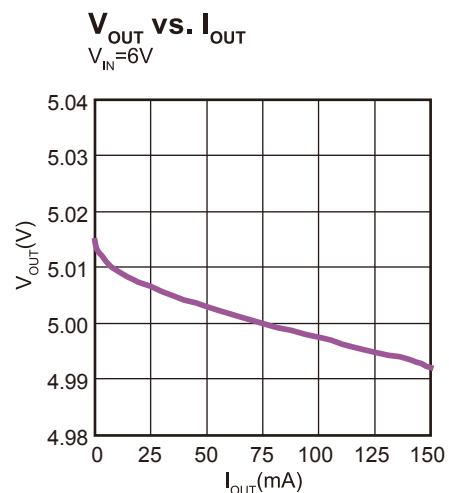

EVALUATION BOARD SCHEMATIC

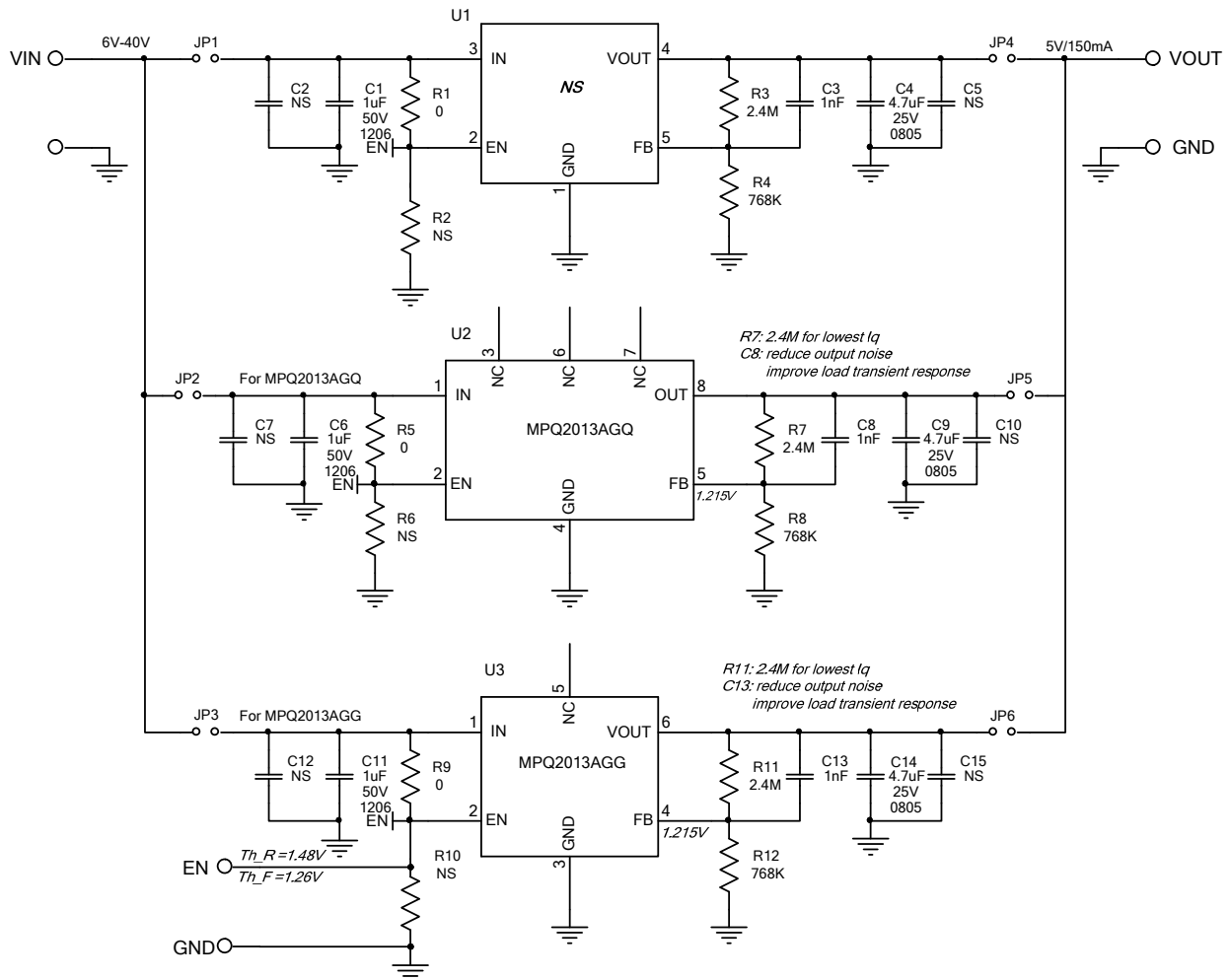

Reference for FB Divider Selection

V _{out} (V)	R7 (or R11, kΩ)	R8 (or R12, kΩ)
1.215	2400	NS
2.5	2400	2260
3.3	2400	1400
5	2400	768
12	2400	270

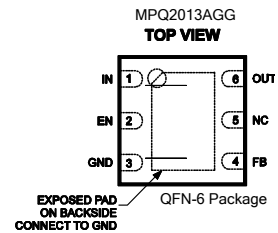
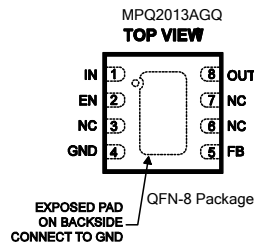

EV2013A-J_Q_G-00A BILL OF MATERIALS

Ref	Value	Description	Package	Manufacturer	Manufacturer_P/N
C1, C6, C11	1 μ F	Ceramic Cap., 50V, X7R	1206	muRata	GRM31MR71H105KA88L
C3, C8, C13	1nF	Ceramic Cap., 50V, X7R	0603	muRata	GRM188R71H102KA01D
C4, C9, C14	4.7 μ F	Ceramic Cap., 16V, X7R	0805	muRata	GCM21BR71C475KA73L
C2, C5, C7, C10, C12, C15	NS				
R1, R5, R9	0	Film Res., 5%	0603	Yageo	RC0603JR-070RL
R3, R7, R11	2.4M	Film Res., 1%	0603	Yageo	RC0603FR-072M4L
R4, R8, R12	768k	Film Res., 1%	0603	Yageo	RC0603FR-07768KL
R2, R6, R10	NS				
JP1, JP2, JP3, JP4, JP5, JP6		Jumper			
U1	NS				
U2		Linear Regulator	QFN8-3x3	MPS	MPQ2013AGQ-AEC1
U3		Linear Regulator	QFN6-2x2	MPS	MPQ2013AGG-AEC1
VIN, GND, VOUT, GND		2.0 Golden Pin		HZ	
EN, GND		2.54mm Test Pin		any	

EVB TEST RESULTS

Performance waveforms are tested on the evaluation board.

$V_{OUT} = 5V$, $T_A = 25^\circ C$, unless otherwise noted.

Ground Current vs. Load Current

$V_{IN} = 6V$

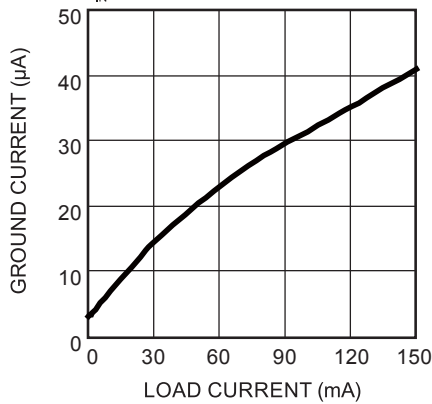

Ground Current vs. V_{IN}

$I_o = 0mA$

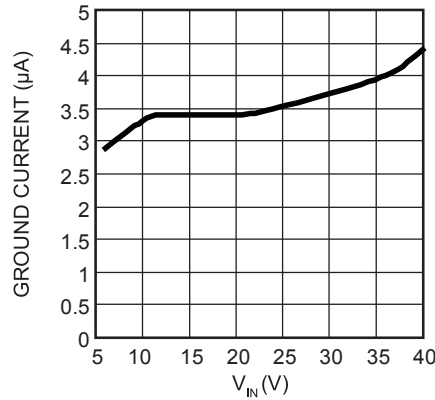

Dropout Voltage vs. Load Current

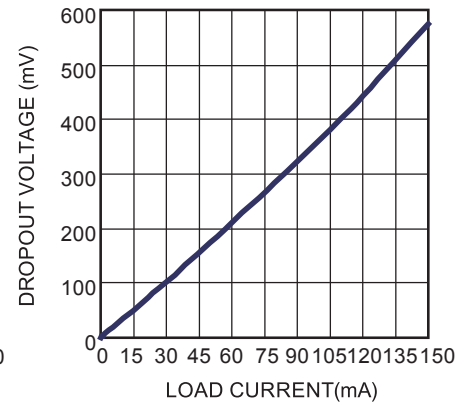

V_{OUT} vs. I_{OUT}

$V_{IN} = 6V$

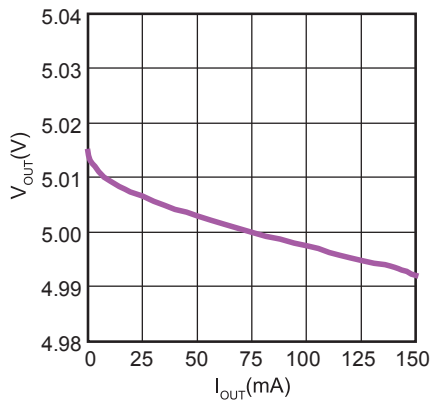

V_{OUT} vs. V_{IN}

$V_o = 5V$

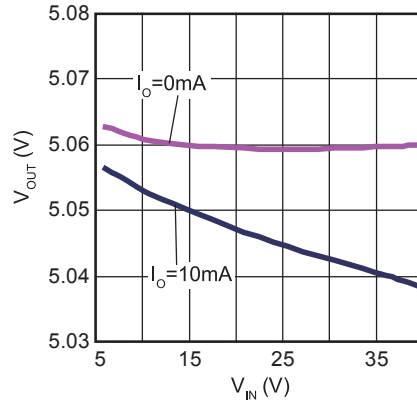

PSRR vs. Frequency

$V_{IN1} = V_{IN2} = 6V$, $I_o = 10mA$, $C_{IN} = 100pF$

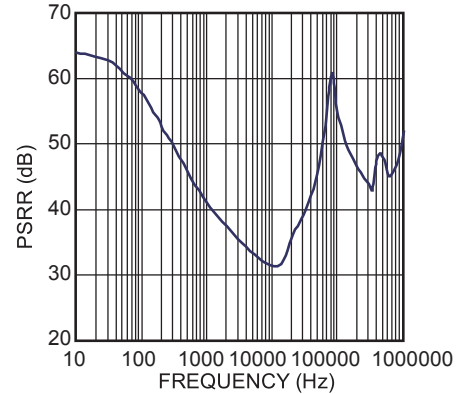

EVB TEST RESULTS *(continued)*

Performance waveforms are tested on the evaluation board.

$V_{OUT} = 5V$, $T_A = 25^{\circ}C$, unless otherwise noted.

Load Transient

$V_{IN} = 12V$, $I_{OUT} = 8mA-150mA$

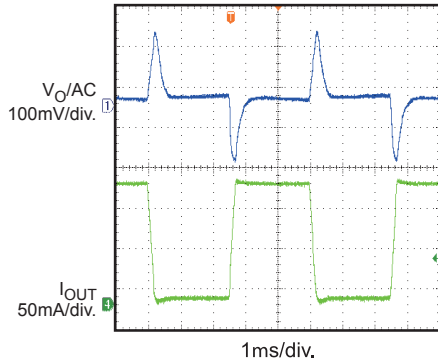

Line Transient

$V_{IN} = 6V-7V$, $I_{OUT} = 150mA$

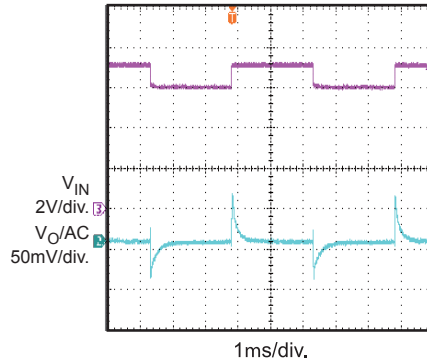

Startup Through V_{IN}

$V_{IN} = 12V$, $I_{OUT} = 150mA$

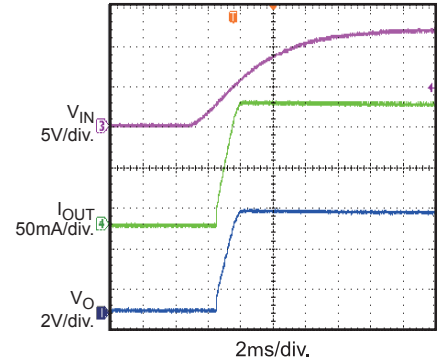

Shutdown Through V_{IN}

$V_{IN} = 12V$, $I_{OUT} = 150mA$

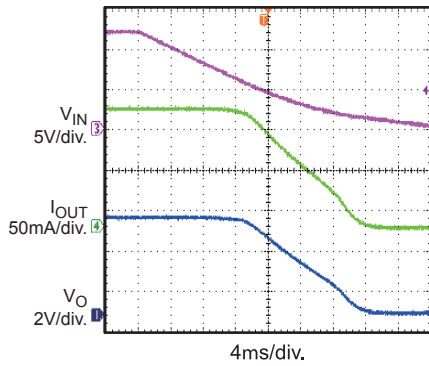

Short Circuit Entry

$V_{IN} = 12V$, $I_{OUT} = 0mA$ to short circuit

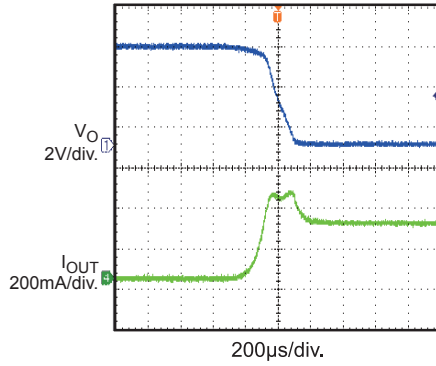

Short Circuit Recovery

$V_{IN} = 12V$, short circuit to $I_{OUT} = 0mA$

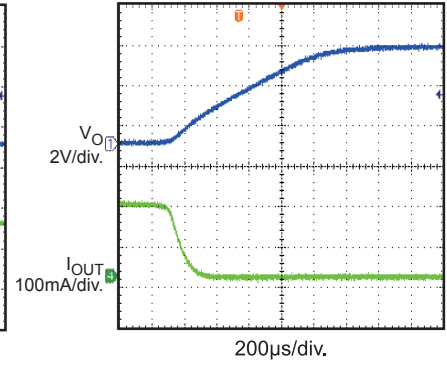

Short Circuit Steady State

$V_{IN} = 12V$

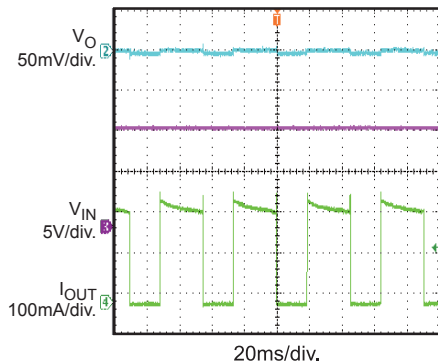

PRINTED CIRCUIT BOARD LAYOUT

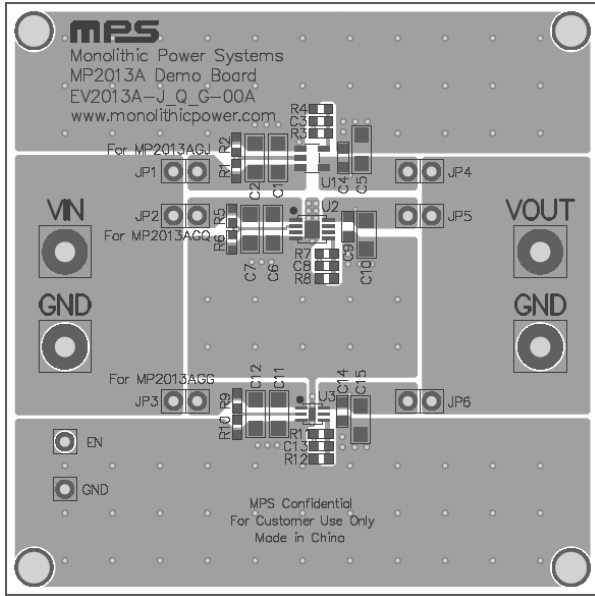

Figure 1—Top Silk & Top Layer

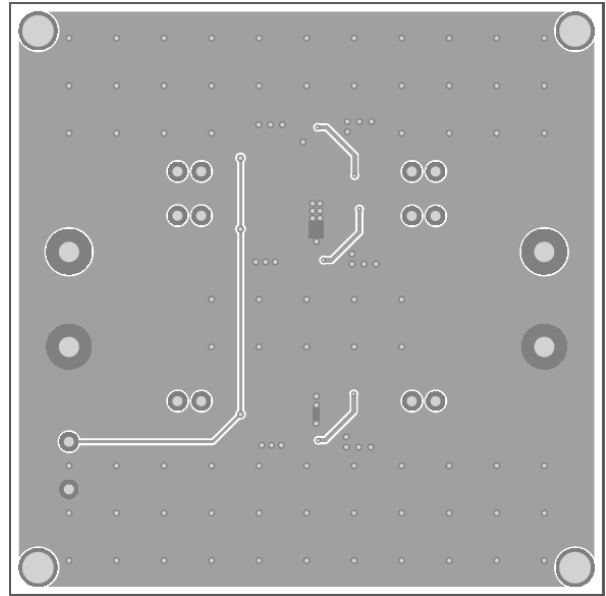

Figure 2—Bottom Layer

QUICK START GUIDE

1. Connect different jumpers to select different MPQ2013A ICs with different packages for evaluation:

Connected Jumpers	Selected IC
JP2, JP5	MPQ2013AGQ
JP3, JP6	MPQ2013AGG

2. Connect the positive and negative terminals of the load to the VOUT and GND pins, respectively. Set load current between 0-150mA. Be aware that electronic loads represent a negative impedance to the regulator and if set to a too high current will trigger over-current-protection or short-current-protection.
3. Preset the power supply output between 6V and 40V, and then turn it off. If longer cables are used between the source and the EVB (>0.5m total), a damping capacitor should be installed at the input terminals, especially when $V_{IN} \geq 24V$.
4. Connect the positive and negative terminals of the power supply output to the VIN and GND pins, respectively.
5. Turn the power supply on. The MPQ2013A will automatically startup. The default V_{OUT} is 5V.
6. To use EN turning on/off MPQ2013A, remove R5 or R9 first. Then give a voltage between EN and GND higher than 1.48V to turn on, lower than 1.26V to turn off.