

DESCRIPTION

The EV2187-QA-01A evaluation Board is designed to demonstrate the capabilities of MP2187, an internally compensated 1.2MHz dual COT synchronous step-down regulator. The output voltages of the two channels are 1.1V and 1.8V respectively.

The constant-on-time control scheme provides fast transient response and eases loop stabilization. Fault condition protections include cycle-by-cycle current limiting and thermal shutdown.

The MP2187 is available in small 2.2mmx2.6mm QFN16 package and requires only a minimal number of readily available standard external components.

ELECTRICAL SPECIFICATION

Parameter	Symbol	Value	Units
Input Voltage Range ⁽¹⁾	V_{IN}	3.6-5.5	V
Output Voltages	V_{OUT1}	1.1	V
	V_{OUT2}	1.8	V
Load Current	I_{OUT1}	3	A
	I_{OUT2}	3	A

Note (1): Low V_{IN} application may need more input capacitors.

FEATURES

- 2.5V to 5.5V Input Voltage Range
- Fixed Output Voltages: 1.1V, 1.8V
- 100% Duty Cycle in Dropout
- Up to 3A Output Current
- Low IQ: 80 μ A
- 60m Ω and 30m Ω Internal Power MOSFET Switches
- Default 1.2MHz Switching Frequency
- EN and Power-Good for Power Sequencing
- Cycle-by-Cycle Over-Current Protection
- Auto Discharge at Power-Off
- Short-Circuit Protect with Hiccup Mode
- Stable with Low-ESR Output Ceramic Capacitors
- Available in a 2.2mm x 2.6mm QFN16 Package

APPLICATIONS

- Solid State Drives(SSD)
- Low Voltage I/O System Power
- Handheld/Battery-powered Systems
- Wireless/Networking Cards

All MPS parts are lead-free and adhere to the RoHS directive. For MPS green status, please visit MPS website under Quality Assurance. "MPS" and "The Future of Analog IC Technology", are Registered Trademarks of Monolithic Power Systems, Inc.

EV2187-QA-01A EVALUATION BOARD



Board Number	MPS IC Number
EV2187-QA-01A	MP2187GQA

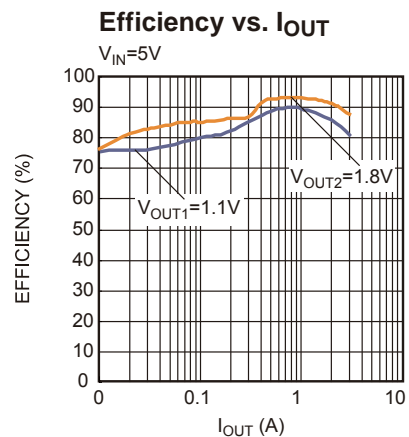

EVALUATION BOARD SCHEMATIC

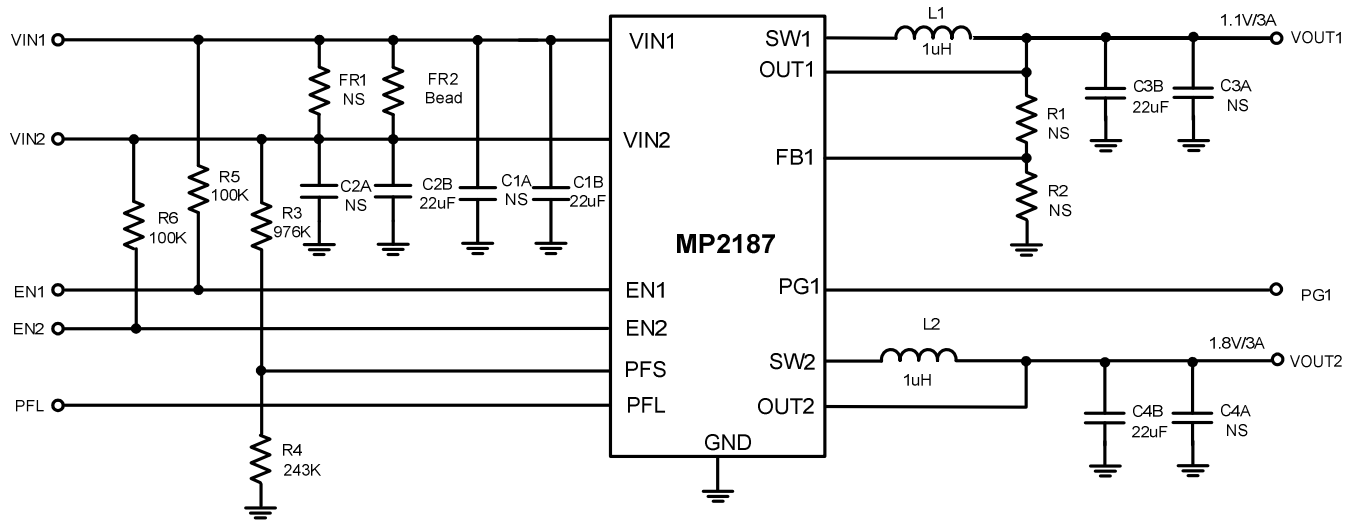

EV2187-QA-01A BILL OF MATERIALS

Qty	Ref	Value	Description	Package	Manufacturer	Manufacturer P/N
2	C1B, C2B	22 μ F	Ceramic Cap., 10V, X5R	1206	muRata	GRM31CR61A226ME19L
2	C3B, C4B	22 μ F	Ceramic Cap, 6.3V, X5R	1206	muRata	GRM31CR60J226KE19L
0	C1A, C2A, C3A, C4A, FR1	NS	NS	NS	NS	NS
1	FR2	Bead	390m Ω @100MHz, Ir=2A	1206	muRata	BLM31PG601SN1L
0	R1, R2, ,	NS	NS	NS	NS	NS
1	R3	976k	Film Res., 1%	0603	ROYAL	RL0603FR-07976KL
1	R4	243k	Film Res., 1%	0603	ROYAL	RL0603FR-07243KL
2	R5, R6	100k	Film Res., 5%	0603	ROYAL	RL0603FR-07100KL
2	L1, L2	1 μ H	Inductor Isat=10.2A		Wurth	744777001
1	U1	MP2187	Step Down Switcher	QFN	MPS	MP2187

EVB TEST RESULTS

Performance waveforms are tested on the evaluation board.

$V_{IN} = 5V$, $V_{OUT1} = 1.1V$, $V_{OUT2} = 1.8V$, $L1=L2 = 1\mu H$, $C_{OUT1}=C_{OUT2}=22\mu F$, $T_A = 25^\circ C$, unless otherwise noted.

Efficiency vs. I_{OUT}

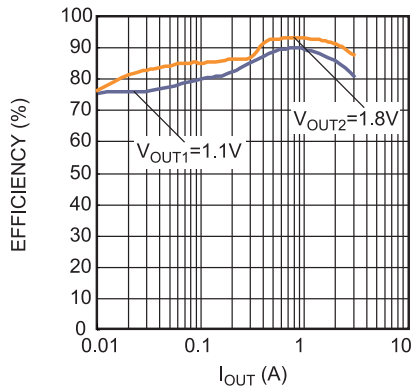

Load Regulation

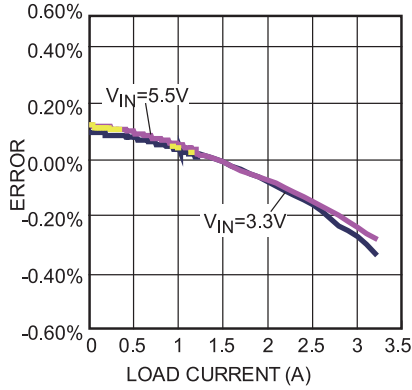

Line Regulation

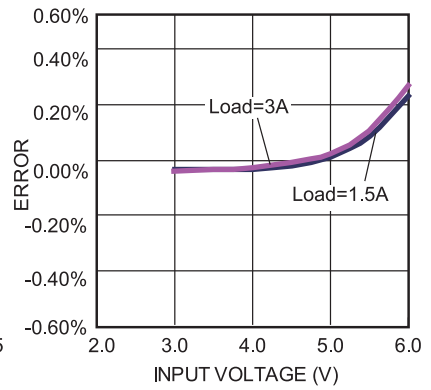

Quiescent Current vs. Temperature

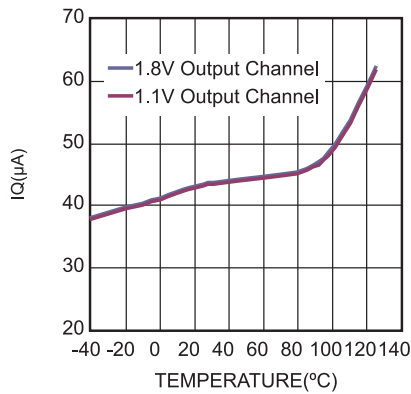

Case Temperature Rise ($T_{case}-T_{ambient}$) vs. I_{OUT}

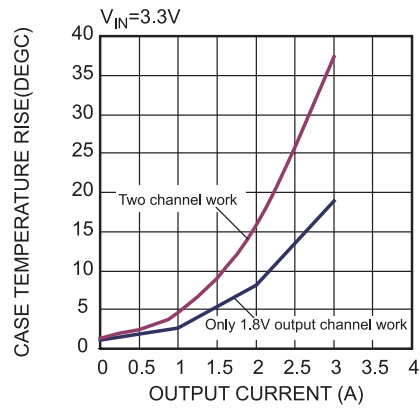

Output Voltage vs. Temperature

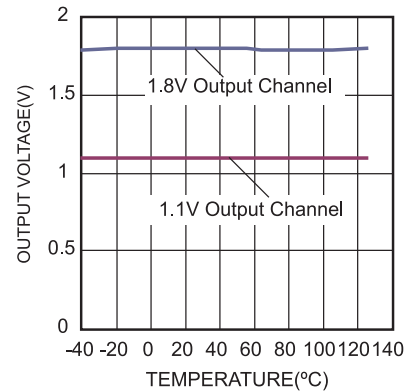

Feedback Voltage vs. Temperature

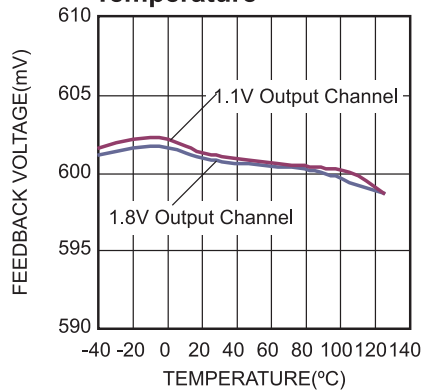

EVB TEST RESULTS (continued)

Performance waveforms are tested on the evaluation board.

$V_{IN} = 5V$, $V_{OUT1} = 1.1V$, $V_{OUT2} = 1.8V$, $L1=L2 = 1\mu H$, $C_{OUT1}=C_{OUT2}=22\mu F$, $T_A = 25^\circ C$, unless otherwise noted.

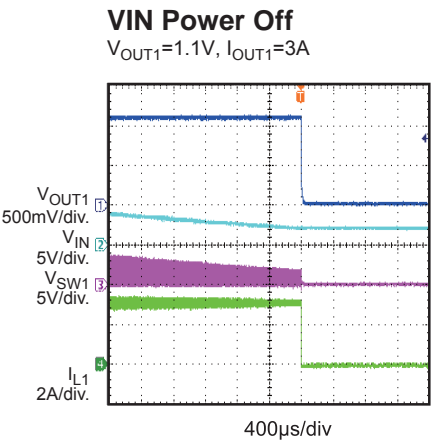
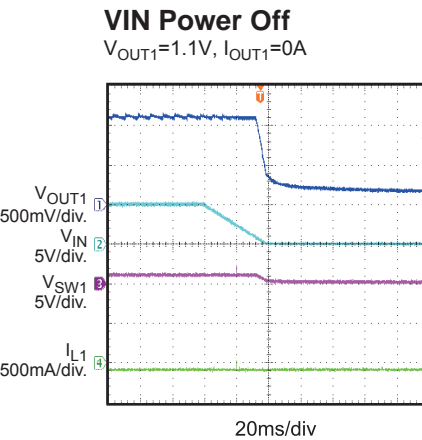
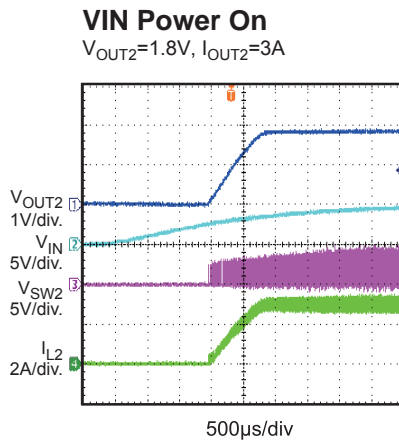
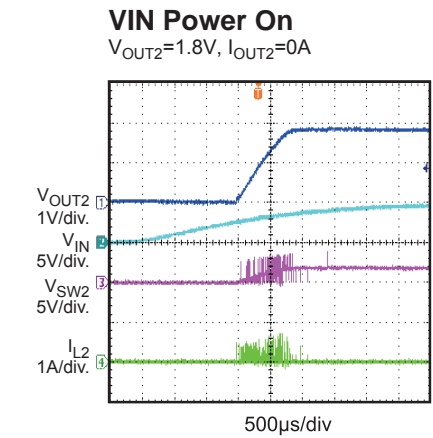
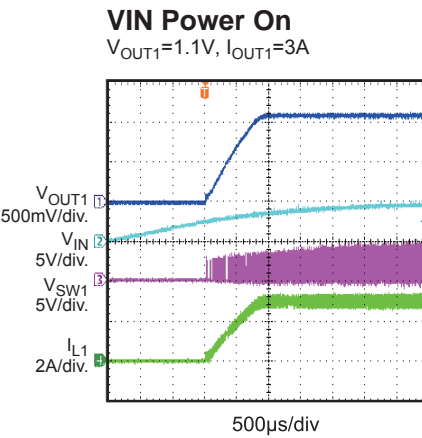
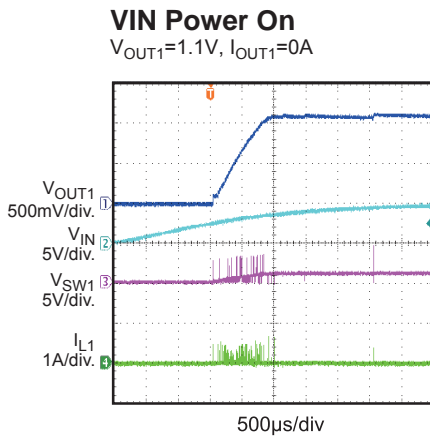
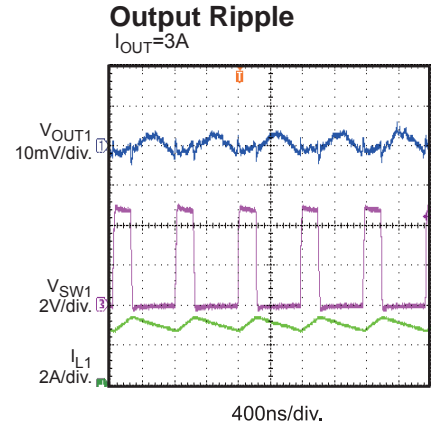
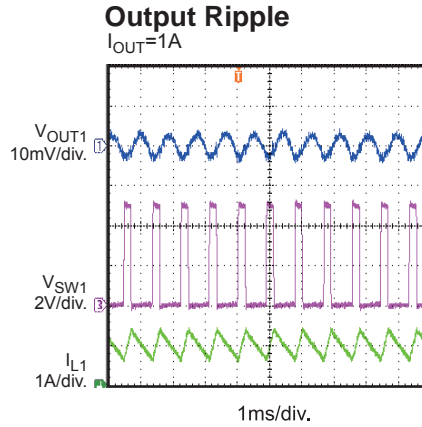
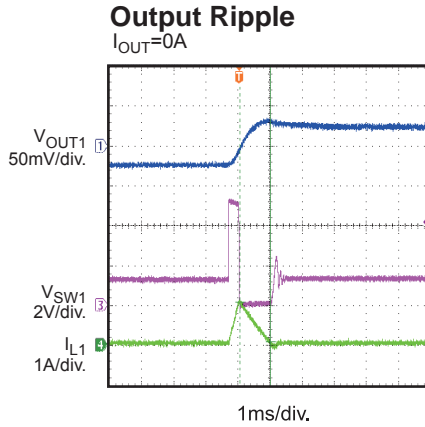

EVB TEST RESULTS *(continued)*

Performance waveforms are tested on the evaluation board.

$V_{IN} = 5V$, $V_{OUT1} = 1.1V$, $V_{OUT2} = 1.8V$, $L1=L2 = 1\mu H$, $C_{OUT1}=C_{OUT2}=22\mu F$, $T_A = 25^\circ C$, unless otherwise noted.

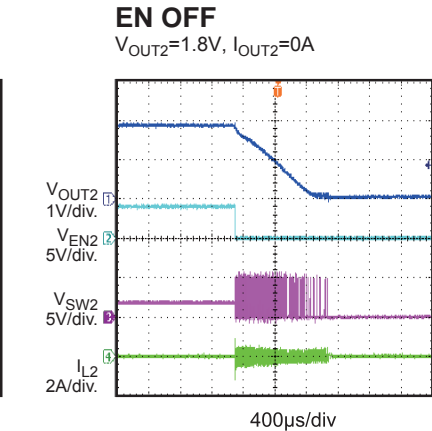
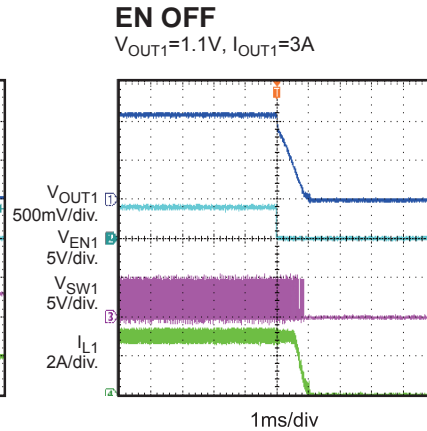
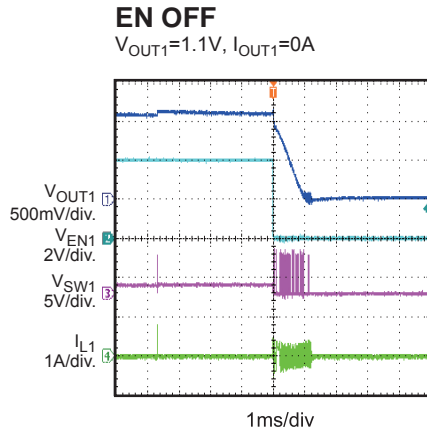
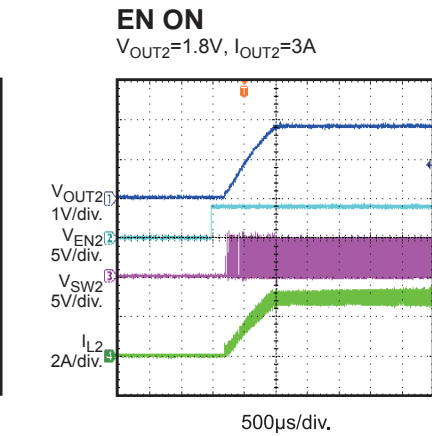
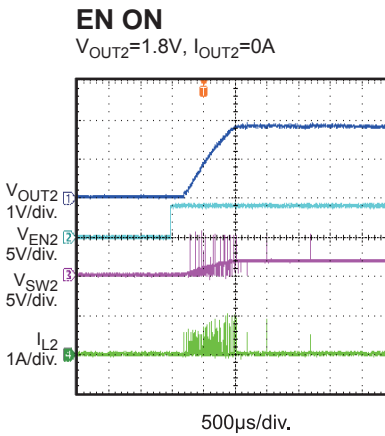
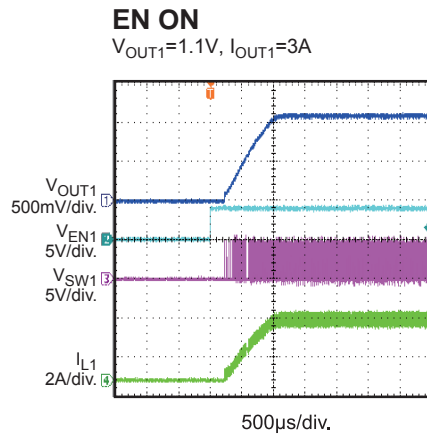
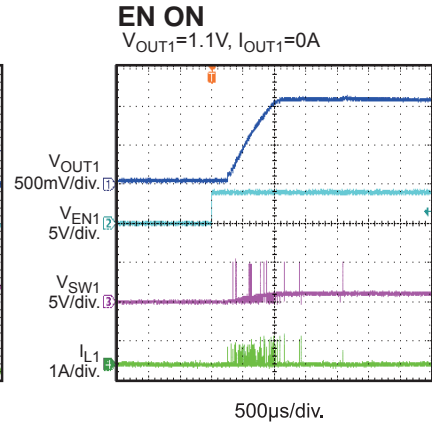
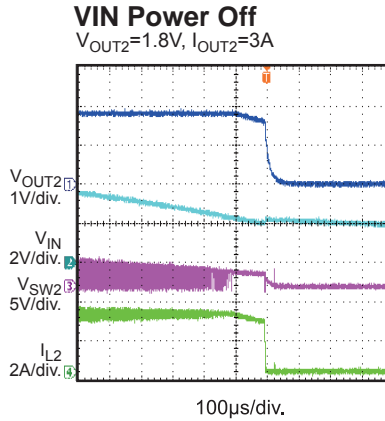
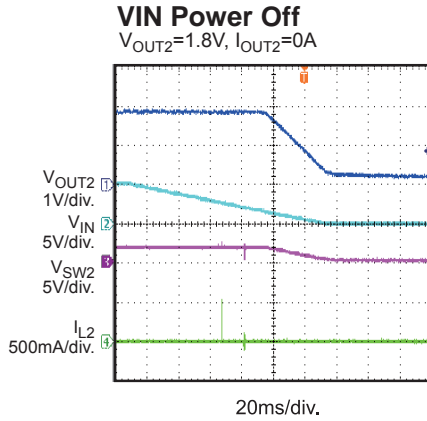

EVB TEST RESULTS (continued)

Performance waveforms are tested on the evaluation board.

$V_{IN} = 5V$, $V_{OUT1} = 1.1V$, $V_{OUT2} = 1.8V$, $L1=L2 = 1\mu H$, $C_{OUT1}=C_{OUT2}=22\mu F$, $T_A = 25^\circ C$, unless otherwise noted.

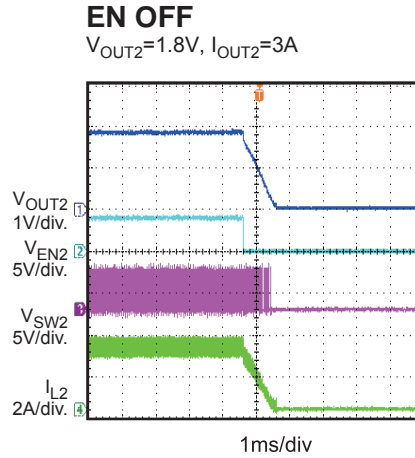

PRINTED CIRCUIT BOARD LAYOUT

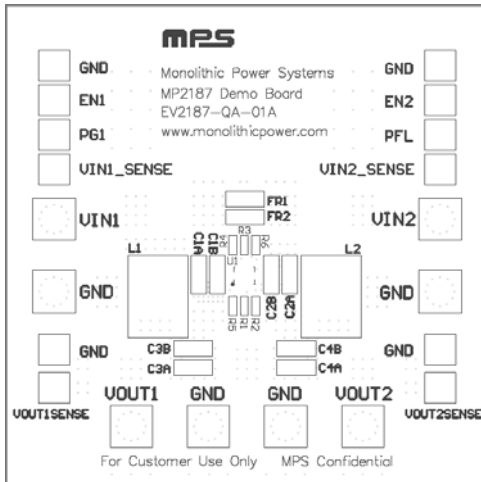

Figure 1—Top Silk Layer

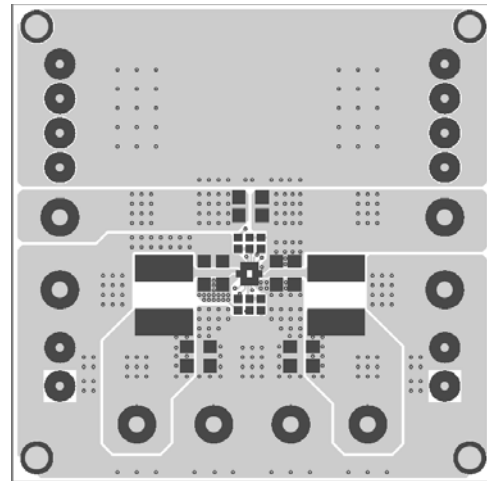

Figure 2—Top Layer

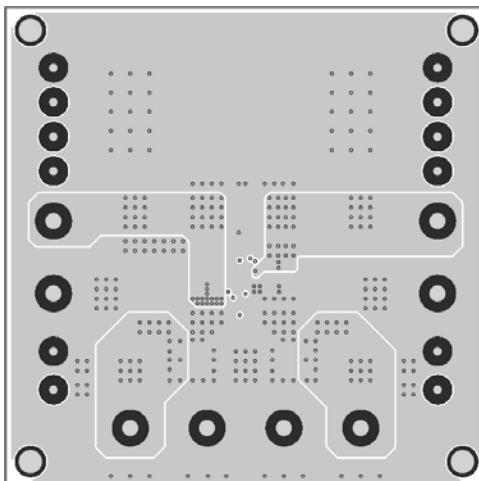

Figure 3—Inner 1 Layer

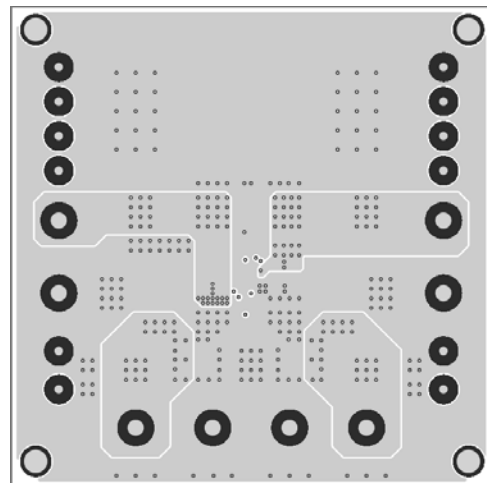

Figure 4—Inner 2 Layer

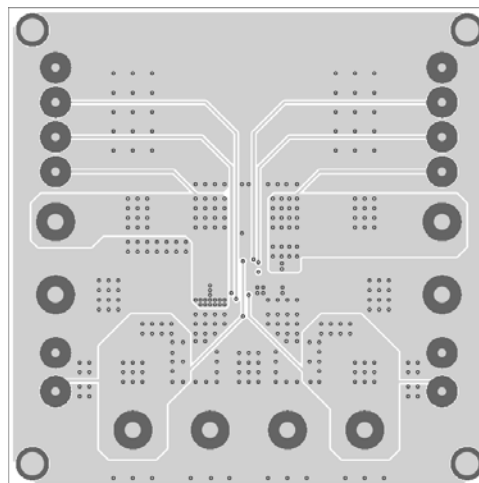
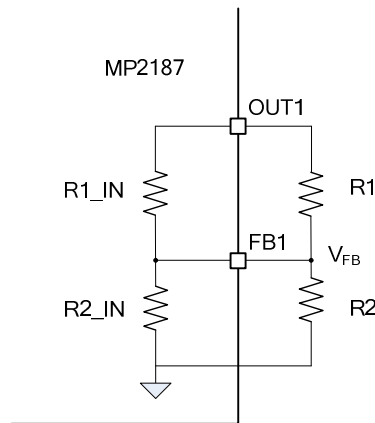

Figure 5—Bottom Layer

QUICK START GUIDE

1. Connect the positive and negative terminals of the load to the VOUT and GND pins, respectively.
2. Preset the power supply output between 3.6V and 5.5V, and then turn off the power supply.
3. Connect the positive and negative terminals of the power supply output to the VIN and GND pins, respectively.
4. Turn the power supply on. The board will automatically start up. And the output voltages are the pre-set fixed 1.1V and 1.8V.
5. To use the Enable function, apply a digital input to the EN pin. Drive EN higher than 1.2V to turn on the regulator or less than 0.4V to turn it off.
6. The 1.1V output voltage can be changed by external FB divider resistors. Figure 6 shows the MP2187 feedback network.

Figure 6 — Feedback network

Considering the internal divider resistors, choose external FB divider resistors $R_1+R_2 < 20k\Omega$. Using below formulas to set the new output voltages:

$$R_1 = \frac{V_O - V_{FB}}{V_{FB}} \times R_2$$

Where, $V_{FB} = 0.6V$.