



The Future of Analog IC Technology®

EV2322-D-00A

1A, 22V, Low IQ

Step Down Converter Evaluation Board

DESCRIPTION

The EV2322-D-00A Evaluation Board is designed to demonstrate the capabilities of MPS' MP2322, a high light load efficiency synchronous rectified step-down switch mode converter with built in internal power MOSFETs. It offers a very compact solution to achieve 1A continuous output current over a wide input supply range with excellent load and line regulation.

The MP2322 switching edge is optimized for EMI reducing. COT (Constant On Time) control provides seamless mode transition and fast load transient response.

Full protection features include OCP, OVP and thermal shut down.

The MP2322 requires 7 of readily available standard external components and is available in a space saving QFN-8(1.5mmx2mm) package.

ELECTRICAL SPECIFICATION

Parameter	Symbol	Value	Units
Input Voltage	V _{IN}	12	V
Output Voltage	V _{OUT}	3.3	V
Output Current	I _{OUT}	1	A

FEATURES

- Wide 3V to 22V Operating Input Range
- 5µA Low IQ
- 1A Load Current, 500mA trim version
- 260mΩ/120mΩ R_{ds(on)} Internal Power MOSFETs
- High Efficiency from 100µA to 1A Load
- Power Save Mode in Light Load Condition
- 1.25MHz Switching Frequency
- T_{ON} Extension to Support Large Duty Cycle
- Power Good Indication
- EN shutdown discharge
- OCP and OVP Protection and Hiccup
- Fast Load Transient Response
- Stable with both large ESR capacitor and ceramic capacitor
- Output Adjustable from 0.6V
- Available in small QFN-8(1.5mmx2mm) package

APPLICATIONS

- Home Automation, Home Security
- Single or Multi Cell Li-ion Battery System
- Multi Cell Dry Battery System
- 12V Input Power Rails
- White Goods

All MPS parts are lead-free and adhere to the RoHS directive. For MPS green status, please visit MPS website under Products, Quality Assurance page.

"MPS" and "The Future of Analog IC Technology", are Registered Trademarks of Monolithic Power Systems, Inc.

EV2322-D-00A EVALUATION BOARD

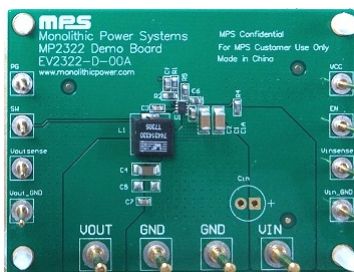

(L × W × H) 64mm × 48mm × 1.6mm

Board Number	MPS IC Number
EV2322-D-00A	MP2322GQH

Efficiency vs. Output Current

V_{OUT}=3.3V, L=3.3µH

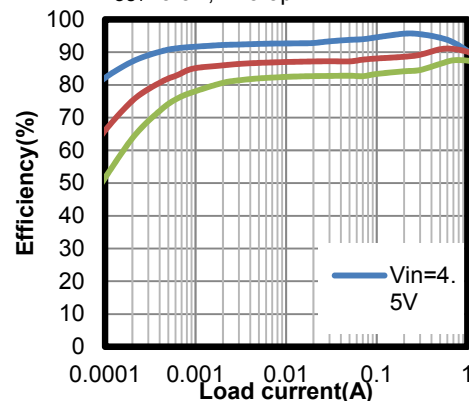

EVALUATION BOARD SCHEMATIC

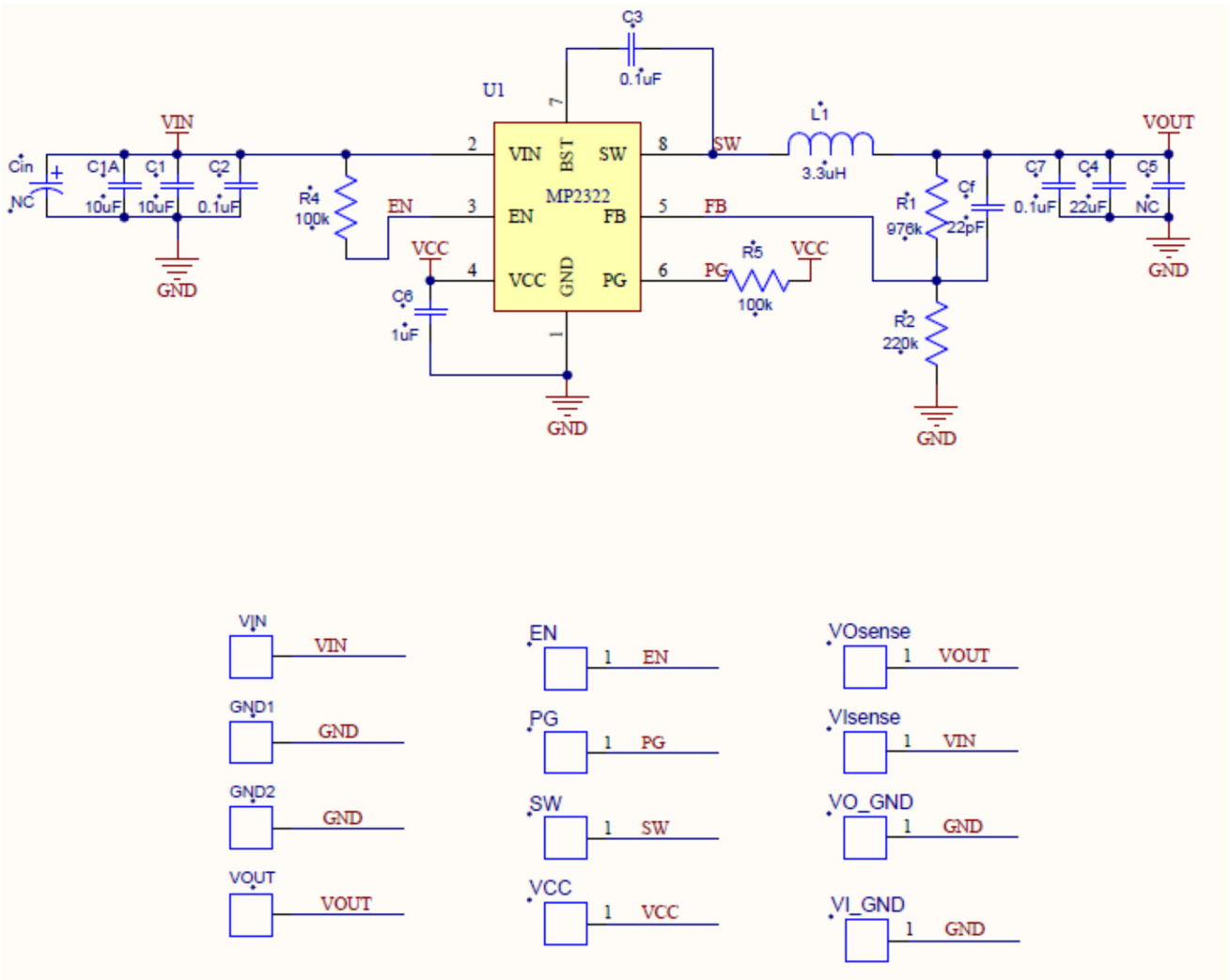

EV2322-D-00A BILL OF MATERIALS

Quantity	Designator	Value	Description	Package	Manufacturer	Manufacturer P/N
2	C1, C1A	10 μ F	Ceramic Cap.,25V,X5R	1206	Murata	GRM31CR61E106KA12L
3	C2, C3,C7	100nF	Ceramic Cap.,25V,X7R	0603	Murata	GRM188R71E104KA01D
1	C4	22 μ F	Ceramic Cap.,16V,X5R	1206	Murata	GRM31CR61C226ME15L
1	Cf	22pF	Ceramic Cap.,50V,COG	0603	Murata	GRM1885C1H220JA01D
1	C6	1 μ F	Ceramic Cap.,10V,X5R	0603	Murata	GRM188R61A105KA61D
1	R1	976K	Film Res,1%,0603,976K	0603	YAGEO	RC0603FR-07976KL
1	R2	220K	Film Res,1%,0603,220K	0603	YAGEO	RC0603FR-07220KL
2	R4, R5	100K	Film Res,1%,0603,100K	0603	YAGEO	RC0603FR-07100KL
8	1mm golden pin	ϕ 1.0	ϕ 1copper pin	DIP	N/A	ϕ 1.0 copper pin
4	2mm golden pin	ϕ 2.0	ϕ 2.0copper pin	DIP	N/A	ϕ 2.0 copper pin
1	L1	3.3 μ H	Inductor, DCR=9mohm, Isat=9A	7.0*6.9	Wurth	744314330
1	U1	MP2322	Synchronous step down convertor	QFN-8 (1.5mmx2mm)	MPS	MP2322

EVB TEST RESULTS

Performance waveforms are tested on the evaluation board.

$V_{IN} = 12V$, $V_{OUT} = 3.3V$, $L = 3.3\mu H$, $T_A = 25^\circ C$, unless otherwise noted.

Input/Output Ripple

$I_{OUT} = 0A$

CH1: V_{OUT}/AC
20mV/div.
CH2: V_{IN}/AC
100mV/div.
CH3: V_{SW}
10V/div.
CH4: I_L
500mA/div.

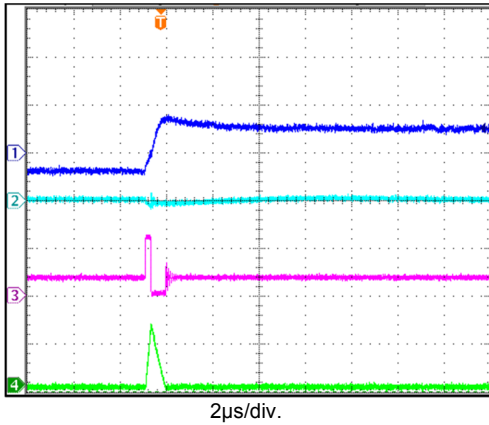

Input/Output Ripple

$I_{OUT} = 1A$

CH1: V_{OUT}/AC
20mV/div.
CH2: V_{IN}/AC
100mV/div.
CH3: V_{SW}
10V/div.
CH4: I_L
1A/div.

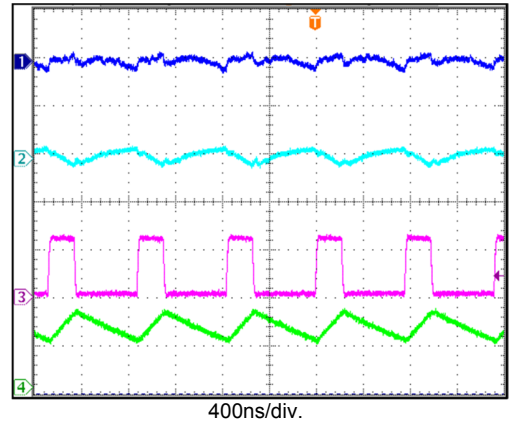

Start-up through Input Voltage

$I_{OUT} = 0A$

CH1: V_{OUT}
2V/div.
CH2: V_{IN}
5V/div.
R2: VPG
5V/div.
CH3: V_{SW}
5V/div.
CH4: I_L
2A/div.

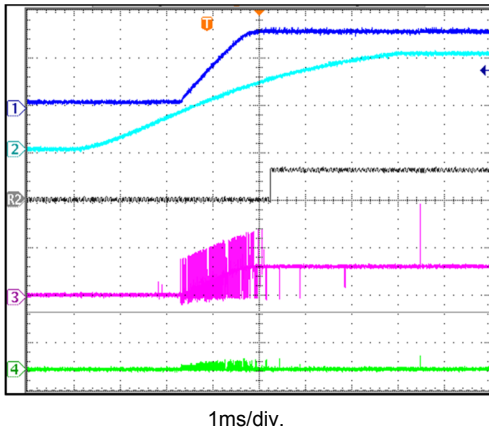

Start-up through Input Voltage

$I_{OUT} = 1A$

CH1: V_{OUT}
2V/div.
CH2: V_{IN}
5V/div.
R2: VPG
5V/div.
CH3: V_{SW}
5V/div.
CH4: I_L
2A/div.

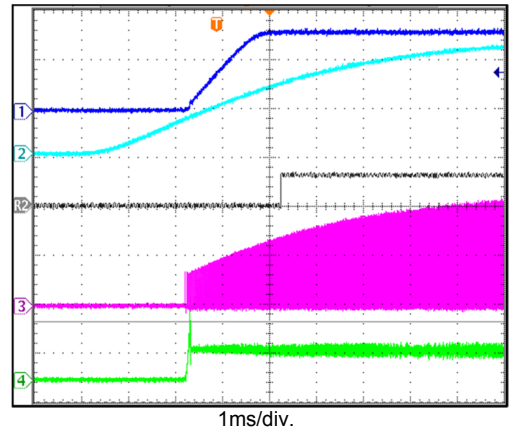

Shutdown through Input Voltage

$I_{OUT} = 0A$

CH1: V_{OUT}
2V/div.
CH2: V_{IN}
5V/div.
R2: VPG
5V/div.
CH3: V_{SW}
5V/div.
CH4: I_L
2A/div.

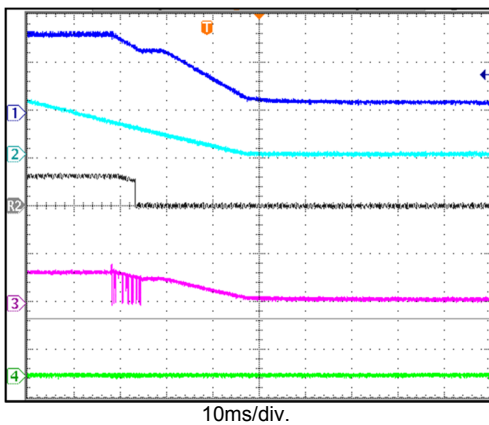

Shutdown through Input Voltage

$I_{OUT} = 1A$

CH1: V_{OUT}
2V/div.
CH2: V_{IN}
5V/div.
R2: VPG
5V/div.
CH3: V_{SW}
5V/div.
CH4: I_L
2A/div.

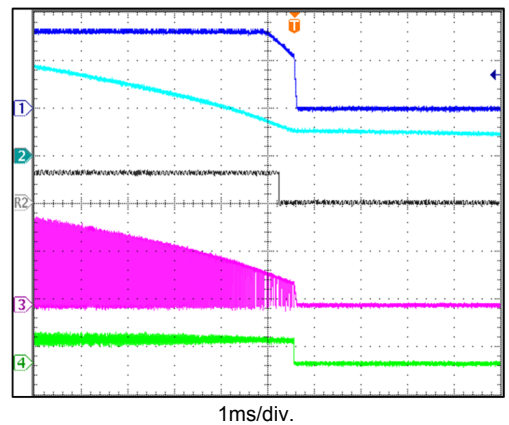

EVB TEST RESULTS (continued)

Performance waveforms are tested on the evaluation board.

$V_{IN} = 12V$, $V_{OUT} = 3.3V$, $L = 3.3\mu H$, $T_A = 25^\circ C$, unless otherwise noted.

Start-up through EN

$I_{OUT}=0A$

CH1: V_{OUT}
2V/div.
CH2: V_{EN}
5V/div.
R2: VPG
5V/div.
CH3: V_{SW}
10V/div.
CH4: IL
2A/div..

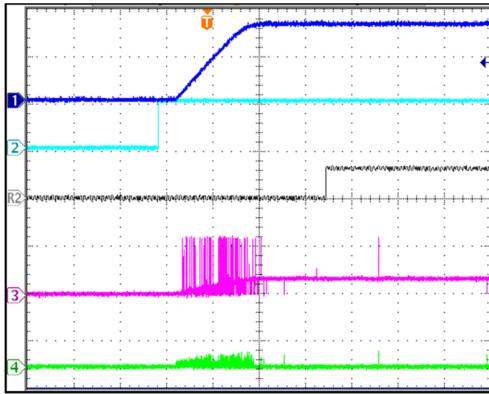

1ms/div.

Start-up through EN

$I_{OUT}=1A$

CH1: V_{OUT}
2V/div.
CH2: EN
5V/div.
R2: VPG
5V/div.
CH3: V_{SW}
10V/div.
CH4: IL
2A/div.

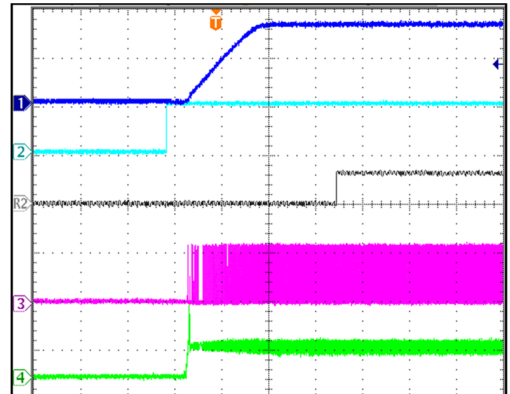

1ms/div.

Shutdown through EN

$I_{OUT}=0A$

CH1: V_{OUT}
2V/div.
CH2: EN
5V/div.
R2: VPG
5V/div.
CH3: V_{SW}
10V/div.
CH4: IL
2A/div.

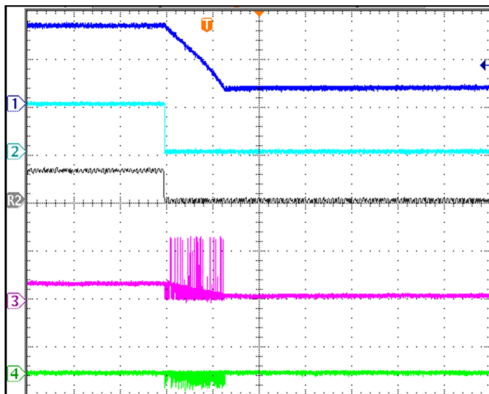

1ms/div.

Shutdown through EN

$I_{OUT}=1A$

CH1: V_{OUT}
2V/div.
CH2: EN
5V/div.
R2: VPG
5V/div.
CH3: V_{SW}
10V/div.
CH4: IL
2A/div.

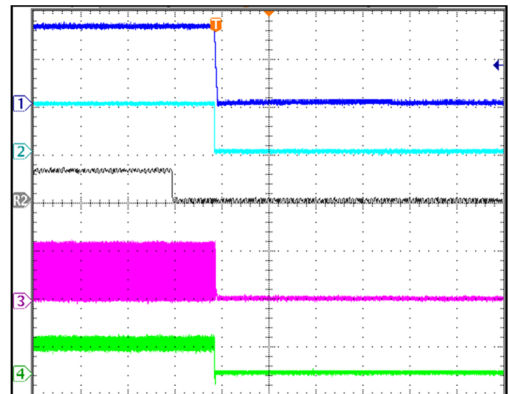

1ms/div.

Short Circuit Protection Entry

CH1: V_{OUT}
2V/div.
R2: VPG
5V/div.
CH3: V_{SW}
10V/div.
CH4: IL
2A/div.

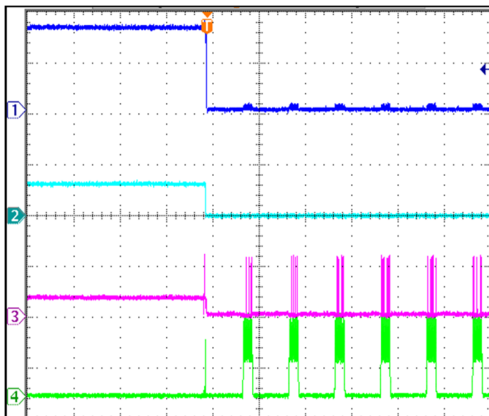

4ms/div.

Short Circuit Protection Recovery

CH1: V_{OUT}
2V/div.
R2: VPG
5V/div.
CH3: V_{SW}
10V/div.
CH4: IL
2A/div.

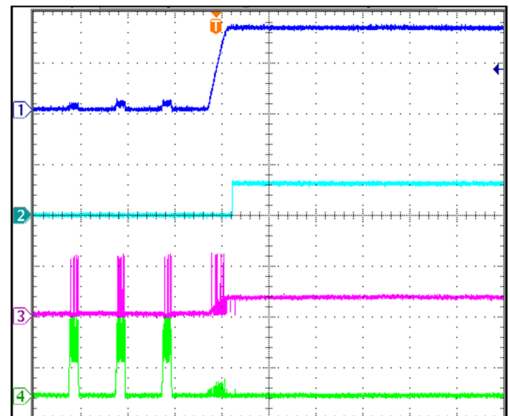

4ms/div.

EVB TEST RESULTS (continued)

Performance waveforms are tested on the evaluation board.

$V_{IN} = 12V$, $V_{OUT} = 3.3V$, $L = 3.3\mu H$, $T_A = 25^\circ C$, unless otherwise noted.

Load Transient Response

$I_{OUT} = 0.5A$ to $1A$, $2.5A/\mu s$

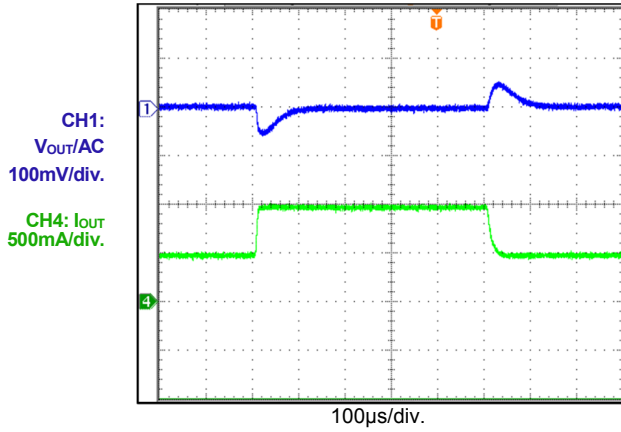

PRINTED CIRCUIT BOARD LAYOUT

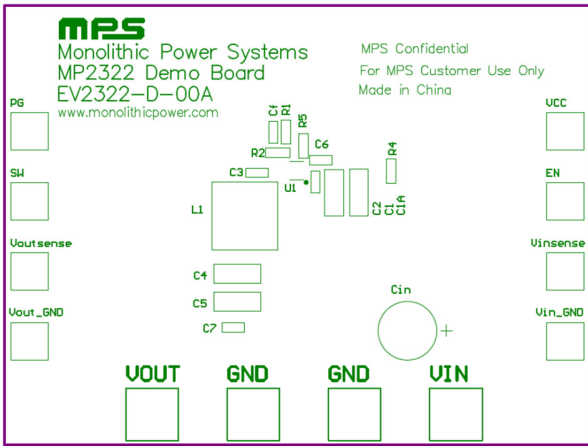

Figure 1: Top Silk Layer

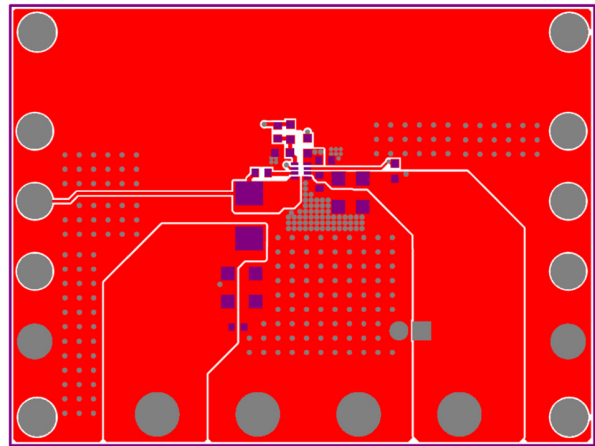

Figure 2: Top Layer

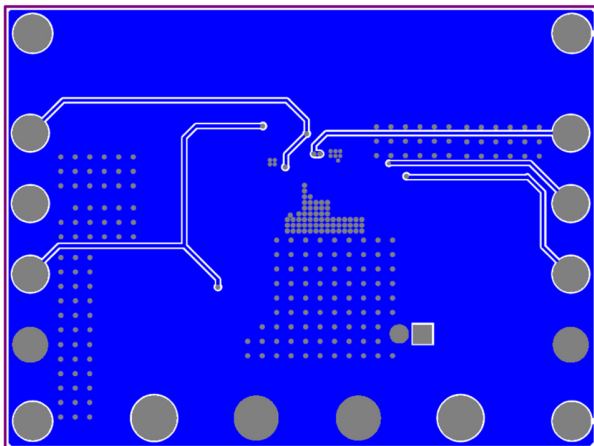

Figure 3: Bottom Layer