



# EV2329-G-00A

24V, 6.5A, Low I<sub>Q</sub>

## Step-Down Converter Evaluation Board

The Future of Analog IC Technology®

### DESCRIPTION

The EV2329-G-00A is an evaluation board for MP2329, a fully integrated high frequency synchronous rectified step-down switch mode converter. It offers super compact solution to achieve 6.5A continuous output current and 7.5A peak output current over a wide input supply range.

The MP2329 operates at high efficiency over a wide output current load rang based on MPS proprietary switching loss reduction tech and internal Low Ron Power MOSFETs. Adaptive Constant-On-Time (COT) control mode provides fast transient response and eases loop stabilization. The DC auto tune loop combined with the remote differential sense provides good load and line regulation.

Full protection features include OCP, OVP, UVP and thermal shut down.

The converter requires minimum number of external components and is available in QFN 2mmx2mm package.

### ELECTRICAL SPECIFICATION (1)

Parameter	Symbol	Value	Units
Input Voltage	V <sub>IN</sub>	8 to 24	V
Output Voltage	V <sub>OUT</sub>	3.3	V
Continuous Output Current	I <sub>OUT</sub>	6.5	A
Peak Output Current	I <sub>OUT</sub>	7.5	A

#### Notes:

1) For different Input/output voltage specs and different output capacitor/inductor may need change the application circuit parameters.

### FEATURES

- Wide 4.5V to 24V Operating Input Range
- 105µA low quiescent Current
- 6.5A Continuous Output Current
- 7.5A Peak Output Current
- Adaptive COT for Fast transient
- DC Auto Tune Loop and Remote Differential sense
- Low R<sub>DS(ON)</sub> Internal Power MOSFETs
- Proprietary Switching Loss Reduction Technique
- Power Good Indication
- Stable with POSCAP and Ceramic Cap
- Internal Soft Start
- Output Discharge
- OCP, OVP, UVP and Thermal Shutdown
- QFN-11(2mm x 2mm) Package

### APPLICATIONS

- Laptop Computer
- Tablet PC
- Networking Systems
- Server
- Distributed Power Systems

All MPS parts are lead-free, halogen free, and adhere to the RoHS directive. For MPS green status, please visit MPS website under Quality Assurance.

"MPS" and "The Future of Analog IC Technology" are Registered Trademarks of Monolithic Power Systems, Inc.

## EV2329-G-00A EVALUATION BOARD



(L x W) 64mm x 64mm

Board Number	MPS IC Number
EV2329-G-00A	MP2329GG

### Efficiency

V<sub>OUT</sub>=3.3V, L=2.2µH, DCR=12mΩ

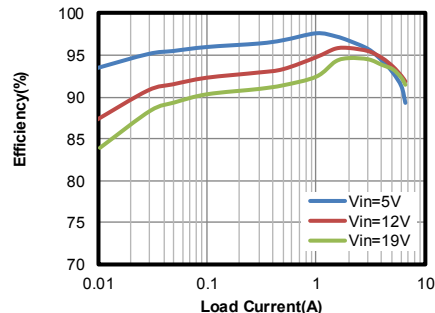

## EVALUATION BOARD SCHEMATIC (2)

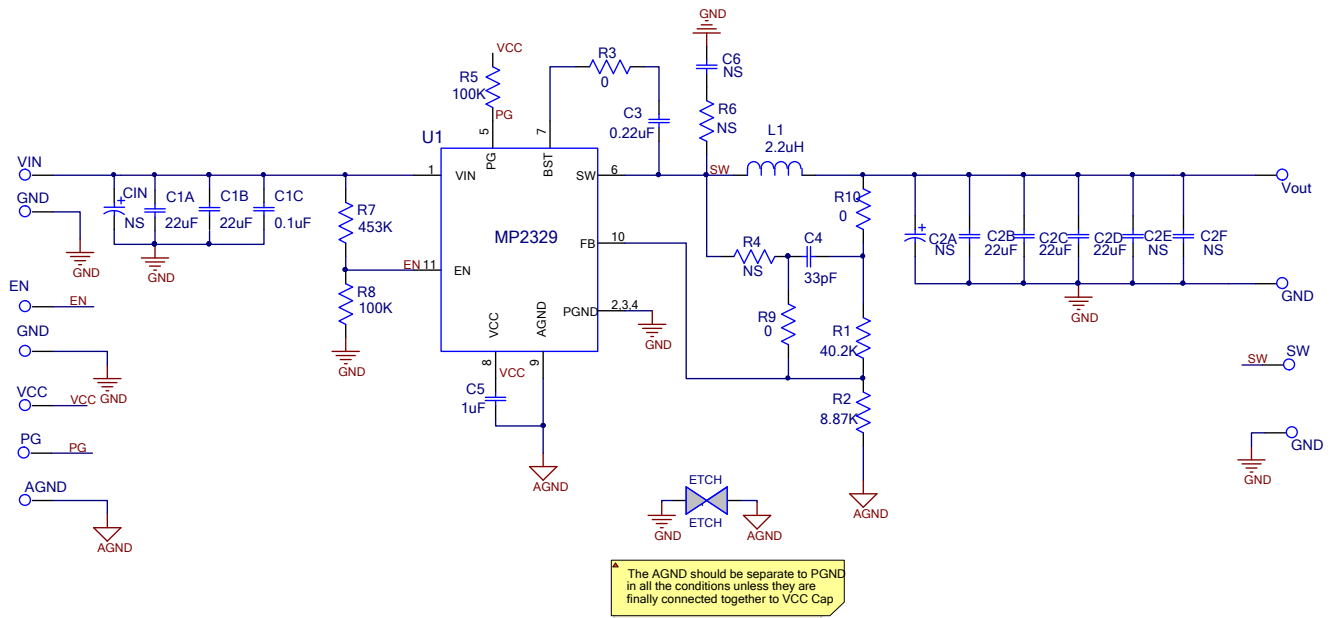

**Notes:**

- EN resistor divider sets the VIN rising threshold to 7.5V. For 5V input application, change R7 to 200K.

**EV2329-G-00A BILL OF MATERIALS**

Qty	Des	Value	Description	Package	Manufacture	Manufacture_PN
2	C1A, C1B	22 $\mu$ F	Ceramic Capacitor;25V;X5R;	1206	muRata	GRM31CR61E226KE15L
1	C1C	0.1 $\mu$ F	Ceramic Capacitor;25V;X7R;	0603	muRata	GRM188R71E104KA01D
3	C2B,C2C, C2D	22 $\mu$ F	Ceramic Capacitor;16V;X5R;	0805	muRata	GRM21BR61C226ME44L
0	C1N,C2A, C2E,C2F,C6	NS				
1	C3	0.22 $\mu$ F	Ceramic Capacitor;16V;X7R	0603	muRata	GRM188R71C224KA01D
1	C4	33pF	Ceramic Cap.,50V,C0G	0603	muRata	GRM1885C1H330JA01D
1	C5	1 $\mu$ F	Ceramic Capacitor;16V;X7R	0603	muRata	GRM188R71C105KE15D
1	R1	40.2k	Film Res,1%	0603	Yageo	RC0603FR-0740K2L
1	R2	8.87k	Film Res,1%	0603	Yageo	RC0603FR-078K87L
3	R3,R9,R10	0R	Film Res,1%	0603	Yageo	RC0603FR-070RL
0	R4,R6	NS				
2	R5,R8	100k	Film Res,1%	0603	Yageo	RC0603FR-07100KL
1	R7	453k	Film Res,1%	0603	Yageo	RC0603FR-07453KL
1	L1	2.2 $\mu$ H	Inductor, RDC=12m $\Omega$ Isat=14A	SMD	Würth	74437349022
1	U1	MP2329	Synchronous Step-Down Converter	QFN2*2	MPS	MP2329GG

## EVB TEST RESULTS

$V_{IN} = 19V$ ,  $V_{OUT} = 3.3V$ ,  $L = 2.2\mu H$ ,  $T_A = +25^\circ C$ , unless otherwise noted.

### Input/Output Ripple

$I_{OUT} = 0A$

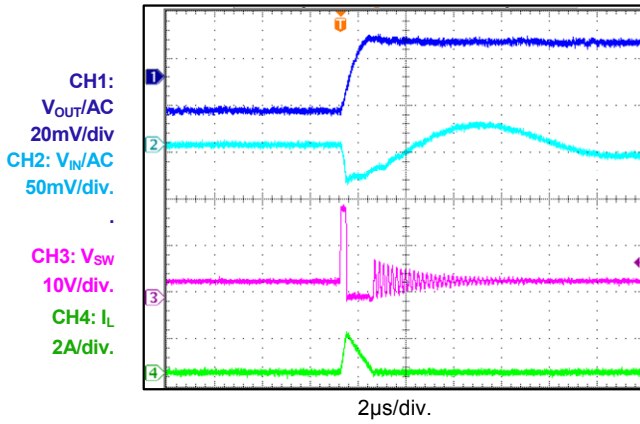

### Input/Output Ripple

$I_{OUT} = 6.5A$

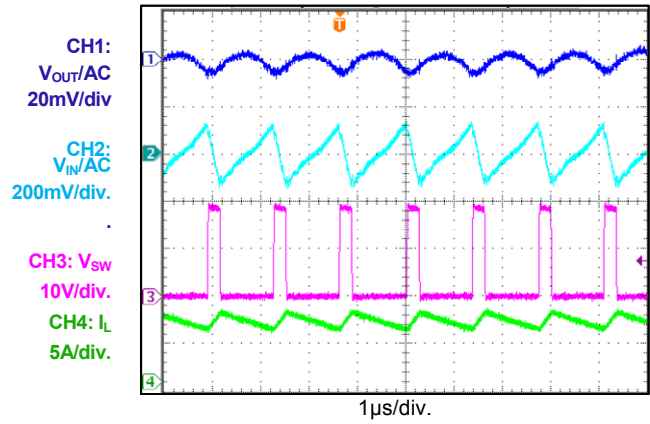

### Startup through Input Voltage

$I_{OUT} = 0A$

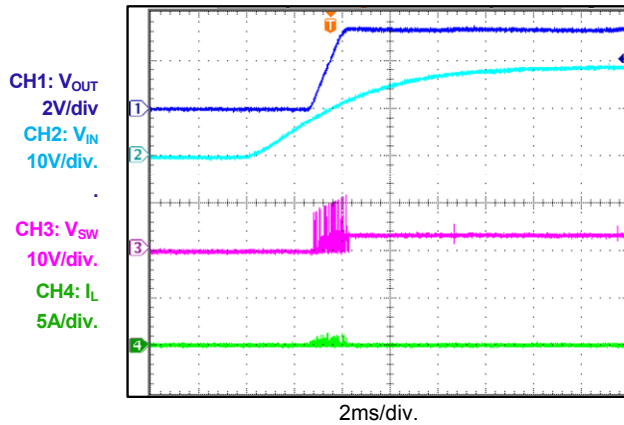

### Startup through Input Voltage

$I_{OUT} = 6.5A$

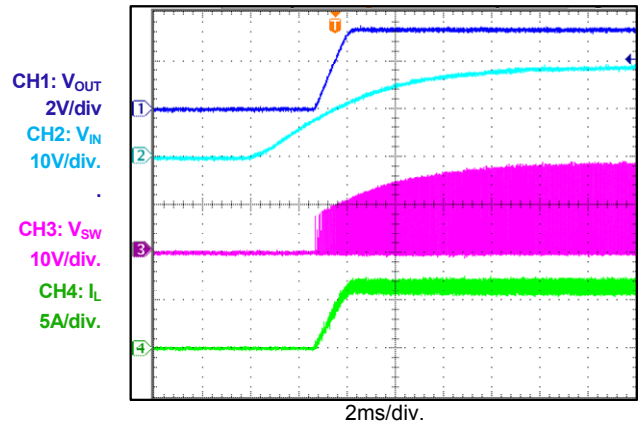

### Shutdown through Input Voltage

$I_{OUT} = 0A$

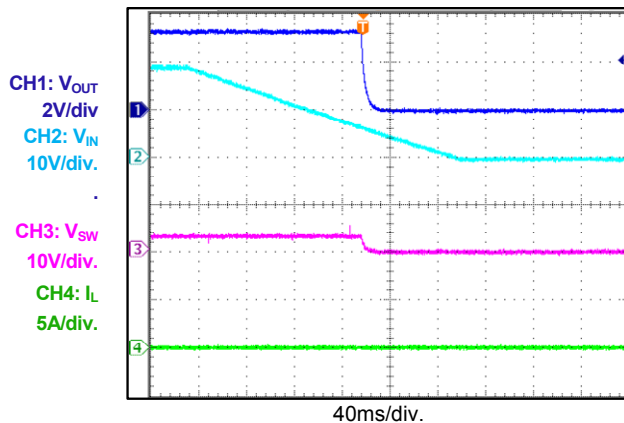

### Shutdown through Input Voltage

$I_{OUT} = 6.5A$

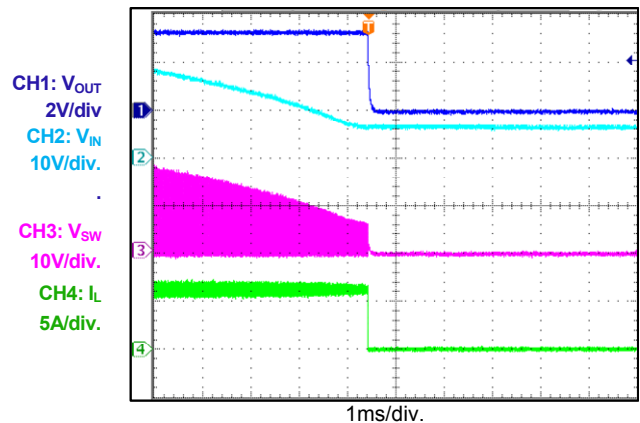

**EVB TEST RESULTS** *(continued)*
 $V_{IN} = 19V$ ,  $V_{OUT} = 3.3V$ ,  $L = 2.2\mu H$ ,  $T_A = +25^\circ C$ , unless otherwise noted.

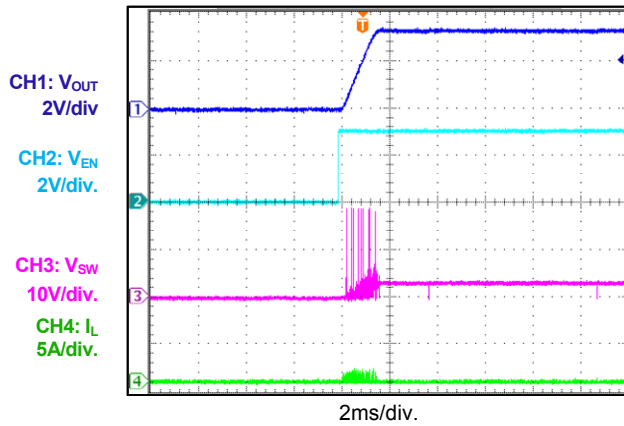
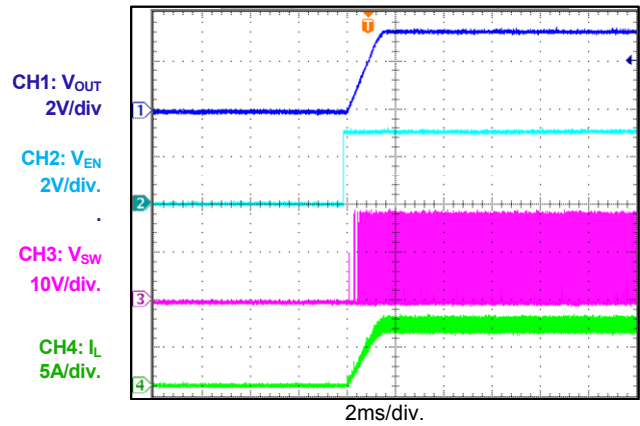
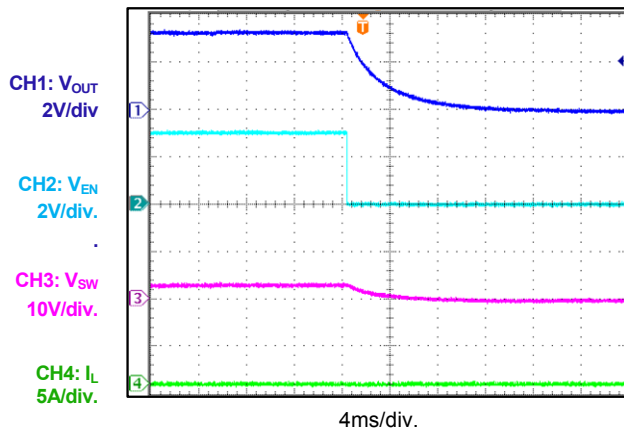
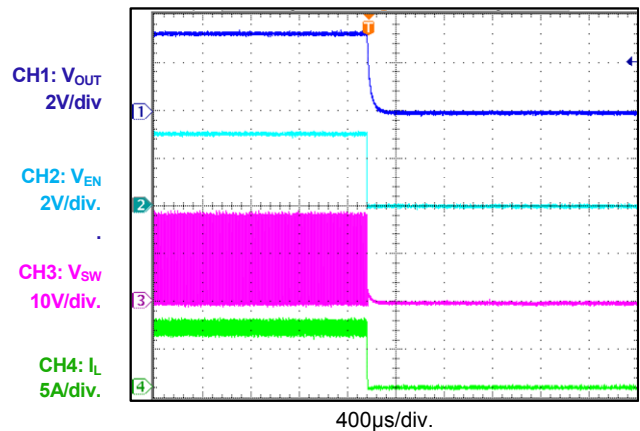
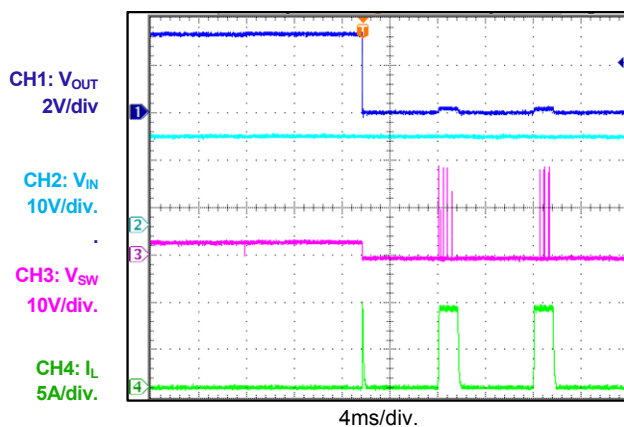
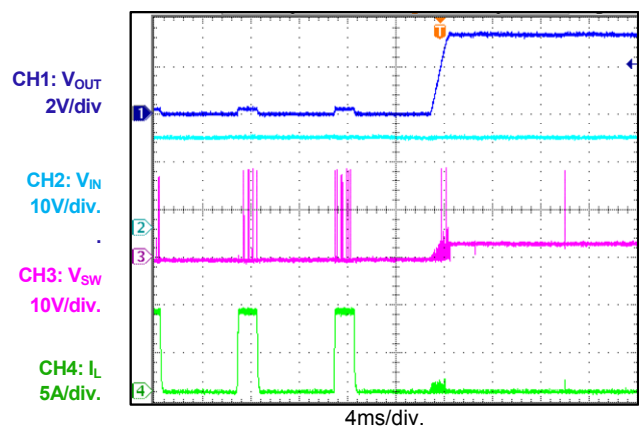
**Startup through Enable**
 $I_{OUT} = 0A$ 

**Startup through Enable**
 $I_{OUT} = 6.5A$ 

**Shutdown through Enable**
 $I_{OUT} = 0A$ 

**Shutdown through Enable**
 $I_{OUT} = 6.5A$ 

**Short Circuit Entry**

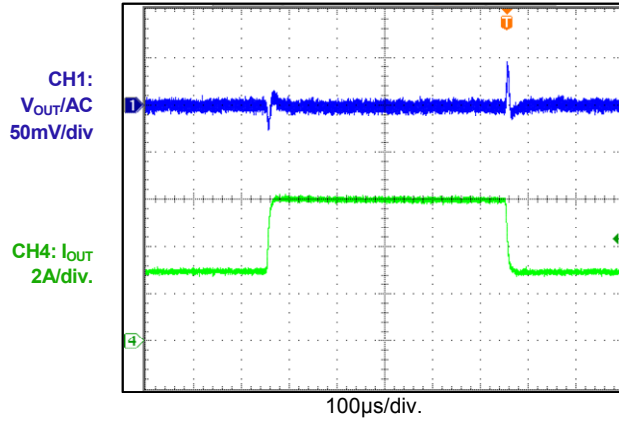
**Short Circuit Recovery**

### EVB TEST RESULTS *(continued)*

$V_{IN} = 19V$ ,  $V_{OUT} = 3.3V$ ,  $L = 2.2\mu H$ ,  $T_A = +25^\circ C$ , unless otherwise noted.

#### Load Transient

$I_{OUT} = 3A$  to  $6A$



**PRINTED CIRCUIT BOARD LAYOUT**

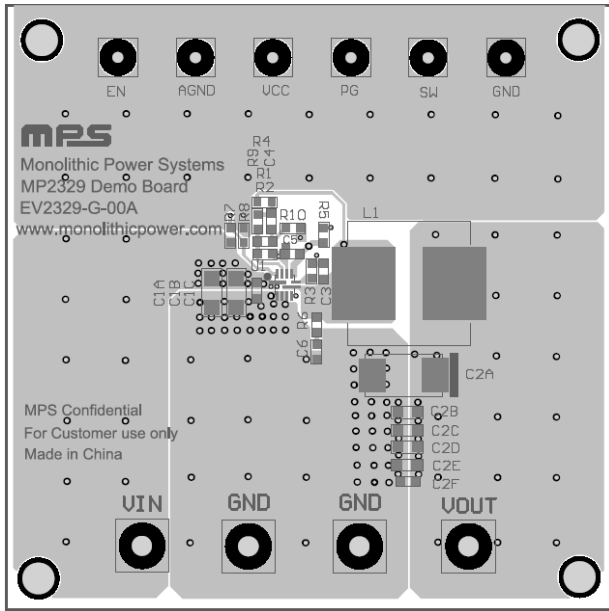

**Figure 1—Top Layer and Silk**

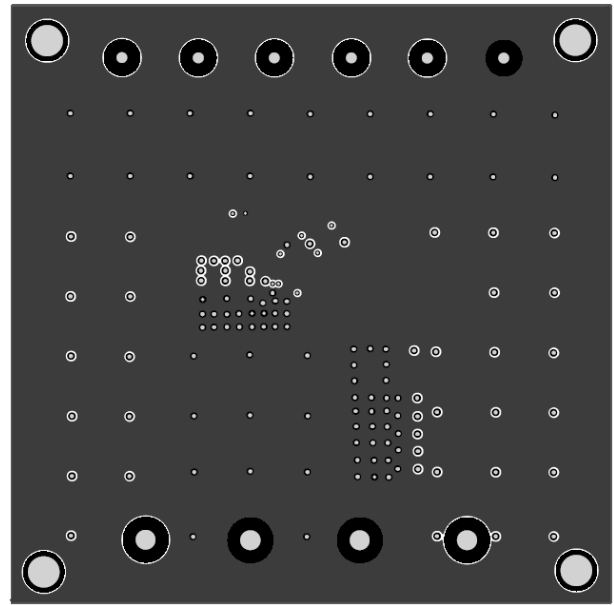

**Figure 2—Inner Layer 1**

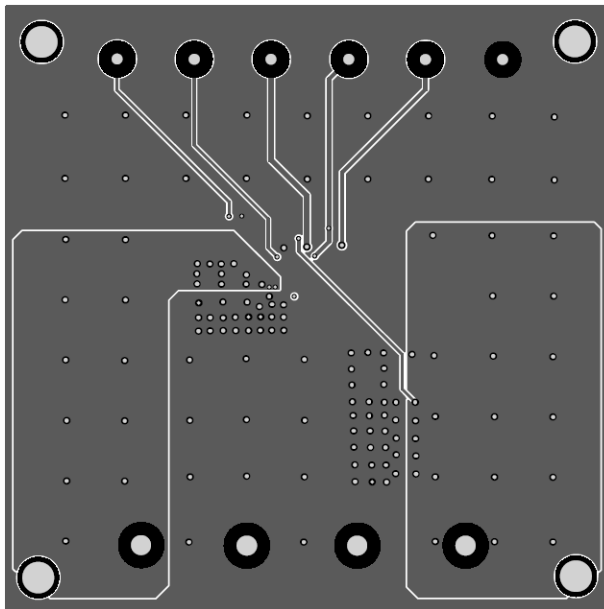

**Figure 3—Inner Layer 2**

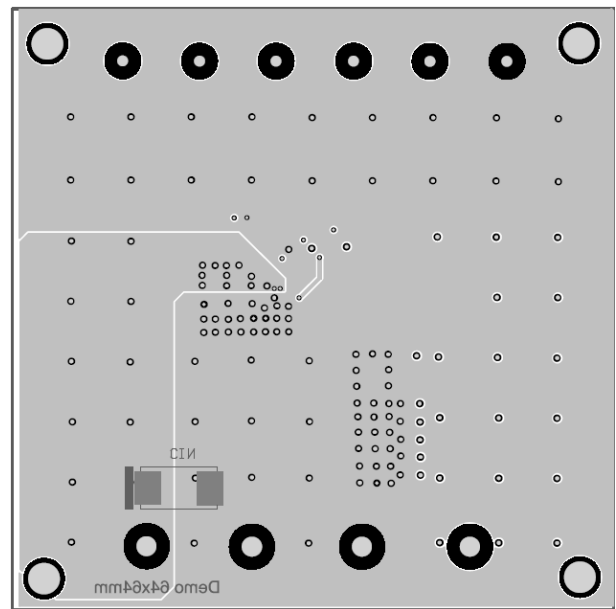

**Figure 4—Bottom Layer and Silk**