



EV2330C-TL-00A

High-Efficiency, 650kHz, 3A, 24V. Step-Down Converter Evaluation Board

DESCRIPTION

The EV2330C-TL-00A Evaluation Board is designed to demonstrate the capabilities of MPS' MP2330C, a fully-integrated high-frequency, synchronous rectified, step-down, switch-mode converter with internal power MOSFETs. It offers a very compact solution to achieve a 3A continuous output current over a wide input range, with excellent load and line regulation. The MP2330C has synchronous-mode operation for higher efficiency over the output current-load range.

Constant On-Time control operation provides very fast transient response and easy loop design as well as very tight output regulation.

Full protection features include SCP, OCP, UVP, and thermal shutdown.

The MP2330C requires a minimal number of readily-available, standard, external components and is available in a space-saving SOT583 (1.6mmx2.1mm) package.

ELECTRICAL SPECIFICATION (1)

Parameter	Symbol	Value	Units
Input Voltage	V _{IN}	19	V
Output Voltage	V _{OUT}	3.3	V
Output Current	I _{OUT}	3	A

Notes:

1) For different Input/output voltage specs and different output capacitor/inductor may need change the application circuit parameters.

FEATURES

- Wide 4.2V-to-24V Operating Input Range
- 75mΩ/40mΩ Low-R_{DS(ON)} Internal Power MOSFETs
- 200μA Low I_q
- High-Efficiency Synchronous-Mode Operation
- Fast Load Transient Response
- 650kHz Switching Frequency
- Programmable Soft-Start Time
- Forced PWM Operation
- Power Good Indication
- Over-Current Protection and Hiccup
- Pre-bias Startup
- Thermal Shutdown
- Available in a SOT583 package

APPLICATIONS

- Game Consoles
- Digital Set-Top Boxes
- Flat-Panel Television and Monitors
- General Purposes

All MPS parts are lead-free, halogen free, and adhere to the RoHS directive. For MPS green status, please visit MPS website under Quality Assurance.

"MPS" and "The Future of Analog IC Technology" are Registered Trademarks of Monolithic Power Systems, Inc.

EV2330C-TL-00A EVALUATION BOARD



(L x W x H) 63.7mm x 48.4mm x 6.4mm

Board Number	MPS IC Number
EV2330C-TL-00A	MP2330CGTL

Efficiency

V_{OUT}=3.3V, L=3.3μH, DCR=9mΩ

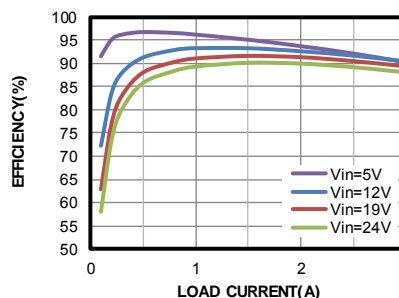

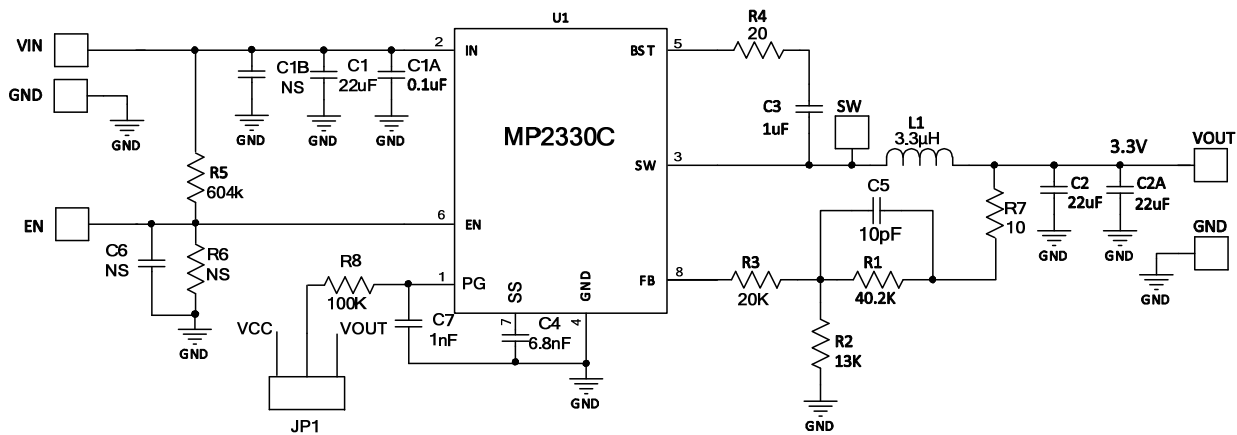
EVALUATION BOARD SCHEMATIC

EV2330C-TL-00A BILL OF MATERIALS

Qty	Ref	Value	Description	Package	Manufacturer	Part Number
1	C1	22 μ F	Ceramic Cap., 25V, X5R	0805	muRata	GRM21BR61E226ME44L
1	C1A	0.1 μ F	Ceramic Cap., 25V, X7R	0603	muRata	GRM188R71E104KA01D
2	C2,C2A	22 μ F	Ceramic Cap., 16V, X5R	0805	muRata	GRM21BR61C226ME44L
1	C3	1 μ F	Ceramic Cap., 16V, X7R	0603	muRata	GRM188R71C105KA12D
1	C4	6.8nF	Ceramic Cap., 50V, X7R	0603	muRata	GRM188R71H682KA01D
1	C5	10pF	Ceramic Cap., 50V, COG	0603	muRata	GRM1885C1H100JA01D
0	C1B,C6	NS				
1	C7	1nF	Ceramic Cap., 50V, X7R	0603	muRata	GRM188R71H102KA01D
1	R1	40.2k	Thick Film Res., 1%	0603	Yageo	RC0603FR-0740K2L
1	R2	13k	Thick Film Res., 1%	0603	Yageo	RC0603FR-0713KL
1	R3	20k	Thick Film Res., 1%	0603	Yageo	RC0603FR-0720KL
1	R4	20 Ω	Thick Film Res., 1%	0603	Yageo	RC0603FR-0720RL
1	R5	604k	Thick Film Res., 1%	0603	Yageo	RC0603FR-07604KL
0	R6	NS				
1	R7	10 Ω	Thick Film Res., 1%	0603	Yageo	RC0603JR-0710RL
1	R8	100k	Thick Film Res., 1%	0603	Yageo	RC0603FR-07100KL
1	L1	3.3 μ H	DCR=25.5mOhm, Isat=6.6A	SMD	Sunlord	WPL6530H3R3MT
1	U1	MP2330C	Synchronous Step-Down Converter	SOT583	MPS	MP2330CGTL
1	JP1	Jumper	Jumper	DIP-3	Any	

EVB TEST RESULTS

$V_{IN} = 19V$, $V_{OUT} = 3.3V$, $L = 3.3\mu H$, $T_A = +25^\circ C$, unless otherwise noted.

Input/Output Ripple

$I_{OUT} = 0A$

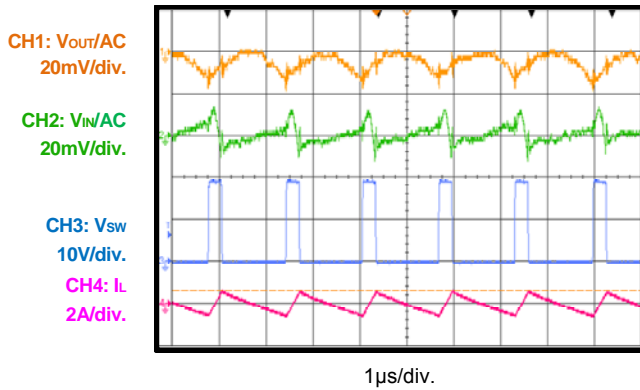

Input/Output Ripple

$I_{OUT} = 3A$

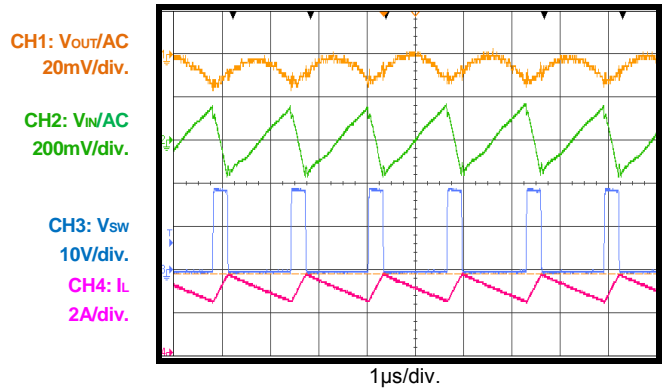

Startup through Input Voltage

$I_{OUT} = 0A$

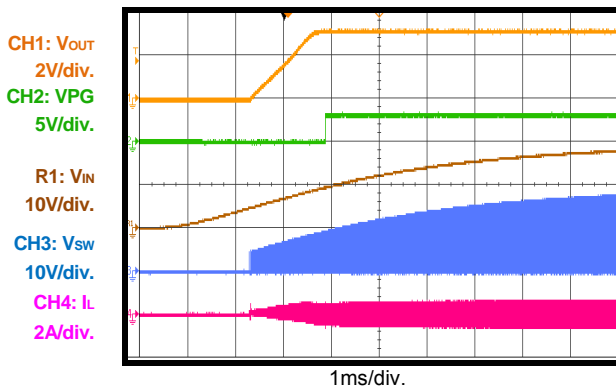

Startup through Input Voltage

$I_{OUT} = 3A$

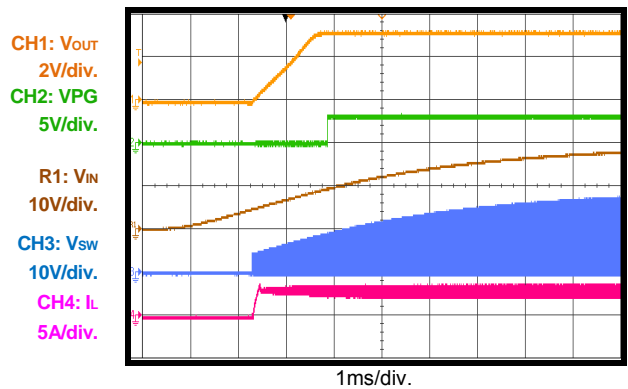

Shutdown through Input Voltage

$I_{OUT} = 0A$

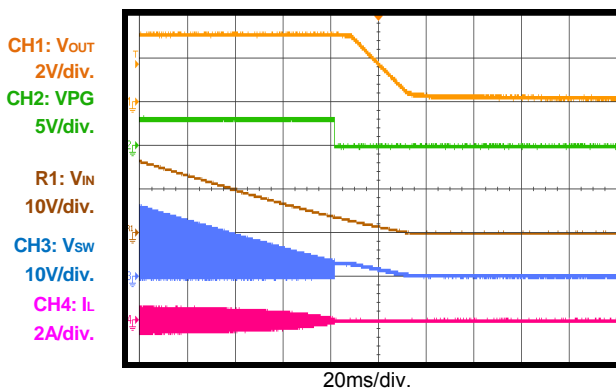

Shutdown through Input Voltage

$I_{OUT} = 3A$

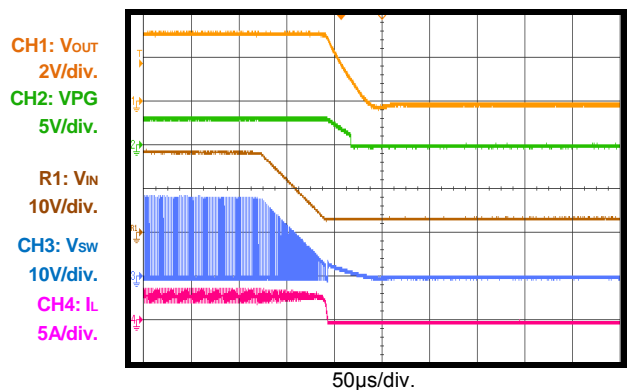

EVB TEST RESULTS (continued)
 $V_{IN} = 19V$, $V_{OUT} = 3.3V$, $L = 3.3\mu H$, $T_A = +25^\circ C$, unless otherwise noted.

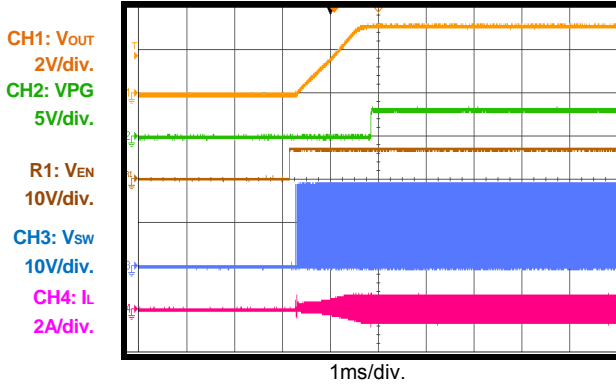
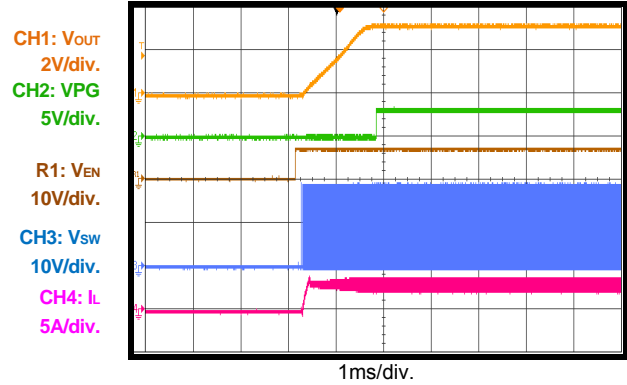
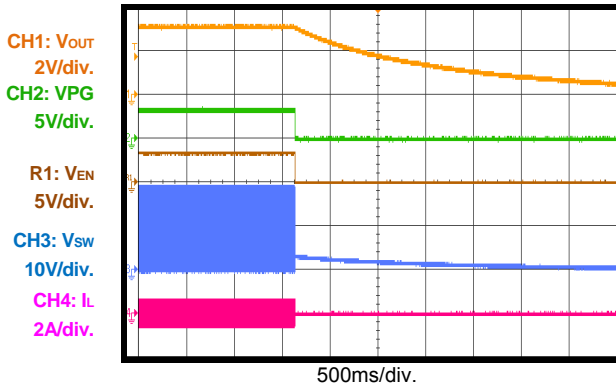
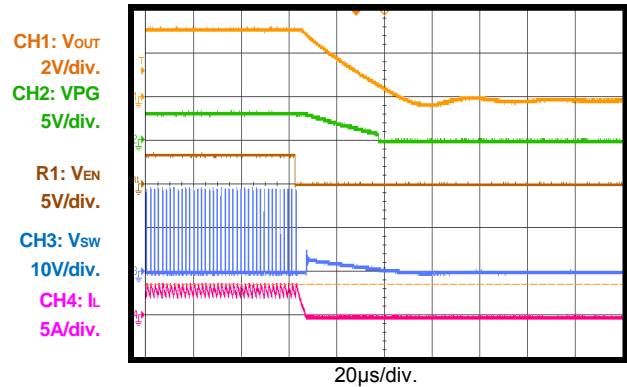
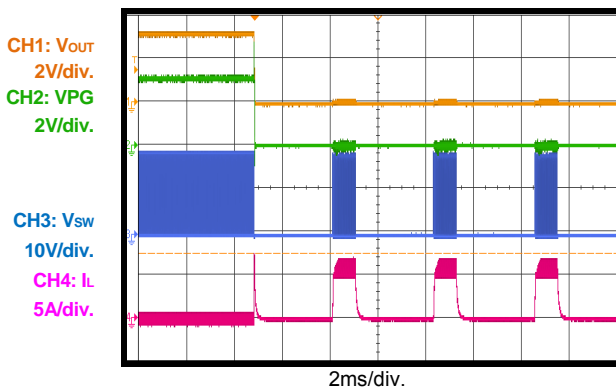
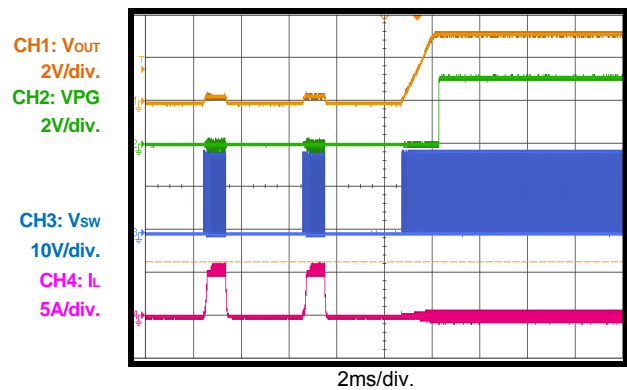
Startup through Enable
 $I_{OUT} = 0A$

Startup through Enable
 $I_{OUT} = 3A$

Shutdown through Enable
 $I_{OUT} = 0A$

Shutdown through Enable
 $I_{OUT} = 3A$

Short Circuit Entry
 $I_{OUT} = 0A$

Short Circuit Recovery
 $I_{OUT} = 0A$

EVB TEST RESULTS (continued)

$V_{IN} = 19V$, $V_{OUT} = 3.3V$, $L = 3.3\mu H$, $T_A = +25^\circ C$, unless otherwise noted.

Load Transient

$I_{OUT} = 1.5A$ to $3A$, Slew rate is $2.5A/\mu s$ by CCDH

E-load

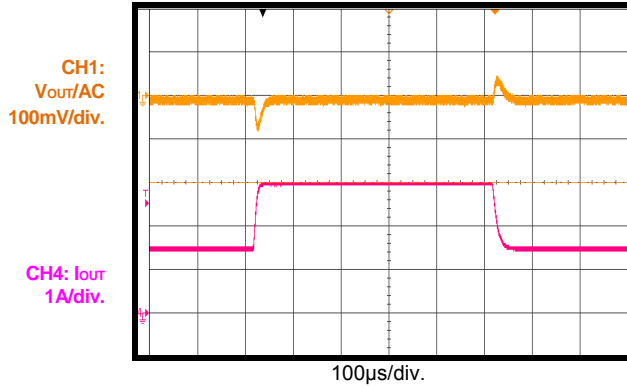

PRINTED CIRCUIT BOARD LAYOUT

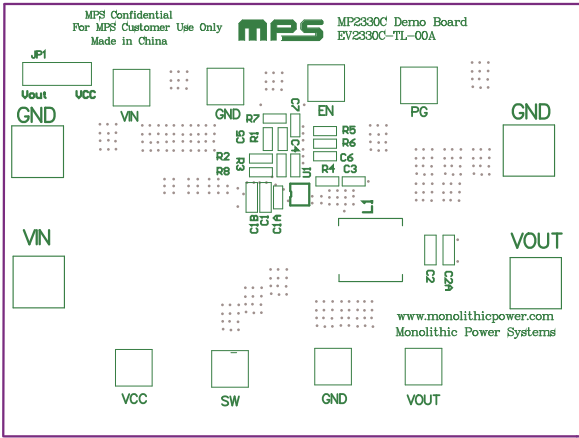

Figure 1: Top silk layer

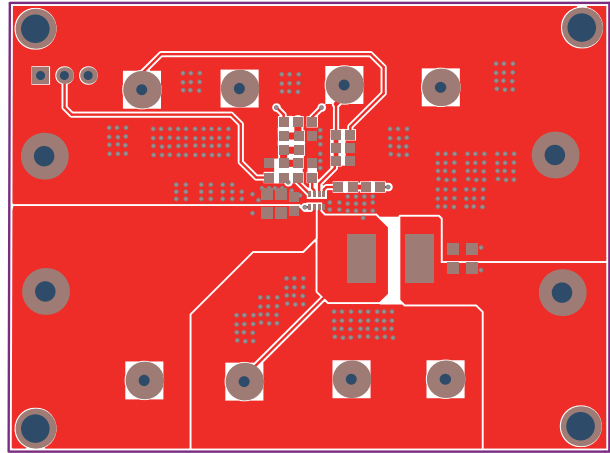

Figure 2: Top layer

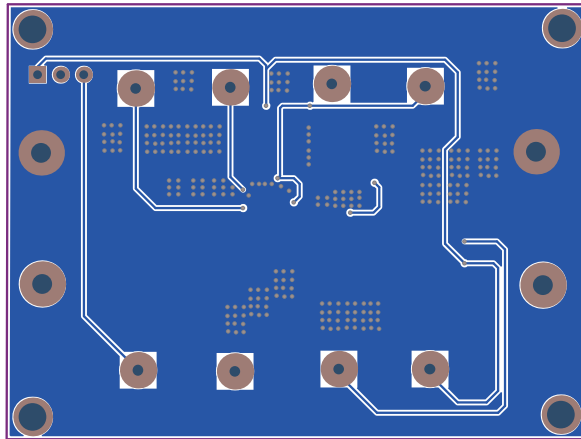

Figure 3: Bottom layer