



The Future of Analog IC Technology®

EV24833-A-N-00A

3A,55V

White LED Driver

DESCRIPTION

The EV24833-A-N-00A Evaluation Board is designed to demonstrate the capabilities of MP24833-A. The MP24833-A is a 55V, 3A, white LED driver suitable for either step-down or inverting step-up/down applications.

EV24833-A-N-00A is compatible with step-down (Buck) and inverting step-up/down (Buck-boost) applications.

- For step-down application, short “JP1”, open “JP2”, connect LED load to “LED+” and “LED-”
- ; For step-up/down application, short “JP2”, open “JP1”, connect LED load to “LED+” and “LED-”

ELECTRICAL SPECIFICATION

	Parameter	Symbol	Value	Units
Buck-boost	Input Voltage	VIN	15~25	V
	LED Voltage	VLED	3~21	V
	LED Current	ILED	1	A
Buck	Input Voltage	VIN	28~50	V
	LED Voltage	VLED	3~21	V
	LED Current	ILED	1	A

FEATURES

- 3A Maximum Output Current
- Unique Step-Up/Down Operation (Buck-Boost Mode)
- Wide 4.5V-to-55V Operating Input Range for Step-Down Applications (Buck Mode)
- 0.19Ω Internal Power MOSFET Switch
- Fixed 200kHz Switching Frequency
- Analog and PWM Dimming
- 0.198V Reference Voltage
- 6μA Shutdown Mode
- No Minimum Number of LEDs Required
- Stable with Low ESR Output Ceramic Capacitors
- Cycle-by-Cycle Over-Current Protection
- Thermal Shutdown Protection
- Open Strings Protection
- Output Short-Circuit Protection
- Available in an SOIC8EP Package

APPLICATIONS

- General LED Illumination
- LCD Backlight Panels
- Notebook Computers
- Automotive Internal Lighting
- Portable Device

All MPS parts are lead-free, halogen free, and adhere to the RoHS directive. For MPS green status, please visit MPS website under Quality Assurance. “MPS” and “The Future of Analog IC Technology” are Registered Trademarks of Monolithic Power Systems, Inc.

EV24833-A-N-00A EVALUATION BOARD

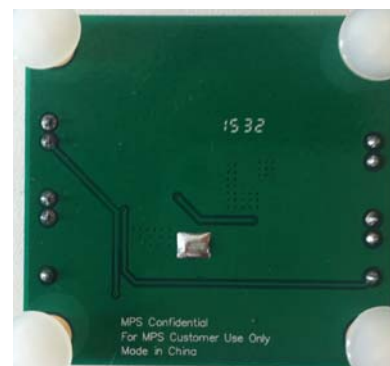

EVALUATION BOARD SCHEMATIC

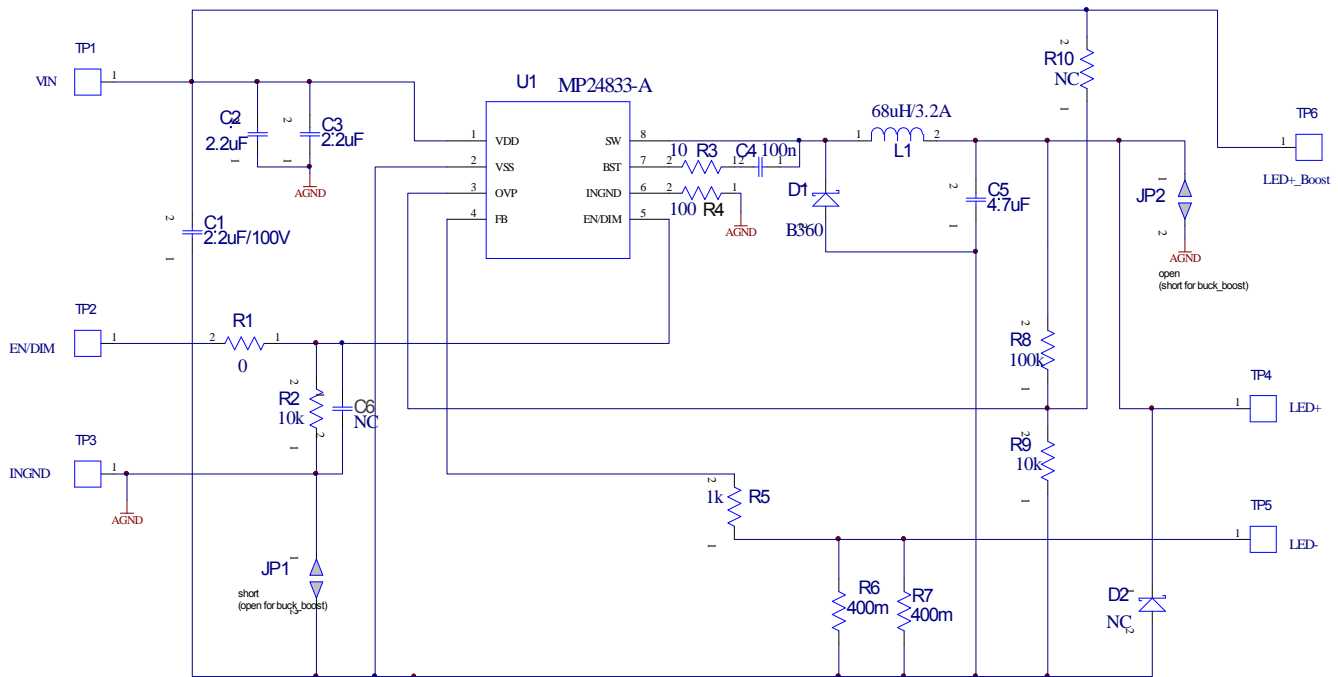

EV24833-A-N-00A BILL OF MATERIALS

Qty	Ref	Value	Description	Package	Manufacturer	Part Number
1	C1	2.2 μ F	Ceramic Capictor,100V, X7S, 1206	1206	TDK	C3216X7S2A225K
2	C2, C3	2.2 μ F	Ceramic Capictor,50V, X7R, 1206	1206	muRata	GRM31CR71H225KA8
1	C4	100nF	Ceramic Capictor,50V, X7R, 0603	0603	muRata	GRM188R71H104KA93D
1	C5	4.7 μ F	Ceramic Capictor,50V, X7R, 1206	1206	muRata	CRM32ER71H475KA88L
1	D1	B360A	Schottky Doide, 60V, 3A, SMA	SMA	Diode	B360A
1	D2	NC		SMA		
1	L1	68 μ H/3.2A	Inductor, 68uH, 88.5mOhm, 3.2A	SMD	WURTH	7447709680
1	R1	0 Ω	Film Resistor;5%	0603	Yageo	RC0603JR-070RL
1	R3	10 Ω	Film Resistor;1%	0603	Yageo	
2	R2, R9	10k Ω	Film Resistor;1%	0603	Yageo	RC0603FR-0710KL
1	R4	100 Ω	Film Resistor;1%	0805		
1	R5	1k Ω	Film Resistor;1%	0603	Ralec	RF0603-1K
2	R6, R7	400m Ω	Film Resistor;1%	1206	Yageo	
1	R8	100k Ω	Film Resistor;1%	0603	Yageo	
1	R10	NC		0603		
1	U1	MP24833-A	White LED driver	SOIC8EP	MPS	
1	JP2		Jumper	Jumper		

PRINTED CIRCUIT BOARD LAYOUT

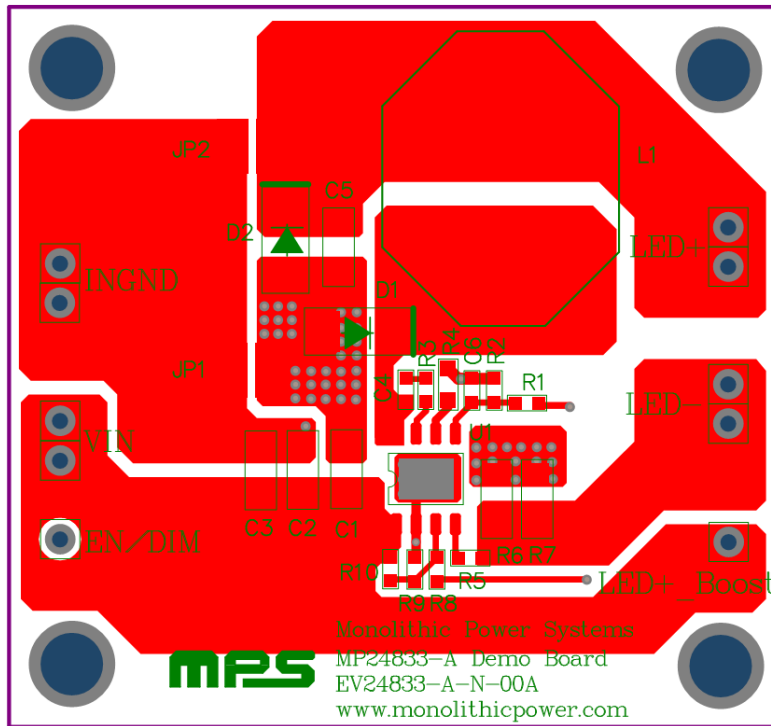

Top layer

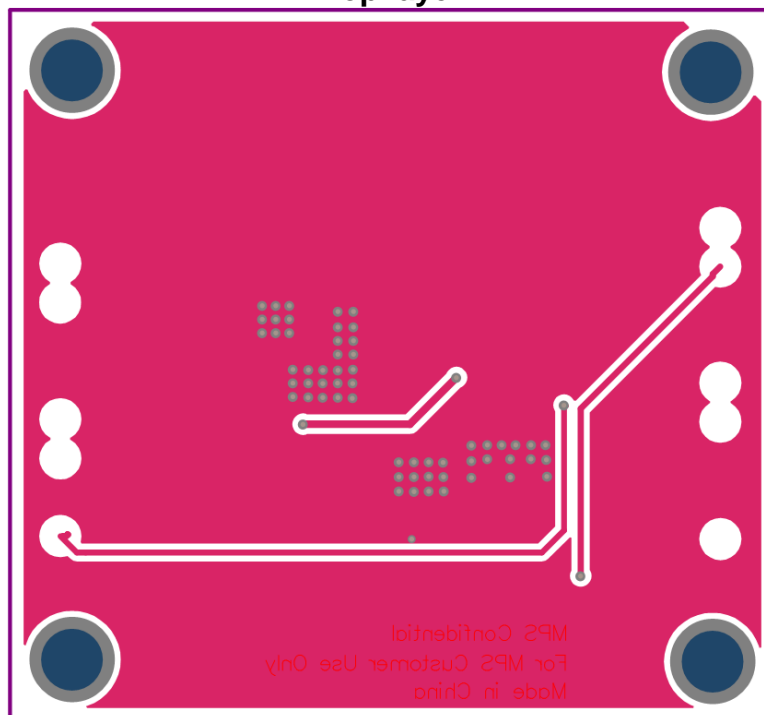

Bottom layer

EVB TEST RESULTS *(continued)*

$V_{IN} = 20V$, $I_{LED} = 1A$, 7WLEDs in series, $T_A = 25^{\circ}C$, Buck-boost Application, Refer to INGND, unless otherwise noted.

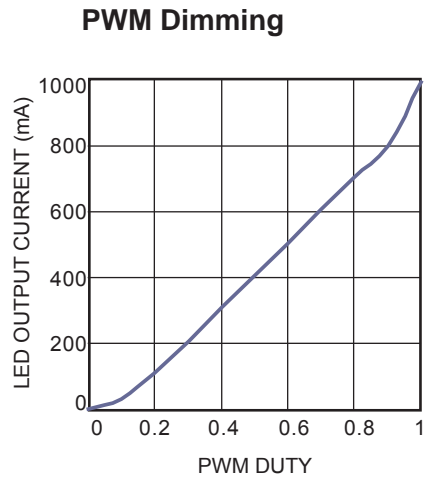
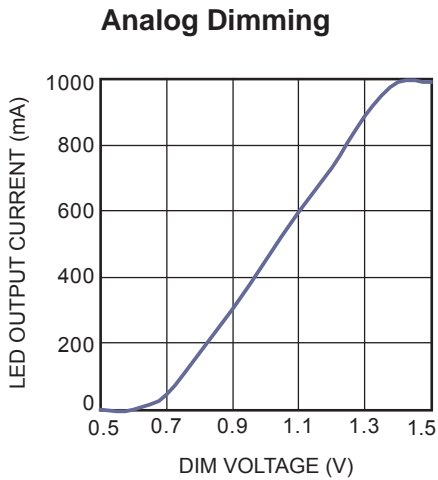
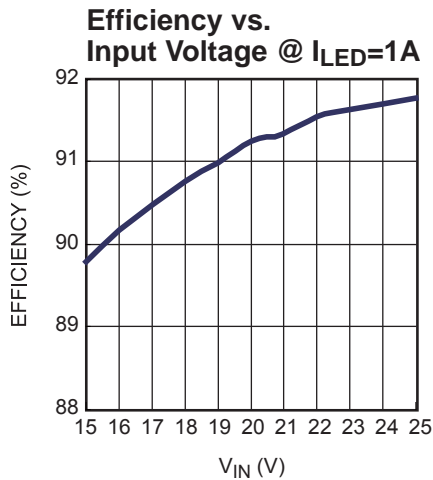

Steady State

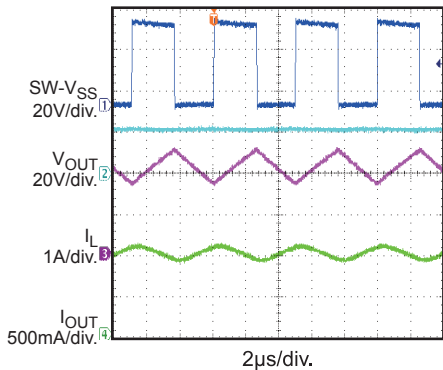

EN Start-Up

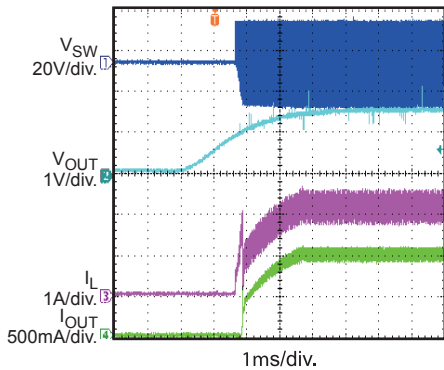

EN Shutdown

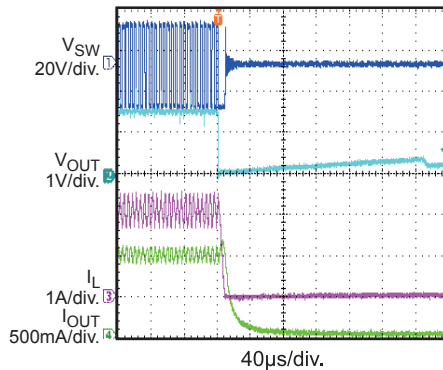

PWM Dimming

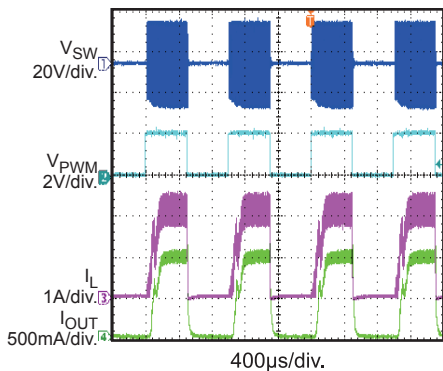

Open LED Connection

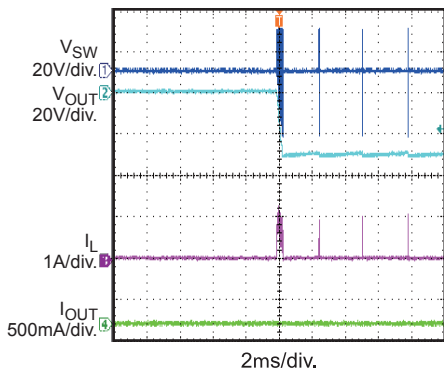

Short LED Connection

