



The Future of Analog IC Technology®

EV3331-C-00A

2A Flash LED Driver With I²C Interface

Evaluation Board

DESCRIPTION

The MP3331 is a single 2A flash LED driver with very compact package, high efficiency for high-resolution camera phones to improve image and video quality in low light environment. The device operates in 1/2/3/4MHz synchronous DCDC boost converter to provide an optimized solution for smaller PCB space and higher efficiency.

The MP3331 features standard I²C interface, single LED channel, rich protection modes and high power density and performances. It supports flash/assist light/torch/indicator/5V DC modes.

The cathode of the flash LED is referenced to GND which is better for layout to improve thermal performance. It is available in WLCSP9-1.7X1.7mm package.

ELECTRICAL SPECIFICATIONS

Parameter	Symbol	Value	Units
Input Voltage	V _{IN}	2.7-5.5	V
Output Voltage	V _{out}	<5.5	V
LEDs #		1	
LED Current	I _{LED}	Max.2	A

FEATURES

- 2.7V~5.5V input voltage
- 1/2/3/4MHz selectable switching frequency
- Switching frequency fold-back function
- 400kHz I²C compatible interface
- Standby/Flash/Assist/Torch/Indicator/5V DC mode

Flash Mode:

Up to 2A programmable current with +/-7% accuracy

Assist/Torch Mode:

Up to 508mA programmable current with +/-7% accuracy

Indicator Mode:

Work in 31.5kHz PWM dimming mode with 2/16, 3/16, 4/16, 5/16 duty cycle

5V DC Mode: Fixed 5V Output Voltage

- External Torch/Strobe Pin
- Low battery voltage protection
- Pre-flash for auto detect load condition
- LED short/open protection
- VOUT-GND short protection
- Over voltage protection
- Input to output disconnection protection
- Over temperature protection
- Input under voltage lockout protection
- Thermal protection
- Available in WLCSP9-1.7X1.7mm

APPLICATIONS

- Displays Camera Phone LED Flash
- Tablets
- Digital Still Camera

All MPS parts are lead-free, halogen free, and adhere to the RoHS directive. For MPS green status, please visit MPS website under Quality Assurance. "MPS" and "The Future of Analog IC Technology" are Registered Trademarks of Monolithic Power Systems, Inc.

EV3331-C-00A EVALUATION BOARD

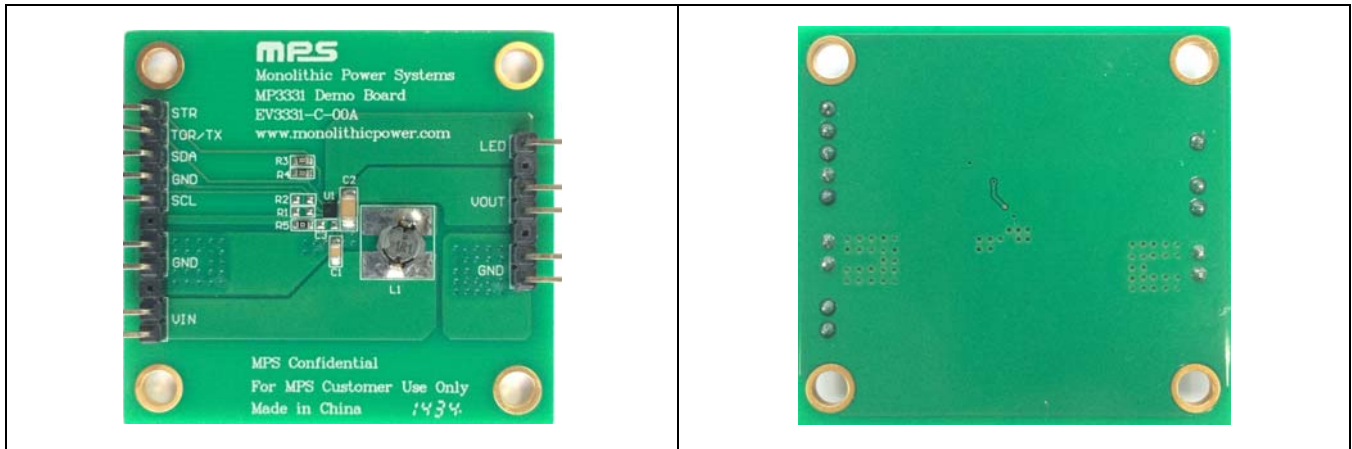

(L x W x H) 5.0cm x 4.6cm x 0.46cm

Board Number	MPS IC Number
EV3331-C-00A	MP3331GC

EVALUATION BOARD SCHEMATIC

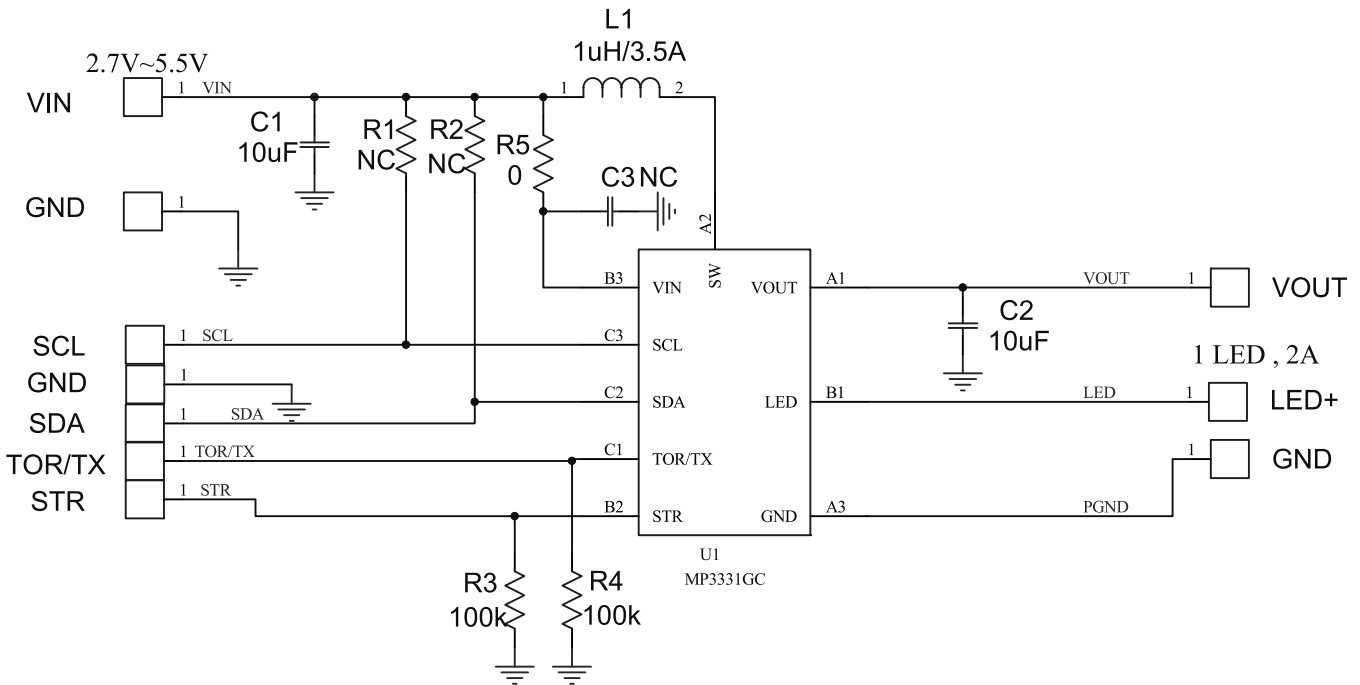

EV3331-C-00A BILL OF MATERIALS

Qty	Ref	Value	Description	Package	Manufacturer	Part Number
1	C1	10µF	Ceramic Capacitor; 10V;X5R;0805;		muRata	GRM21BR61A106KE19L
1	C2	10µF	'Ceramic Capacitor; 10V;X7R;1206;		muRata	GRM31CR71C106KAC7L
1	C3	NC	CAP/0603			
1	L1	1.1µH /3.46A	Inductor;1.1uH;20m;3.46A		TOKO	D53LC-#A915AY-1R1M
2	R1, R2	NC	RES/0603			
2	R3, R4	100k	Resistor;5%;;		Yageo	RC0603JR-07100RL
1	R5	0	Film Resistor;5%;		Yageo	RC0603JR-070RL
1	TP1	VIN	TP			
2	TP2, TP9	GND	TP			
1	TP3	SDA	TP			
1	TP4	GND	TP			
1	TP5	SCL	TP			
1	TP6	STR	TP			
1	TP7	TOR/TX	TP			
1	TP8	LED+	TP			
1	TP10	VOUT	TP			
1	U1		WLCSP9/1.65X1.65mm		MPS	

EVB TEST RESULTS

Performance waveforms are tested on the evaluation board.

V_{IN} = 3.3V, 1*LEDs, FL_TIM=100ms, L = 1μH, T_A = 25°C, unless otherwise noted.

Torch/Assist Mode

I_{LED} = 500mA

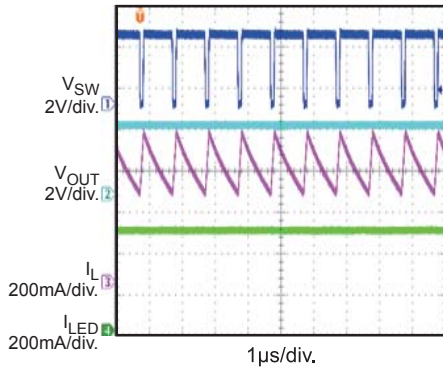

Indicator Mode

Duty=2/16

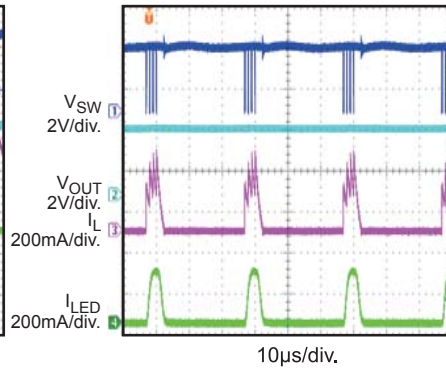

Indicator Mode

Duty=5/16

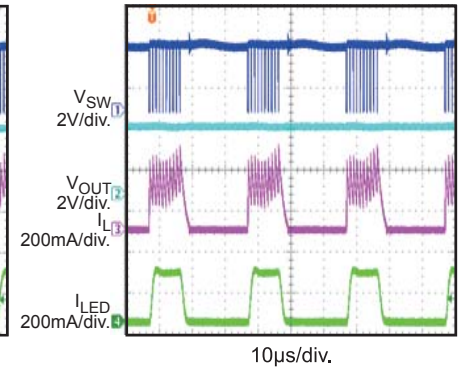

Flash Mode

Hardware and Level Sensitive Mode

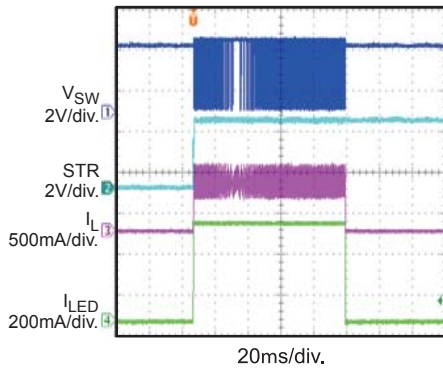

Flash Mode

Hardware and Edge Sensitive Mode

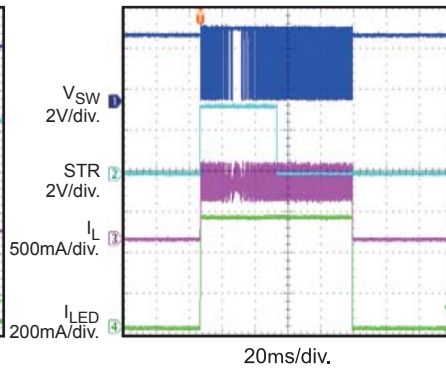

Flash Mode

Software and Edge Sensitive Mode

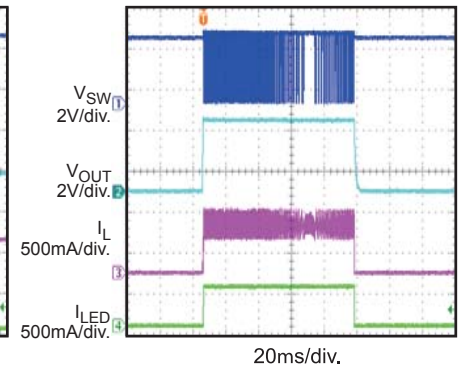

LED Enable

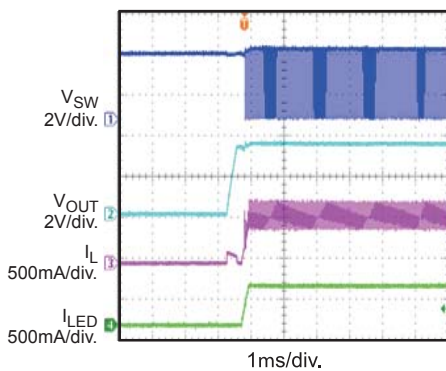

EVB TEST RESULTS (continued)

Performance waveforms are tested on the evaluation board.

VIN = 3.3V, 1*LEDs, FL_TIM=100ms, L = 1μH, TA = 25°C, unless otherwise noted.

Torch to Flash Mode

I_{TOR}=500mA, I_{FL}=1A

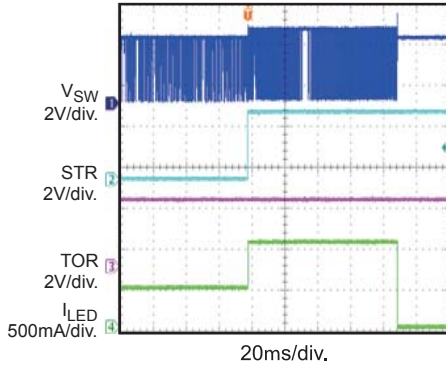

Assist to Flash Mode

I_{TOR}=500mA, I_{FL}=1A

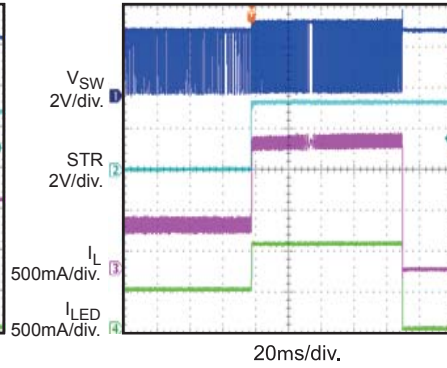

Flash Mode

TX Pin with 3Hz PWM Input

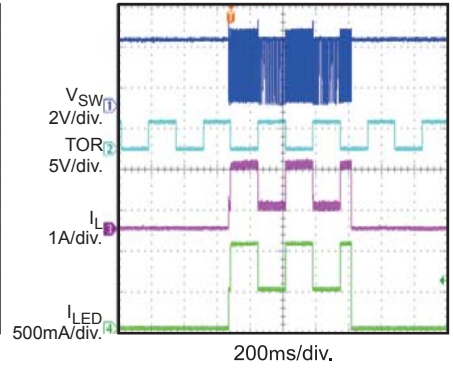

LED-GND Short Protection

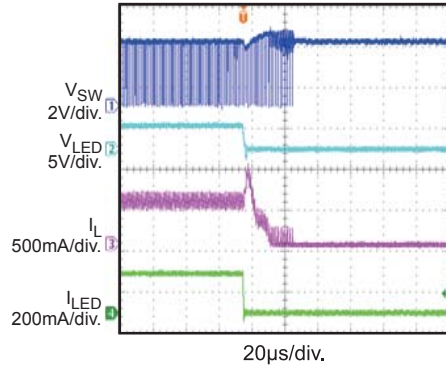

LED Open Protection

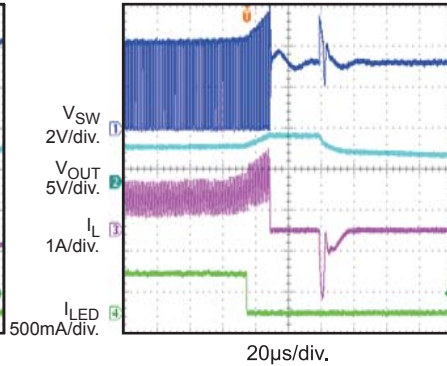

VOUT-GND Pin Short Protection

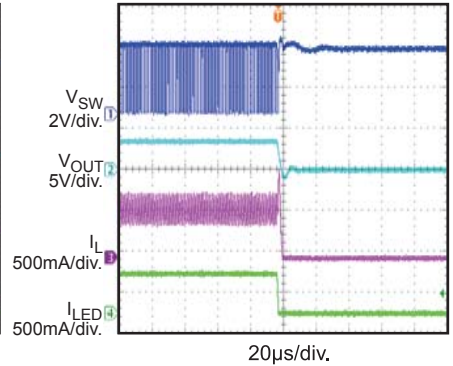

Junction Over-Temperature Protection

In Flash Mode, T_J>130°C

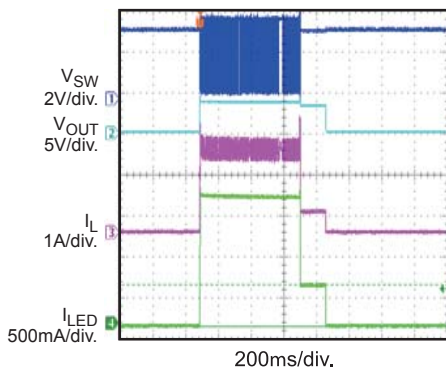

PRINTED CIRCUIT BOARD LAYOUT

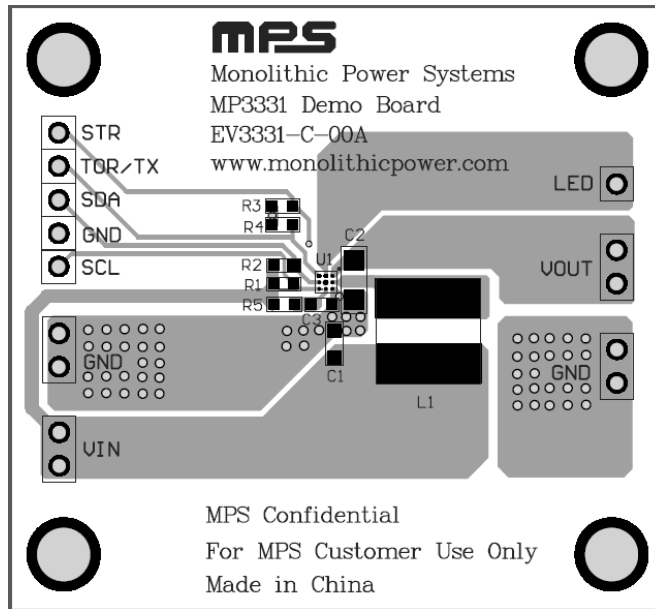

Figure 1—Top Layer

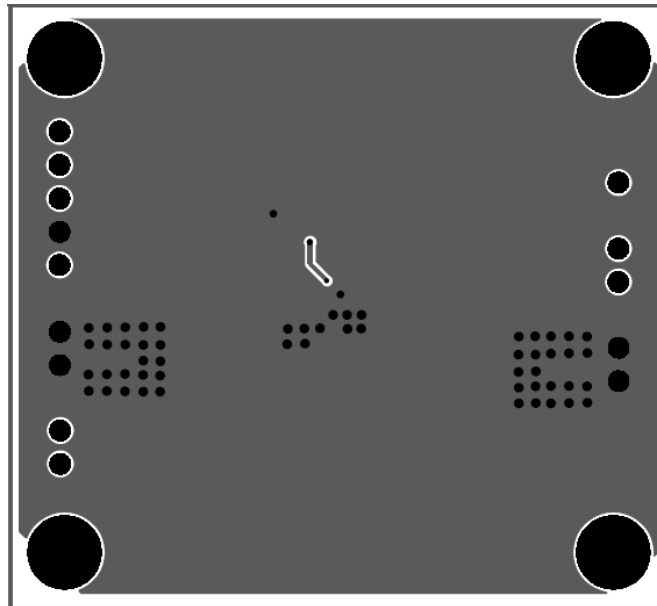

Figure 2—Bottom Layer