



The Future of Analog IC Technology®

EV3336-C-00A

Dual-Channel Flash LED Driver With 2A/Ch and I²C Interface Evaluation Board

DESCRIPTION

The MP3336 is a dual-channel and high-power flash LED driver with very compact package. It can drive up to 2A in flash mode for each LED. It is usually applied for camera phones to improve image and video quality in low light environment. The device operates in 1/2/3/4MHz synchronous, current-mode PWM boost converter to regulate the LED current with two high current source. The MP3336 provides an optimized solution for smaller PCB space and higher efficiency.

The MP3336 features standard I²C interface, dual LED channels, rich protection modes and high power density and performances. It supports flash/assist/torch/indicator/5V DC modes.

The cathodes of the dual flash LED are referenced to GND, which is better for layout to improve thermal performance. It is available in WLCSP20-1.6X2.0mm package.

ELECTRICAL SPECIFICATIONS

Parameter	Symbol	Value	Units
Input Voltage	V _{IN}	2.7-5.5	V
Output Voltage	V _{out}	<5.5	V
LEDs #		2	
LED Current/Ch	I _{LED}	Max.2	A

FEATURES

- 2.7V~5.5V Input Voltage
- 1/2/3/4MHz Selectable Max Switching Frequency
- Switching Frequency Fold-Back Function
- 400kHz I²C Compatible Interface
- Standby/Flash/Assist/Torch/Indicator/5V DC Modes

Flash Mode:

Up to 2A/Ch Programmable Current with +/-7% Accuracy for Each LED, 7.84mA/Step

Assist/Torch Mode:

Up to 319mA/Ch Programmable Current with +/-7% Accuracy for Each LED, 1.25mA/Step

Indicator Mode:

Work In 31.5kHz PWM Dimming Mode With 2/16, 3/16, 4/16, 5/16 Duty Cycle

Used for Blinking and 128/256/512ms Selectable Blinking Time

5V DC Mode:

Output Constant 5V DC Voltage

- 1A to 4.2A Programmable Input DC Current Limit Protection
- External Torch/Strobe/TX Pin
- LED Forward Voltage Balance to Improve Efficiency
- VIN to VOUT Disconnection Function
- Low Battery Voltage Protection
- LED Short/Open Protection
- VOUT-GND Short Protection
- Over Voltage Protection
- Over Temperature Protection
- Input Under Voltage Lockout Protection
- Available In WLCSP20-1.6X2.0mm

APPLICATIONS

- Smart Phone Flash LED Application
- Cameras for Tablet
- Digital Still Camera

All MPS parts are lead-free, halogen free, and adhere to the RoHS directive. For MPS green status, please visit MPS website under Quality Assurance.

"MPS" and "The Future of Analog IC Technology" are Registered Trademarks of Monolithic Power Systems, Inc.

EV3336-C-00A EVALUATION BOARD

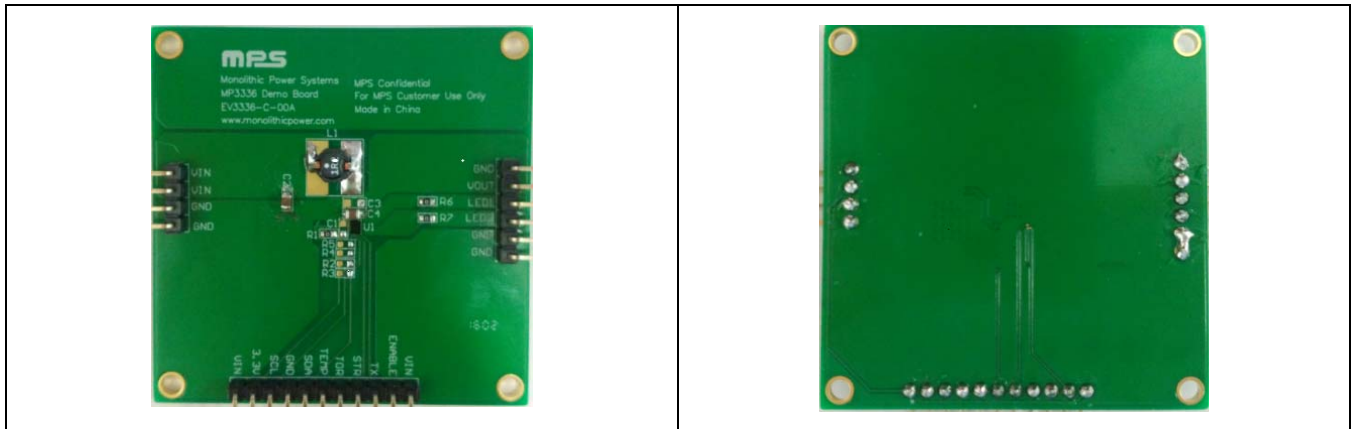

(L x W x H) 5.5cm x 5.5cm x 1cm

Board Number	MPS IC Number
EV3336-C-00A	MP3336GC

EVALUATION BOARD SCHEMATIC

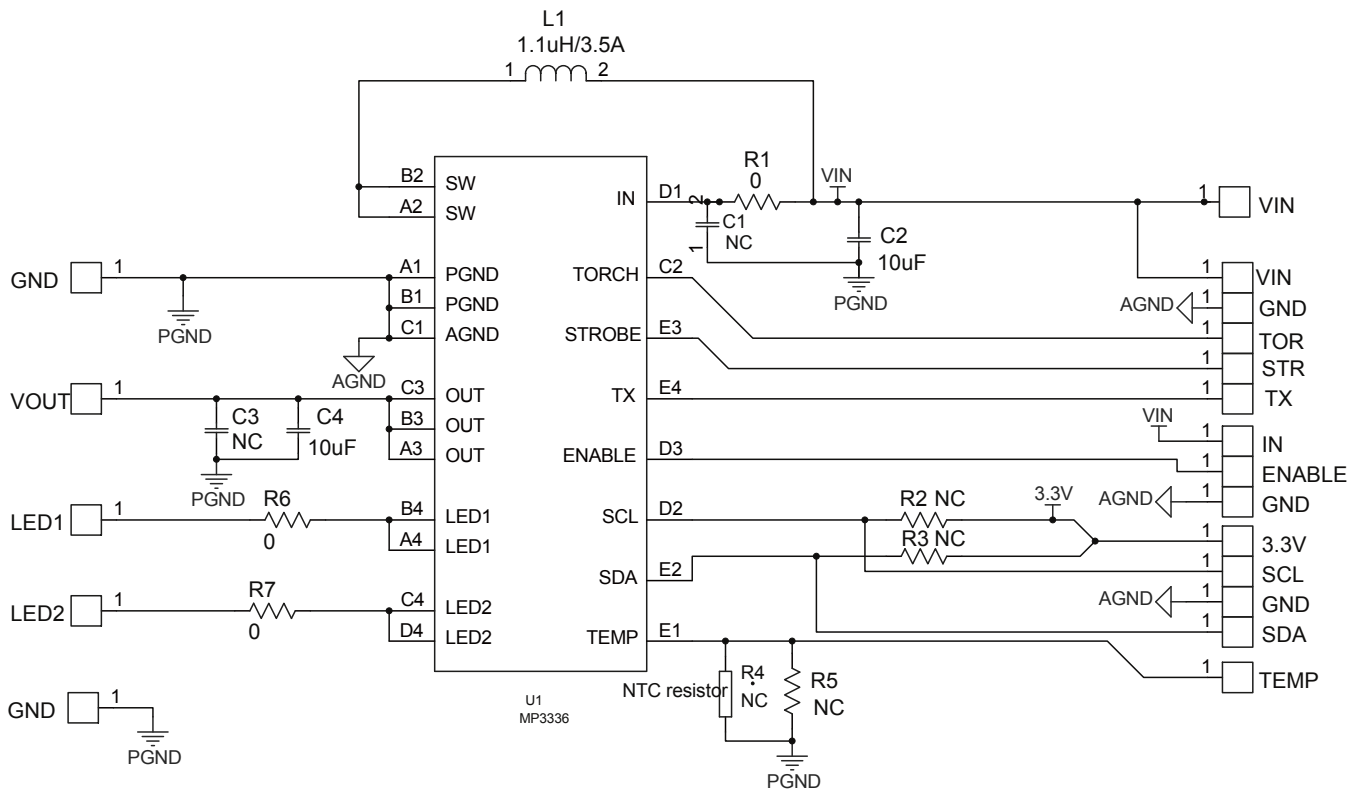

EV3336-C-00A BILL OF MATERIALS

Item	Ref	Value	Description	Footprint	Manufacturer	Manufacturer P/N
1	C1	NC		0603		
1	C2,C4	10 μ F	ceramic capacitor,10V,X5R	0805	muRata	GRM21BR61A106KE19L
2	C3	NC		0805		
1	R1,R6,R7	0	res,1%	0603	Yageo	RC0603FR-070RL
1	R2,R3,R4,R5	NC		0603		
1	L1	1.1 μ H	1.1uA, 20m,3.46A		TDK	D53LC-#A915AY-1R1M
1	U1		MP3336	CSP20 1.6*2mm	MPS	MP3336

EVB TEST RESULTS

Performance waveforms are tested on the evaluation board.

$V_{IN} = 3.6V$, $L = 1.1\mu H$, $I_{1/2_TOR} = 300mA$, $I_{1/2_FL} = 400mA$, $I_{1/2_TX} = 400mA$, $FL_TIM = 200ms$, 2 Channel. Unless otherwise noted.

Torch/Assist Mode

LED_EN Bit Enable

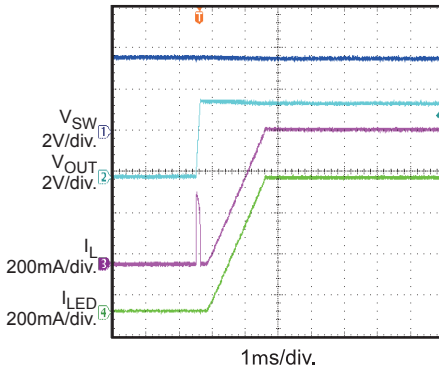

Torch/Assist Mode

LED_EN Bit Disable

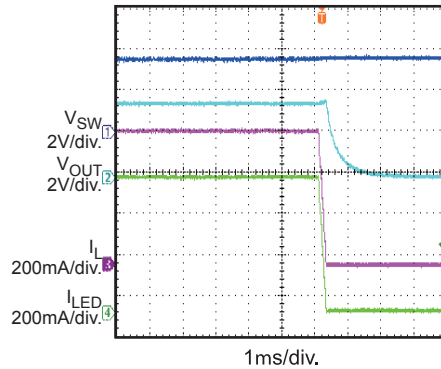

Indicator Mode

$I_{LED} \text{ Duty} = 5/16$,
 $I_{LED_AMPLITUDE/Ch} = 100mA$

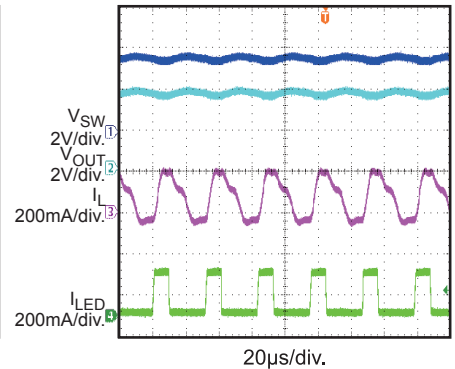

Blinking Mode

Blinking Time = 128ms

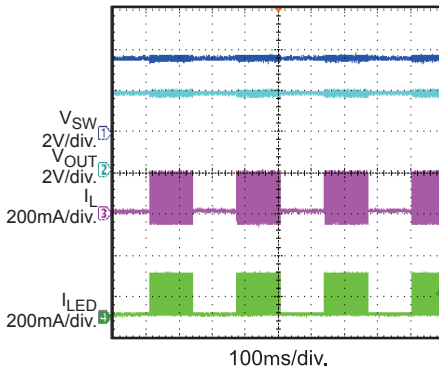

Flash Mode

with Level Trigger Way

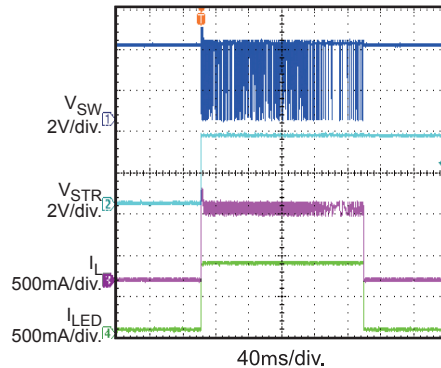

Flash Mode

with Edge Trigger Way

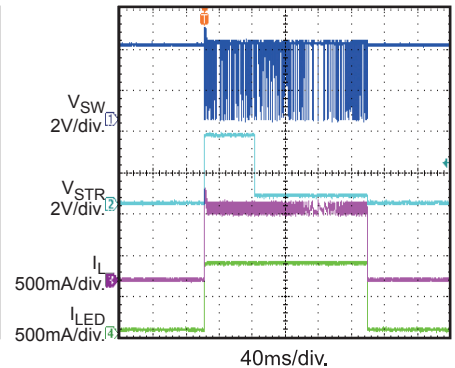

Flash Mode

$FL_TIM = 1600ms$, $I_{1_FL} = 2A$,
 $LED2_EN = 0$

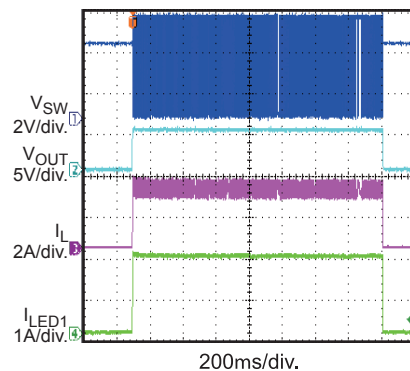

Flash Mode

TX pin with 2Hz, 50% pulse,
 $I_{1/2_FL} = 1A$

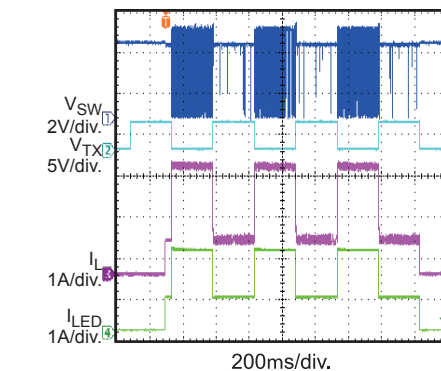

Torch/Assist Mode

to Flash Mode
 $I_{1/2_TOR} = 120mA$

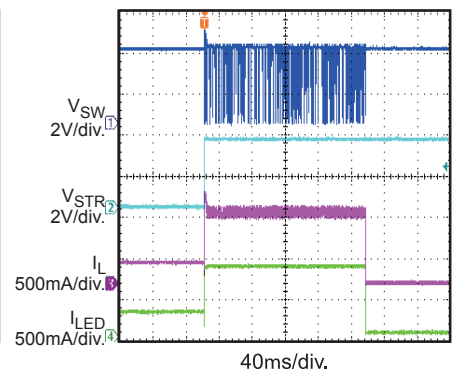

EVB TEST RESULTS

Performance waveforms are tested on the evaluation board.

V_{IN} = 3.6V, L = 1.1μH, I_{1/2_TOR} = 300mA, I_{1/2_FL} = 400mA, I_{1/2_TX} = 400mA, FL_TIM = 200ms, 2 Channel. Unless otherwise noted.

Load Balance

Set BAL_ON Bit from 0 to 1

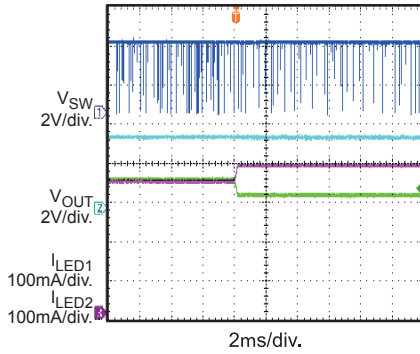

5V_DC Mode

V_{OUT} to GND with 75Ω Resistor

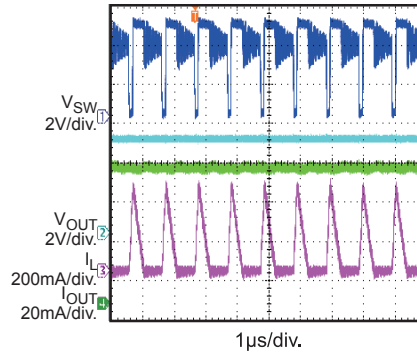

Short LED to GND Protection

Short One Channel when Working

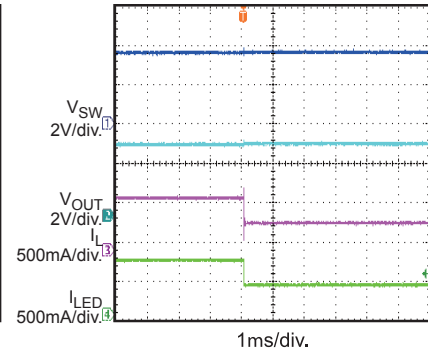

Open LED Protection

Open one Channel when Working

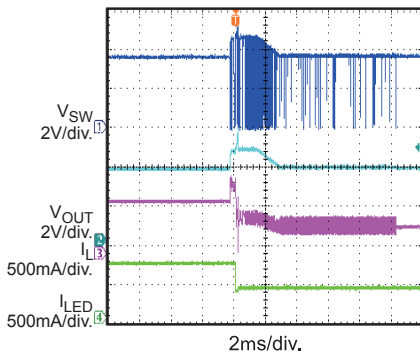

V_{OUT} to GND Short Protection

when Working

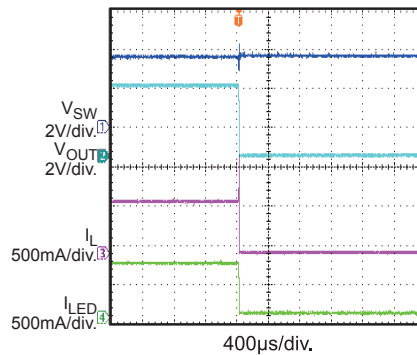

Thermal Protection

Flash Mode, Set LED_OTAD=1, I_{1/2_FL} = 600mA, FL_TIM = 1600ms

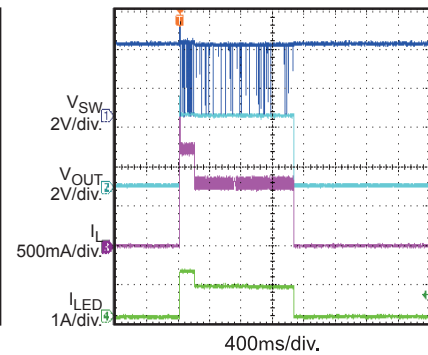

Thermal Protection

Assist Mode, Set LED_OTAD=0

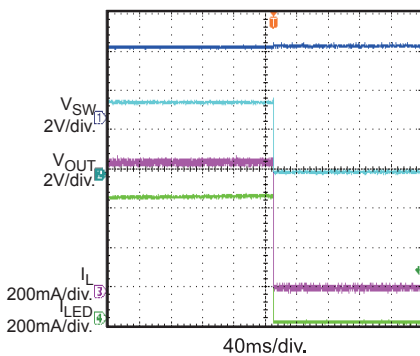

NTC Detection

Set NTC_WD = 0.88V, Set LED_T_SD = 1

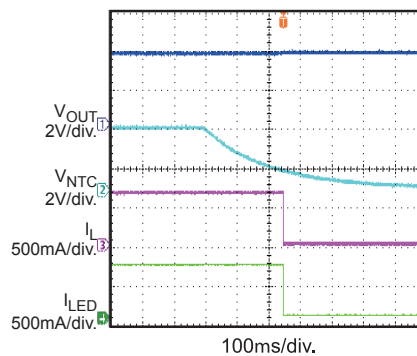

PRINTED CIRCUIT BOARD LAYOUT

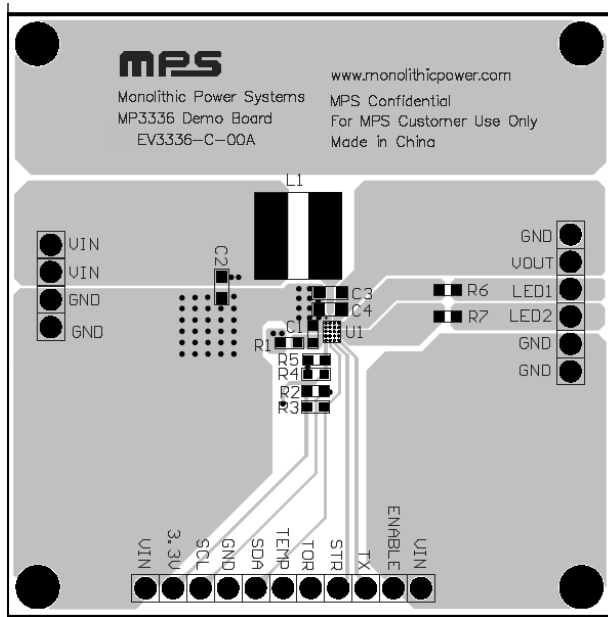

Figure 1—Top Layer

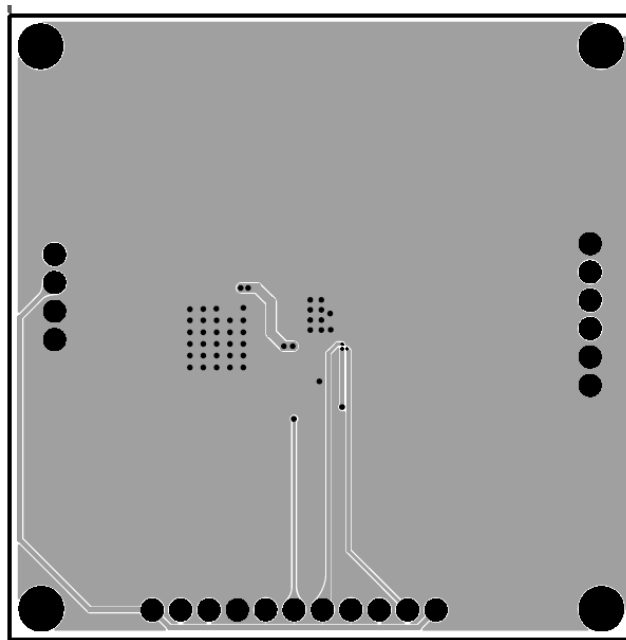

Figure 2—Bottom Layer