

DESCRIPTION

EV3910A-S-00A Evaluation Board is designed to demonstrate the capabilities of MP3910A. MP3910A is a Peak Current Mode PWM controller that can drive an external MOSFET capable of handling >10A current. It has a typical operational current of 400µA and can accommodate flyback, boost for nonisolated and isolated applications.

While designed for Boost applications, the 1A gate driver minimizes the power loss of the external MOSFET while allowing the use of a wide variety of standard threshold devices. Additionally, MP3910A has pulse skipping Mode function that improves the efficiency with light load or no load.

The MP3910A is available in SOIC8 package.

ELECTRICAL SPECIFICATIONS

Parameter	Symbol	Value	Units
Input voltage	V _{IN}	9-14	V
Output voltage	V _{OUT}	24	V
Output current	I _{OUT}	2	A

FEATURES

- 9V to 14V Supply Voltage Range
- 1A MOSFET Gate Driver
- External Soft-Start
- Pulse Skipping Operation with Light Load
- Programmable Switching Frequency (30kHz-to-400kHz)
- Cycle-by-Cycle Current Limit
- Over Voltage Protection
- Available in an SOIC8 Package

APPLICATIONS

- Telecom Isolated Power
- Brick Modules
- Off-line Controller
- General Step Up Applications

All MPS parts are lead-free and adhere to the RoHS directive. For MPS green status, please visit MPS website under Products, Quality Assurance page.

"MPS" and "The Future of Analog IC Technology" are Registered Trademarks of Monolithic Power Systems, Inc.

EV3910A-S-00A EVALUATION BOARD



(L x W x H) 2.5" x 2.5" x 0.5"
(6.35cm x 6.35cm x 1.2cm)

Board Number	MPS IC Number
EV3910A-S-00A	MP3910A

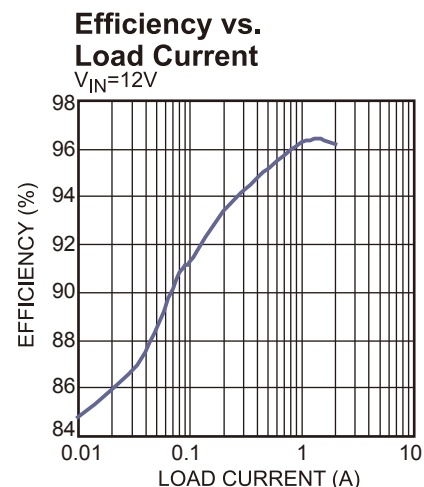

EVALUATION BOARD SCHEMATIC

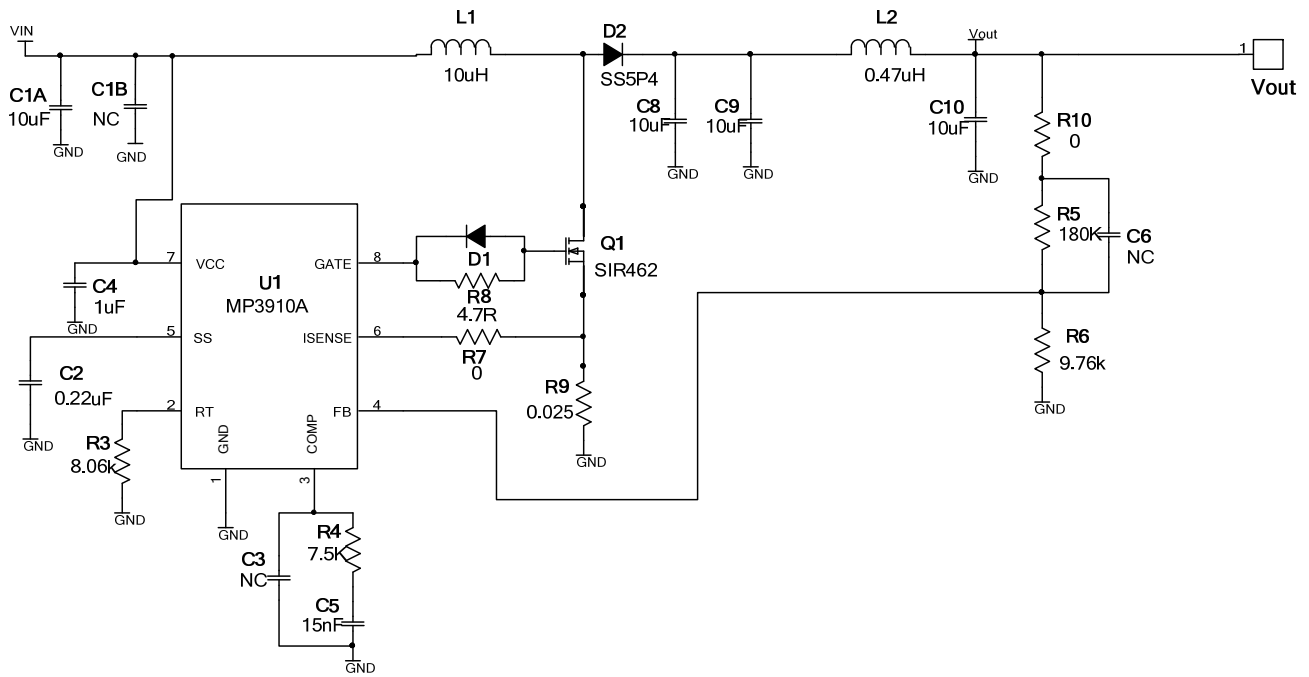

EV3910A-S-00A BILL OF MATERIALS

Qty	Ref	Value	Description	Package	Manufacturer	Part Number
1	C1A	10 μ F	Ceramic Cap., 25V,X7R	1210	muRata	GRM32DR71E106KA12L
1	C2	0.22 μ F	Ceramic Cap.,16V,X7R	0603	muRata	GRM188R71C224KA01D
3	C1B,C3, C6	NC				
1	C4	1.0 μ F	Ceramic Cap.,25V,X7R	0805	muRata	GRM21BR71E105KA99L
1	C5	15nF	Ceramic Cap.,50V,X7R	0603	muRata	GRM188R71H153KA01D
3	C8, C9, C10	10 μ F	Ceramic Cap.,50V,X5R	1210	muRata	GRM32ER61H106KA12L
1	R3	8.06k	Film Res,1%	0603	ROYAL	RL0603FR-078K06L
1	R4	7.5k	Film Res,1%	0603	ROYAL	RL0603FR-077K5L
1	R5	180k	Film Res,1%	0603	ROYAL	RL0603FR-07180KL
1	R6	9.76k	Film Res,1%	0603	ROYAL	RL0603FR-079K76L
2	R7, R10	0R	Film Res,1%	0603	Yageo	RC0603FR-070RL
1	R8	4.7R	Film Res,1%	0603	ROYAL	RL0603FR-074R7L
1	R9	0.025		2512	Yageo	RL2512FK-070R025L
1	D1	1N4148	Diode 75V 250mW	SOD-323	Diodes Inc	1N4148WS-7
1	D2	SS5P4	Switching Diode 40V 5A	TO-277A	Vishay	SS5P4
1	L1	10 μ H	In=9A,Isat=10A		Würth	744 332 100 0
1	L2	0.47 μ H	IR=6.8A,Isat=14.5A	SMD	Würth	744 373 240 047
1	Q1	SIR462	Vds=30V, Rds-on=7.9m Ω	PowerPAK [®] SO-8	Vishay	SiR462DP
1	U1	MP3910A	Controller	SOIC8	MPS	MP3910A

EVB TEST RESULTS

Performance waveforms are tested on the evaluation board.

$V_{IN}=12V$, $V_{OUT}=24V$, $I_{OUT}=2A$, $T_A=25^{\circ}C$, unless otherwise noted.

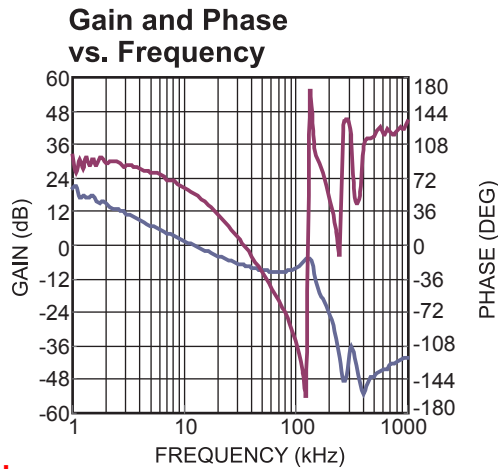
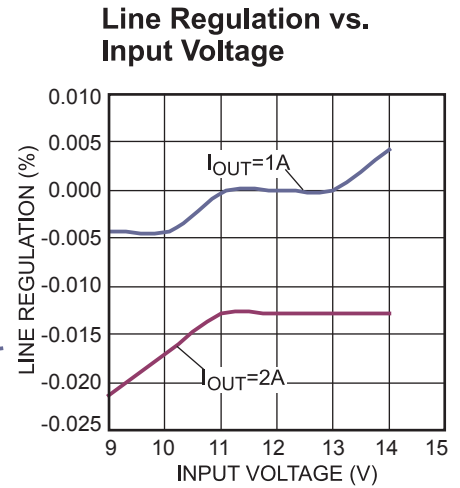
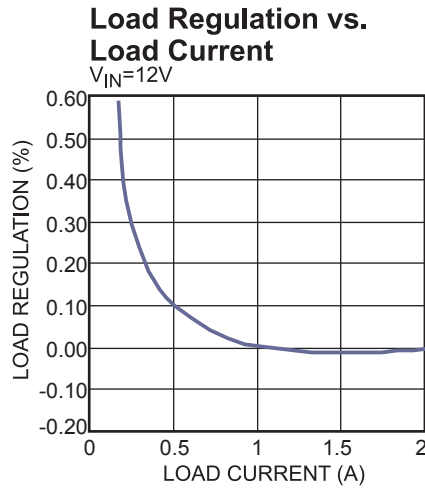
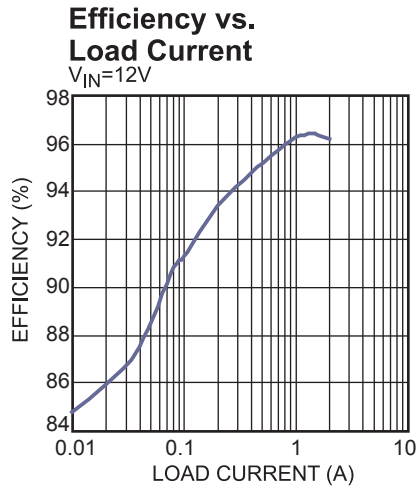

EVB TEST RESULTS *(continued)*

Performance waveforms are tested on the evaluation board.

$V_{IN}=12V$, $V_{OUT}=24V$, $I_{OUT}=2A$, $T_A=25^{\circ}C$, unless otherwise noted.

Steady State

$I_{OUT} = 0A$

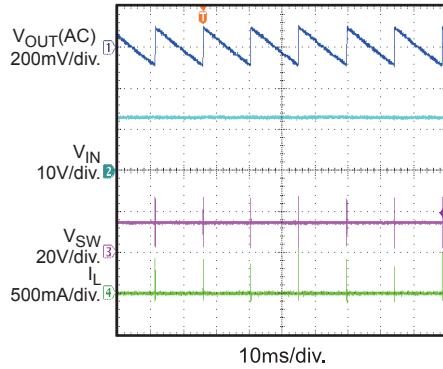

Steady State

$I_{OUT} = 2A$

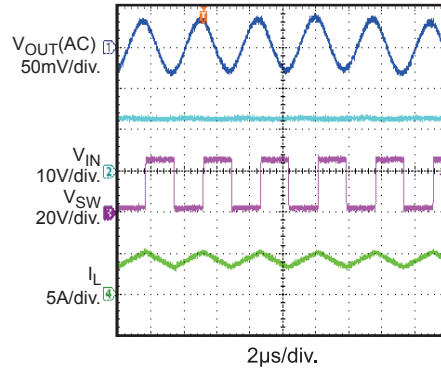

Start-Up through V_{IN}

$I_{OUT} = 0A$

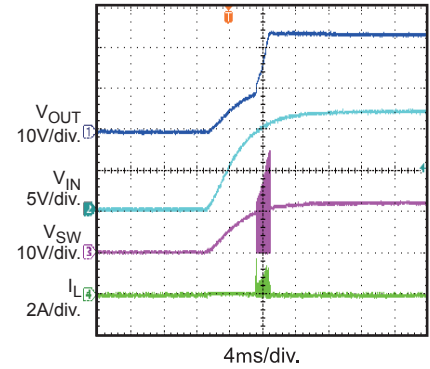

Start-Up through V_{IN}

$I_{OUT} = 2A$

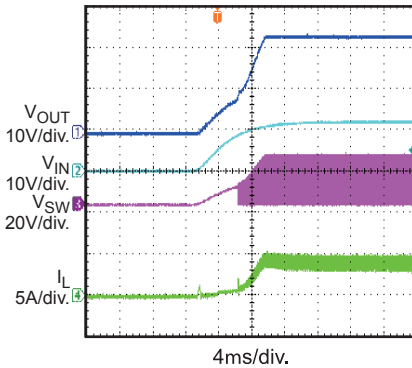

Shutdown through V_{IN}

$I_{OUT} = 0A$

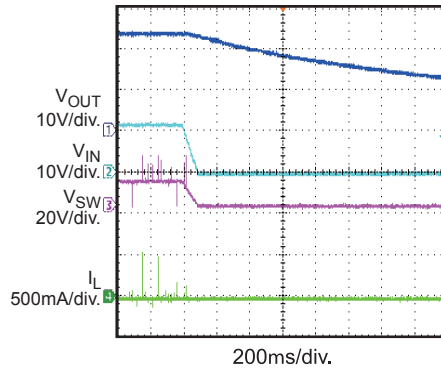

Shutdown through V_{IN}

$I_{OUT} = 2A$

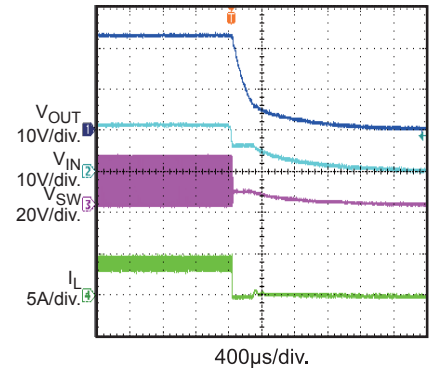

Load Transient

$I_{OUT} = 1A$ to $2A$, $I_{RAMP} = 25mA/\mu s$

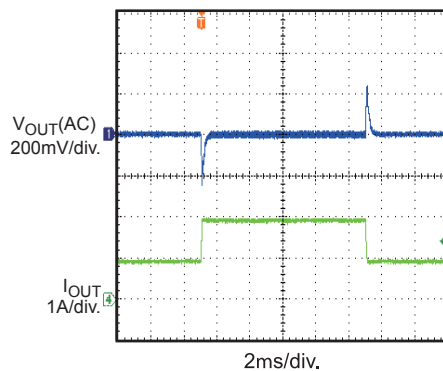

PRINTED CIRCUIT BOARD LAYOUT

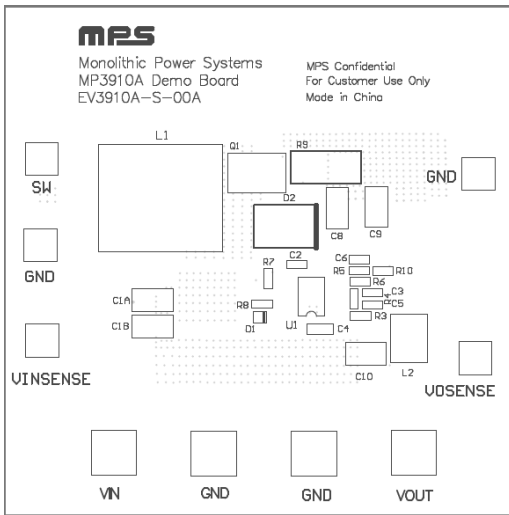

Figure 1: Top Silk Layer

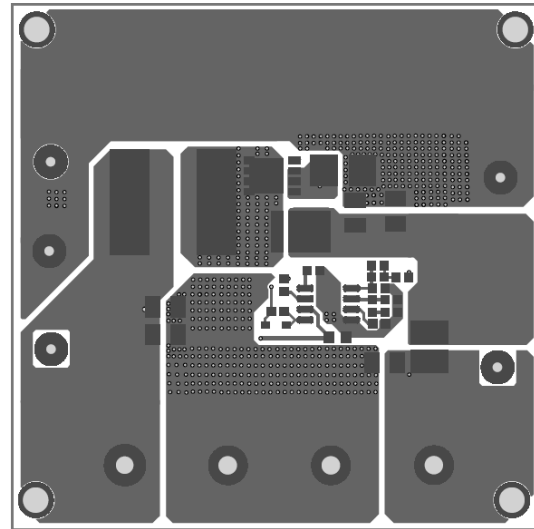

Figure 2: Top Layer

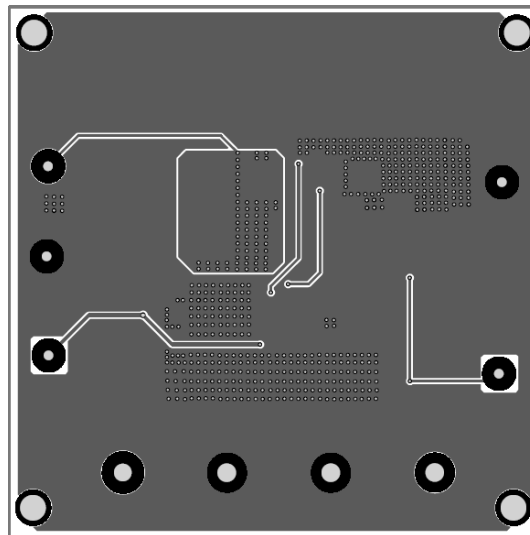

Figure 3: Bottom Layer