

## DESCRIPTION

The EV4026-J-00A Evaluation Board is designed to demonstrate the capabilities of MP4026. The MP4026 is a primary-side-control offline LED lighting controller which can achieve high power factor and accurate LED current for an isolated lighting application in a single stage converter. It works in boundary conduction mode for reducing the MOSFET and Diode switching losses.

The EV4026-J-00A is typically designed for driving an isolated 7W A19 LED bulb with 20V<sub>TYP</sub>, 350mA LED load at universal input (90V~265VAC, 50/60Hz).

The EV4026-J-00A has high performances in efficiency, line/load regulation and meets IEC61547 surges, IEC61000-3-2 Class C harmonics and EN55015 conducted EMI. It has multi-protection function as over-voltage protection, short-circuit protection, primary-side OCP, etc.

## ELECTRICAL SPECIFICATION

Parameter	Symbol	Value	Units
Input Voltage	V <sub>IN</sub>	90 ~ 265	VAC
Output Voltage	V <sub>OUT</sub>	20	V
LED Current	I <sub>LED</sub>	350	mA
Output Power	P <sub>OUT</sub>	7	W
Efficiency (full load)	η	84~87	%
PF		>0.9	

## FEATURES

- Small IC package: SOT23-6
- Real current control without secondary-feedback circuit
- Good line/load regulation
- High power factor>0.9 over universal input voltage
- Boundary conduction mode improves efficiency
- Input UVLO
- Primary-side over current protection
- Over-voltage protection
- Short-circuit protection
- Over-temperature protection
- Fit inside A19 bulb enclosure

## APPLICATIONS

- Solid State Lighting
- Industrial & Commercial Lighting
- Residential Lighting

All MPS parts are lead-free and adhere to the RoHS directive. For MPS green status, please visit MPS website under Quality Assurance. "MPS" and "The Future of Analog IC Technology", are Registered Trademarks of Monolithic Power Systems, Inc.



**Warning:** Although this board is designed to satisfy safety requirements, the engineering prototype has not been agency approved. Therefore, all testing should be performed using an isolation transformer to provide the AC input to the prototype board.

## EV4026-J-00A EVALUATION BOARD

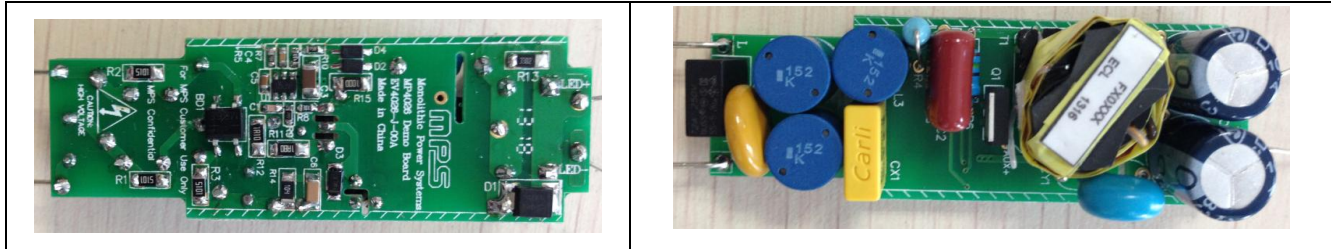

(L x W x H) 66mm x 22.6mm x 23mm

Board Number	MPS IC Number
EV4026-J-00A	MP4026GJ

## EVALUATION BOARD SCHEMATIC

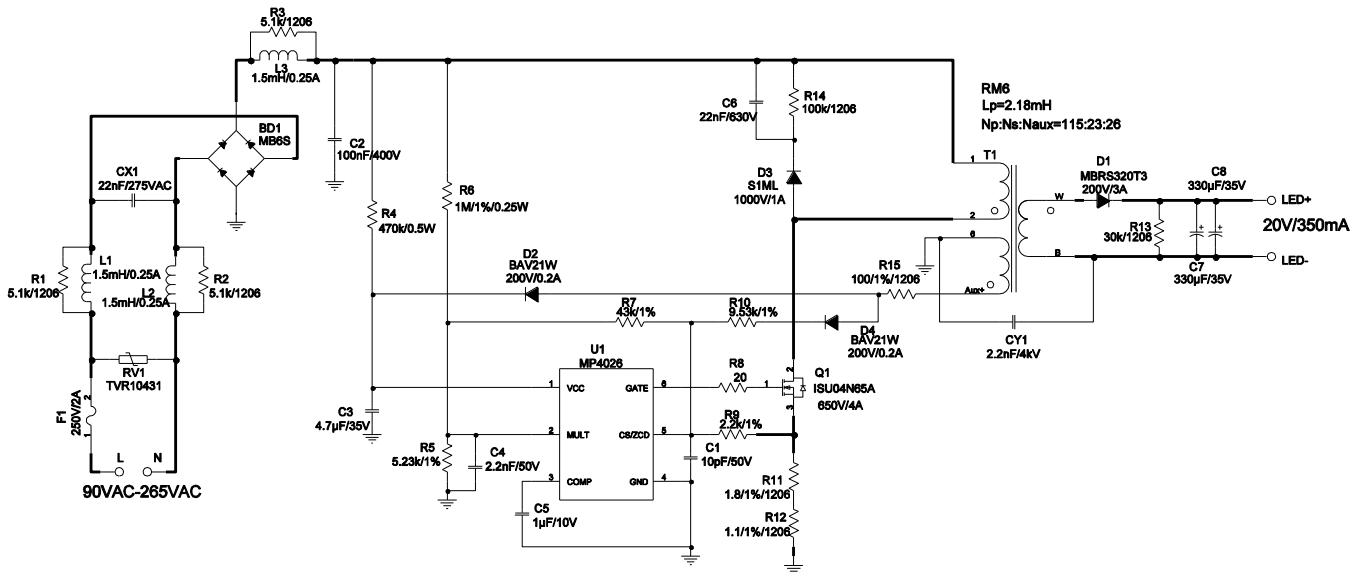
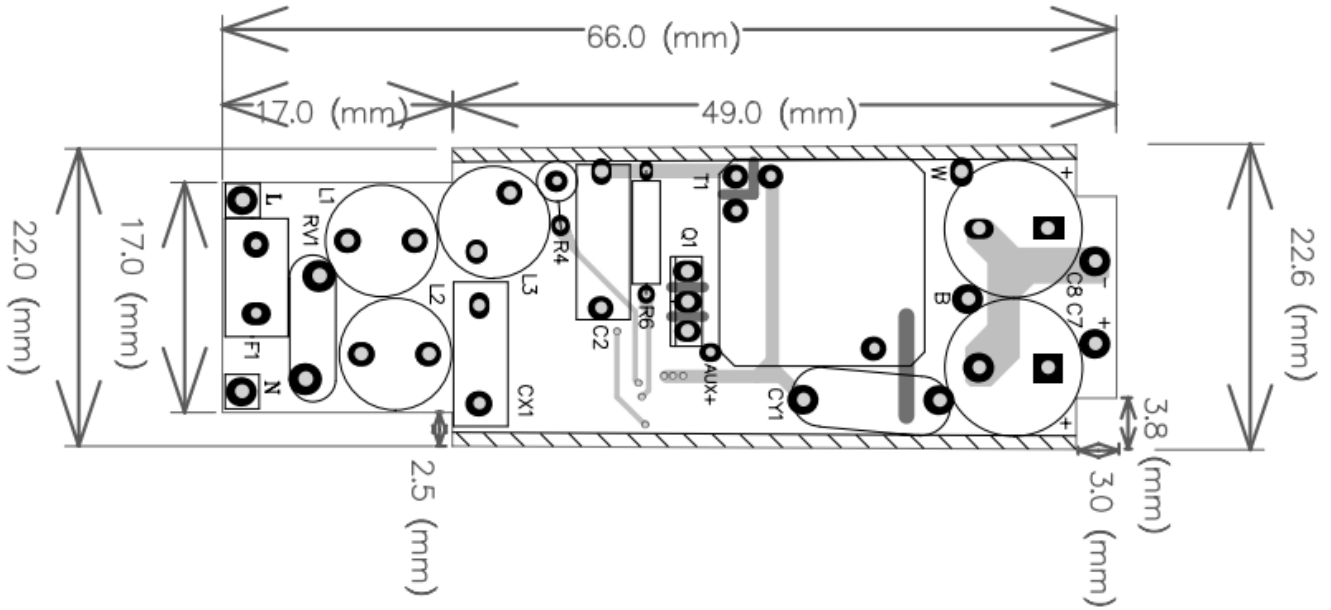
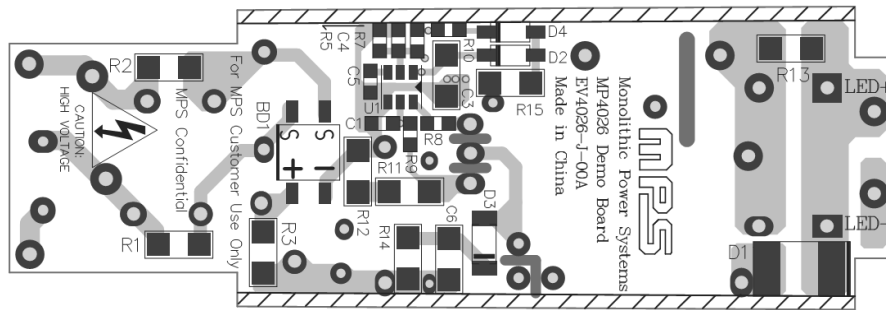

Figure 1 - Schematic

**PCB LAYOUT (DOUBLE-SIDED)**



**Figure 2 - Top Layer**



**Figure 3 - Bottom Layer**

## CIRCUIT DESCRIPTION

The EV4026-J-00A is configured in a single-stage Flyback topology, it uses primary-side-control which can mostly simplify the schematic and get a cost effective BOM. It can also achieve high power factor and accurate LED current.

F1, RV1, CX1, L1, L2, L3, C2 and BD1 compose the input stage. F1 fuses the AC input to protect for the component failure or some excessive short events. RV1 is used to absorb the high ring voltage of surge test, L1, L2, CX1, L3, R1, R2, R3 and C2 associated with CY1 form the EMI filter which can meet the requirement for universal input. The diode rectifier BD1 rectifies the input line voltage. Small bulk CBB capacitor C2 is used for a low impedance path for the primary switching current, to maintain high power factor, the capacitance of C4 should be selected with low value.

R5, R6, C4 provide sine wave reference for the primary peak current to get an active PFC function. The divided voltage should be lower than the max voltage rating of MULT pin.

R4, C3, D2, R15 are used to supply the power for MP4026. A 4.7 $\mu$ F ceramic capacitor C3 is selected to maintain the supply voltage. At start-up, C3 is first charged up by the starter resistor R4 from the line voltage, when the VCC voltage passes the turn on threshold the IC starts to work and the gate begins to switch, then the VCC power supply is taken over by the auxiliary winding through R15, D2.

R9, R10, D4, C1 are used to detect the auxiliary winding to get the transformer magnetizing current zero crossing signal for realizing the boundary conduction operation, and also monitor the output OVP condition. The OVP voltage is set by the divider ratio of R9, R10. D4 is used to block the negative plateau voltage of auxiliary winding when MOSFET is turn on. C1 is used to decouple the high frequency noise influence on CS/ZCD pin.

R11, R12 are primary sensing resistors for primary side current control. The value of R11, R12 set the output LED current. R7 is used to form a feedforward from input line voltage to optimize the line regulation. C6, R14, D3 are used to damp the leakage inductance energy so the drain voltage can be suppressed at a safe level.

Diode D1 rectifies the secondary winding voltage and the capacitor C7, C8 are the output filter. The resistor R13 is placed as pre-load to limit the output voltage rise too high in open load condition.

**EV4026-J-00A BILL OF MATERIALS**

Qty	Ref	Value	Description	Package	Manufacturer	Manufacturer_P/N
1	BD1	MB6S	BRIDGE, 600V, 0.5A	SOIC-4	Taiwan Semiconductor	MB6S
1	C1	10pF/50V	Ceramic Cap,C0G,50V	0603	murata	GRM1885C1H100JA01
1	C2	100nF/400V	CBB, 104/400V	DIP	Panasonic	CBB 0.1μF/400V
1	C3	4.7μF/50V	Ceramic Cap,X7R,50V	1206	murata	GRM31CR71H475KA12L
1	C4	2.2nF/50V	Ceramic Cap,X7R,50V	0603	TDK	C1608X7R1H222K
1	C5	1μF/10V	Ceramic Cap,X7R,10V	0603	murata	GRM188R71A105KA61D
1	C6	22nF/630V	Ceramic Cap,X7R,630V	1206	TDK	C3216X7R2J223K
2	C7,C8	330μF/35V	Electrolytic Capacitor;35V; Electrolytic	DIP	Jianghai	CD263-35V330
1	CX1	22nF/275V	X Capacitor,275V	DIP	Caili	PX223K3IB19L270D9R
1	CY1	2.2nF	Y Capacitor,4000V	DIP	Hongke	JNK12E222MY02N
1	D1	MBRS3200 T3G	Diodes,200V,3A	SMB	ON Semiconductor	MBRS3200T3G
2	D2,D4	BAV21W	Diodes,200V,0.2A	SOD-123	Diodes	BAV21W-7-F
1	D3	S1ML	Diodes,1000V,1A	SMA	Diodes	Taiwan Semiconductor
1	F1	250V/2A	SS-5-2A	DIP	COOPER BUSSMANN	SS-5-2A
3	L1,L2, L3	Inductor, 1.5mH	Inductor,15mH/0.21A	DIP	TDK	TSL0808RRA-152KR21
1	Q1	ISU04N65A	650V/4A	TO-251	IPS	ISU04N65A
3	R1,R2 ,R3	5.1kΩ	RES,1%	1206	Yageo	RC1206FR-075K1L
1	R4	470kΩ	DIP,0.5W RESISTOR	DIP	any	
1	R5	5.23kΩ	Film RES, 1%	0603	Yageo	RC0603FR-075K23L
1	R6	1MΩ	DIP,0.25W RESISTOR	DIP	any	
1	R7	43kΩ	Film RES,1%	0603	LION	RC0603FR-0743KL
1	R8	20Ω	Film RES, 1%	0603	Yageo	RC0603FR-0720RL
1	R9	2.2kΩ	Film RES, 1%	0603	Yageo	RC0603FR-072K2L
1	R10	9.53kΩ	Film RES, 1%	0603	Yageo	RC0603FR-079K53L
1	R11	1.8Ω	RES, 1%	1206	Yageo	RC1206FR-071R8L
1	R12	1.1Ω	Film RES, 1%	1206	Yageo	RC1206FR-071R1L
1	R13	30kΩ	Film RES, 1%	1206	Yageo	RC1206FR-0730KL
1	R14	100kΩ	Film RES,5%	1206	Yageo	RM12JTN104
1	R15	100Ω	Film RES, 1%	1206	Yageo	RC1206FR-07100RL
1	RV1	TVR10431K SY	430V/2500A	DIP	TKS	TVR10431KSY
1	T1	RM6	RM6, Np:Ns:Naux=115:23:26 , Lp=2.18mH	RM6	EMEI	FX0314
1	U1	MP4026	LED Lighting Controller	FCTSOT-6	MPS	MP4026GJ-Z

**TRANSFORMER SPECIFICATION**

**Electrical Diagram**

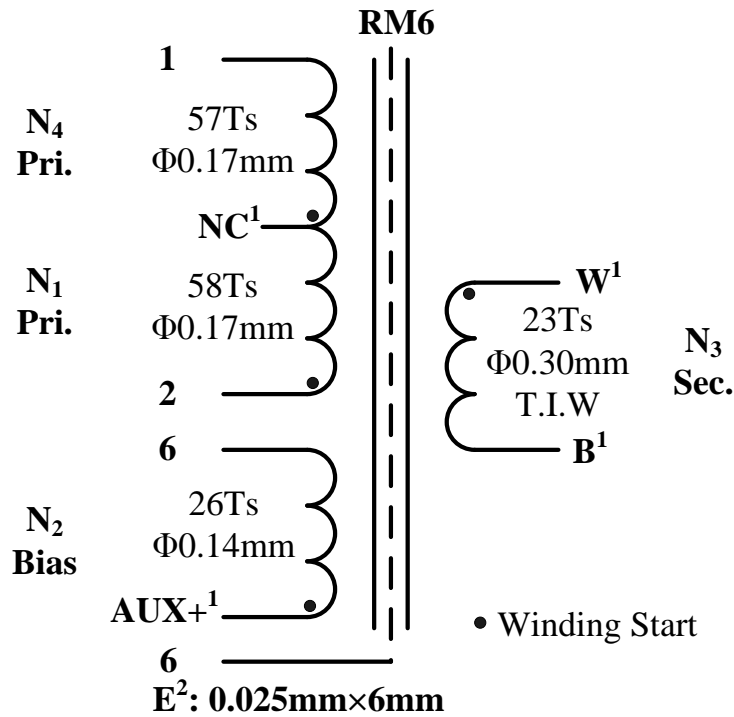
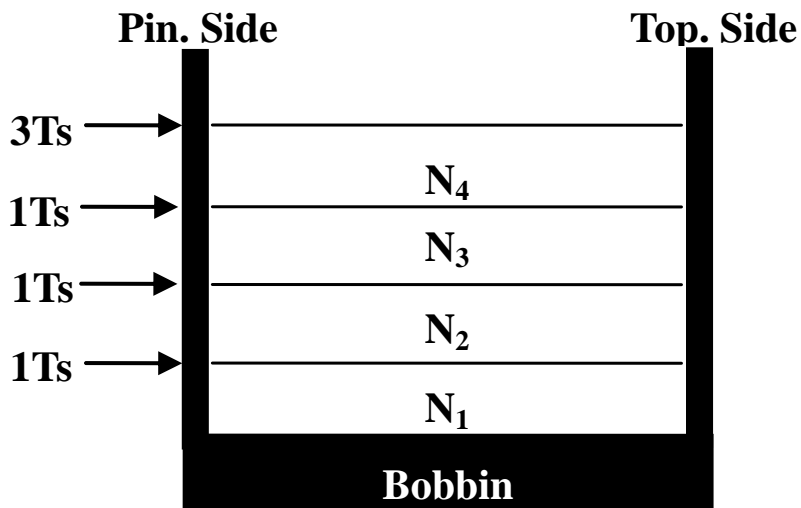

**Figure 4 – Transformer Electrical Diagram**

**Notes:**

1. Don't connect NC, AUX+, W and B to any pin of Bobbin.
2. E is a copper adhered to the core's periphery, and connected to pin6.

**Winding Diagram**



**Figure 5 – Winding Diagram**

## Winding Order

Winding No.	Tape Layer Number	Start & End	Magnet Wire $\Phi$ (mm)	Turns
N <sub>1</sub>	1	2→NC	0.17	58
N <sub>2</sub>	1	AUX+→6	0.14	26
N <sub>3</sub>	1	W→B	0.30 (T.I.W)	23
N <sub>4</sub>	3	NC→1	0.17	57

## Electrical Specifications

<b>Electrical Strength</b>	2 seconds, 60Hz, from Pins 1, 2, 6, AUX+ to W, B	3000VAC
<b>Primary Inductance</b>	Pins 1- 2, all other windings open, measured at 50kHz, 0.1 VRMS	2.18mH±8%
<b>Primary Leakage Inductance</b>	Pins 1-2 with pins 6, AUX+ W, B shorted, measured at 60kHz, 0.1 VRMS	20μH±10%

## Materials

Item	Description
1	Core: RM6, UI=2500±25%, AL=184.5H/N <sup>2</sup> ±3% GAP, ACME P4 or equivalent
2	Bobbin: RM6, 3+3PIN RMMOVE PIN6 1SECT TH, PM9630 UL94V-0
3	Wire: $\Phi$ 0.17mm, $\Phi$ 0.14mm, 2UEW, CLASS B or equivalent
4	Triple Insulation Wire: $\Phi$ 0.30mm, TRW(B) or equivalent
5	Tape: 6.5mm(W)×0.06mm(TH)
6	Tape: 7.0mm(W)×0.06mm(TH)
7	Copper: 6.0mm(W)×0.025mm(TH)
8	Varnish: JOHN C. DOLPH CO, BC-346A or equivalent
9	Adhesive: 400-36 or equivalent
10	Solder Bar: CHEN NAN: SN99.5/Cu0.5 or equivalent

## EVB TEST RESULTS

### Performance Data

V <sub>IN</sub> (VAC)	P <sub>IN</sub> (W)	V <sub>O</sub> (V)	I <sub>6LEDs</sub> (A)	P <sub>O</sub> (W)	Efficiency	PF	I <sub>5LEDs</sub> (A)	I <sub>4LEDs</sub> (A)	I <sub>3LEDs</sub> (A)
90	8.14	19.91	0.345	6.87	84.39%	0.989	0.347	0.352	0.355
100	8.06	19.89	0.345	6.86	85.14%	0.987	0.348	0.352	0.355
110	8.02	19.88	0.345	6.86	85.52%	0.985	0.348	0.352	0.355
120	7.99	19.87	0.345	6.86	85.80%	0.982	0.348	0.352	0.355
135	7.97	19.86	0.345	6.85	85.97%	0.978	0.348	0.352	0.355
150	7.96	19.86	0.345	6.85	86.08%	0.972	0.348	0.352	0.356
170	7.96	19.86	0.345	6.85	86.08%	0.963	0.349	0.353	0.357
185	7.97	19.85	0.345	6.85	85.93%	0.956	0.349	0.353	0.357
200	7.99	19.84	0.345	6.84	85.67%	0.947	0.349	0.353	0.357
220	8.03	19.85	0.345	6.85	85.28%	0.934	0.349	0.354	0.358
230	8.04	19.84	0.345	6.84	85.13%	0.927	0.349	0.354	0.358
240	8.06	19.84	0.345	6.84	84.92%	0.92	0.349	0.354	0.358
250	8.08	19.83	0.346	6.86	84.92%	0.911	0.35	0.354	0.359
265	8.12	19.82	0.346	6.86	84.45%	0.9	0.35	0.355	0.359

### Harmonic Data

The design passes EN6100-3-2 Class C requirement.

110V Harmonic Order	Limit (Active input power <25W)	Content mA	Test Result (Pass/Fail)	230V Harmonic Order	Limit (Active input power <25W)	mA Content	Test Result (Pass/Fail)
1		73.38		1		37.13	
3	57.12	10.48	Pass	3	28.80	7.93	Pass
5	31.92	2.37	Pass	5	16.09	2.65	Pass
7	16.80	0.51	Pass	7	8.47	1.27	Pass
9	8.40	0.76	Pass	9	4.24	0.78	Pass
11	5.88	0.93	Pass	11	2.96	0.59	Pass
13	4.98	0.94	Pass	13	2.51	0.53	Pass
15	4.31	0.87	Pass	15	2.17	0.51	Pass
17	3.80	0.74	Pass	17	1.92	0.45	Pass
19	3.40	0.55	Pass	19	1.72	0.36	Pass
21	3.08	0.35	Pass	21	1.55	0.25	Pass
23	2.81	0.17	Pass	23	1.42	0.22	Pass
25	2.59	0.12	Pass	25	1.30	0.2	Pass
27	2.40	0.20	Pass	27	1.21	0.19	Pass
29	2.23	0.30	Pass	29	1.12	0.16	Pass
31	2.09	0.37	Pass	31	1.05	0.15	Pass
33	1.96	0.45	Pass	33	0.99	0.22	Pass
35	1.85	0.49	Pass	35	0.93	0.25	Pass
37	1.75	0.45	Pass	37	0.88	0.25	Pass
39	1.66	0.39	Pass	39	0.84	0.25	Pass



### Electric Strength Test

Primary circuit to secondary circuit electric strength testing was completed according to IEC61347-1 and IEC61347-2-13.

Input and output was shorted respectively. 3750VAC/50Hz sine wave applied between input and output for 1min, and operation was verified.

### Surge Test

Line to Line 500V and Line to Power Earth 1kV surge testing was completed according to IEC61547. Input voltage was set at 230VAC/50Hz. Output was loaded at full load and operation was verified following each surge event.

Surge Level (V)	Input Voltage (VAC)	Injection Location	Injection Phase (°)	Test Result (Pass/Fail)
500	230	L to N	90	Pass
-500	230	L to N	270	Pass
1000	230	L to PE	90	Pass
-1000	230	L to PE	270	Pass
1000	230	N to PE	90	Pass
-1000	230	N to PE	270	Pass

## EVB TEST RESULTS

Performance waveforms are tested on the evaluation board.  
 6 LEDs in series,  $I_{LED}=350\text{mA}$ ,  $V_{OUT}=20\text{V}$ ,  $L_P=2.18\text{mH}$ ,  $N_p:N_s:N_{AUX}=115:23:26$ .

**Line/Load Regulation**

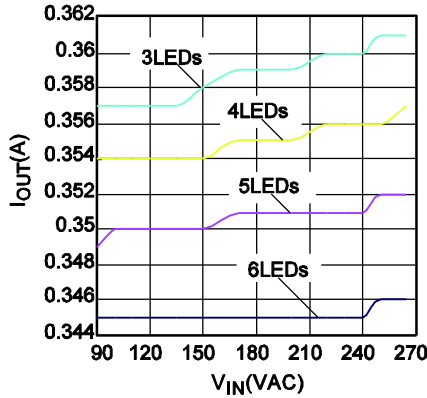

**Efficiency**

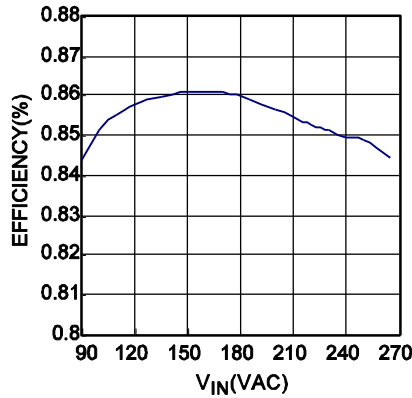

**PF @Full Load**

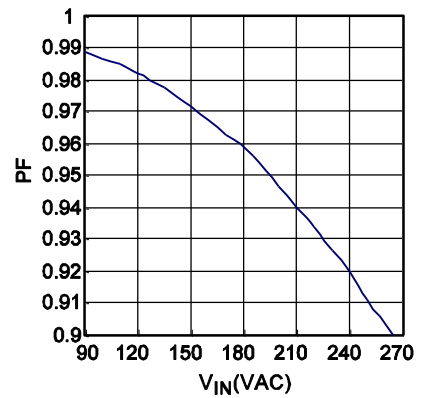

**Conduction EMI**

110VAC, RBW=9kHz, MT=20ms

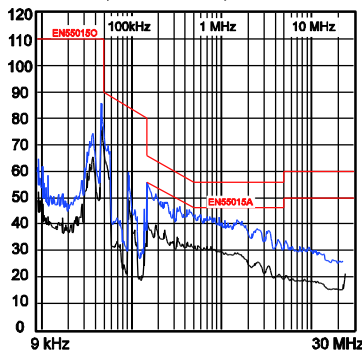

**CDN Test**

110VAC, RBW=120kHz, MT=1ms

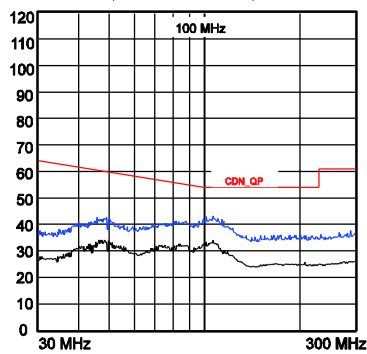

**Conduction EMI**

230VAC, RBW=9kHz, MT=20ms

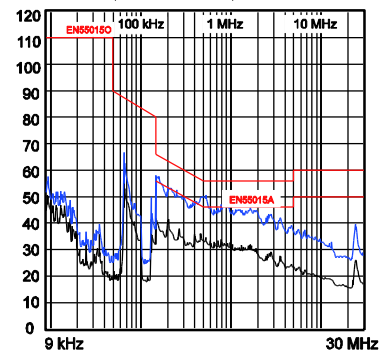

**CDN Test**

230VAC, RBW=120kHz, MT=1ms

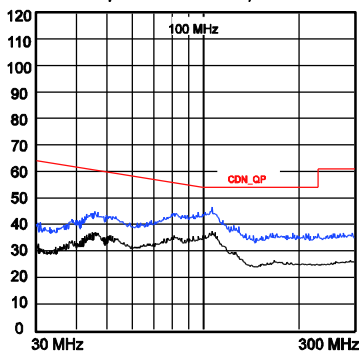

**EVB TEST RESULTS** *(continued)*

Performance waveforms are tested on the evaluation board.

6 LEDs in series,  $I_{LED}=350mA$ ,  $V_{OUT}=20V$ ,  $L_P=2.18mH$ ,  $N_P:N_S:N_{AUX}=115:23:26$ .

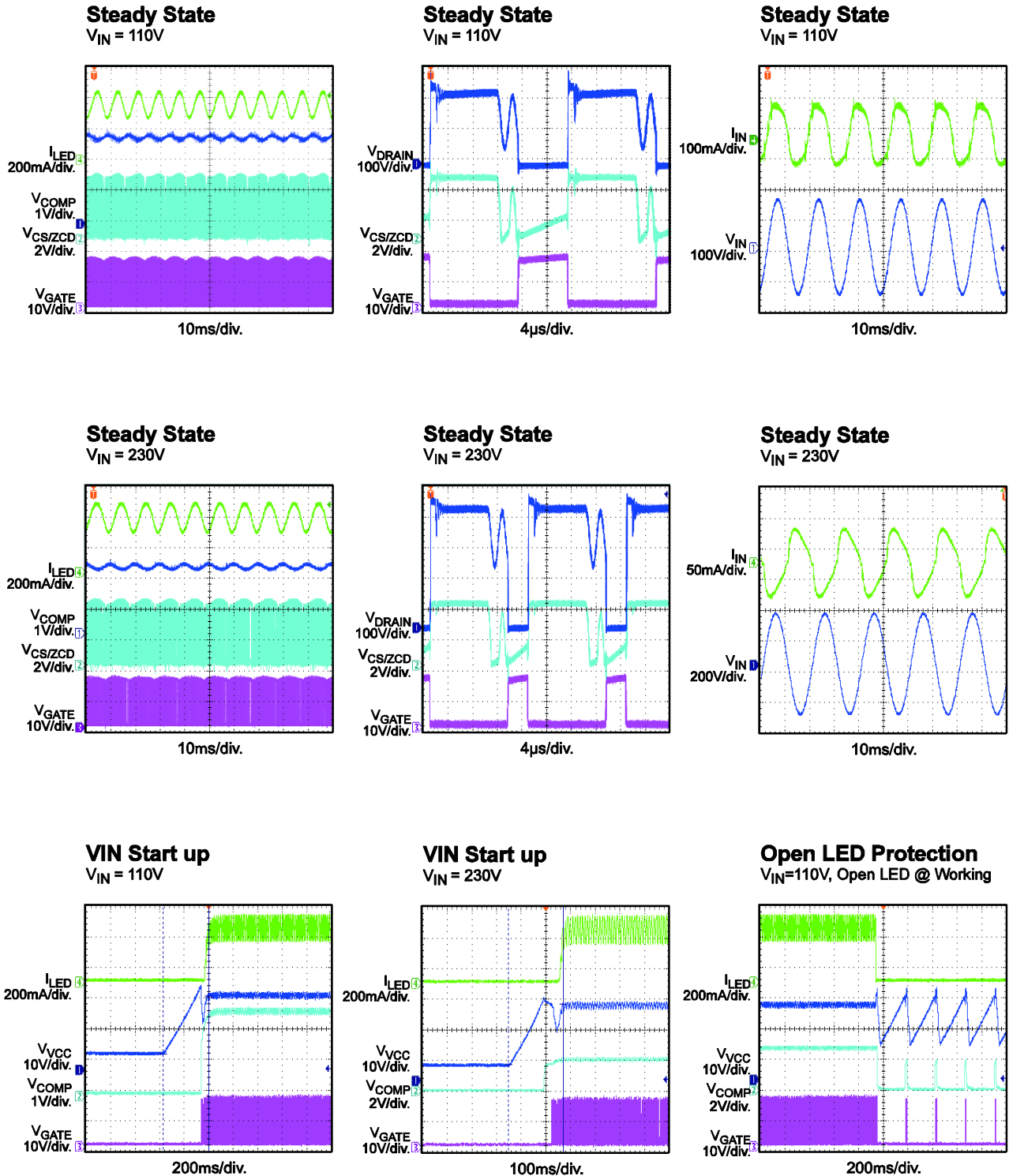

**EVB TEST RESULTS** *(continued)*

Performance waveforms are tested on the evaluation board.

6 LEDs in series,  $I_{LED}=350mA$ ,  $V_{OUT}=20V$ ,  $L_P=2.18mH$ ,  $N_P:N_S:N_{AUX}=115:23:26$ .

**Open LED Protection**

$V_{IN}=230V$ , Open LED @ Working

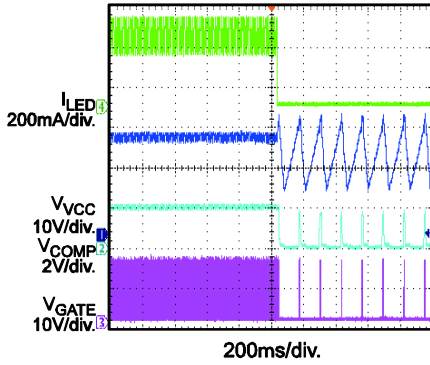

**Short Circuit Protection**

$V_{IN}=110V$ , Short LED+ to LED- @ Working

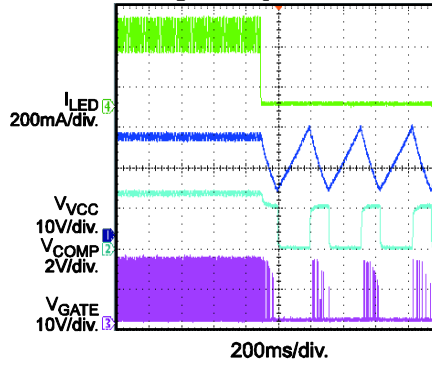

**Short Circuit Protection**

$V_{IN}=230V$ , Short LED+ to LED- @ Working

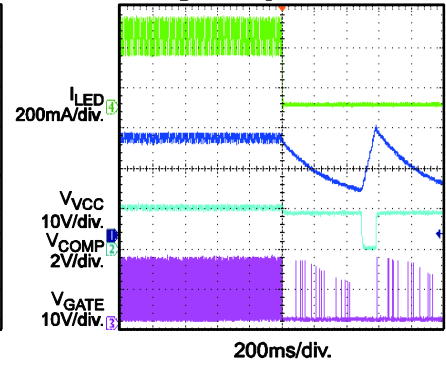

**Primary-Side OCP Protection**

$V_{IN}=110V$ , Short primary winding @ Working

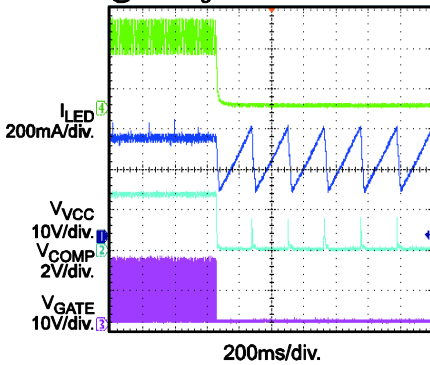

**Primary-Side OCP Protection**

$V_{IN}=230V$ , Short primary winding @ Working

