

## DESCRIPTION

The EV4056-S-00A Evaluation Board is designed to demonstrate the capabilities of MP4056. The MP4056 is a non-isolated, TRIAC dimmable LED controller with active PFC and excellent dimming performance.

It works in boundary conduction mode for reducing the MOSFET and Diode switching losses. Its adaptive dimmer type detection and phase-cut-based dimming control can achieve good dimmer compatibility and deep dimming range.

The EV4056-S-00A is typically designed for driving a 10W TRIAC dimmable LED bulb with 50V<sub>TYP</sub>, 200mA LED load from 108VAC to 132VAC, 60Hz.

The EV4056-S-00A has a cost effective BOM and excellent efficiency. It meets IEC61547 surge immunity, IEC61000-3-2 Class C harmonics and EN55015 conducted EMI requirements. It has multi-protection function as over-voltage protection; winding short circuit protection; output short-circuit protection; ZCD pin short protection; over-temperature protection etc.

## ELECTRICAL SPECIFICATION

Parameter	Symbol	Value	Units
Input Voltage	V <sub>IN</sub>	108 to 132	VAC
Output Voltage	V <sub>OUT</sub>	50	V
LED Current	I <sub>LED</sub>	200	mA
Output Power	P <sub>OUT</sub>	10	W
Efficiency (full load)	η	>85	%
Power Factor	PF	>0.93	
THD	THD	<20	%

## FEATURES

- Single Winding Inductor
- Adaptive Dimmer Type Detection and Phase-Cut-Based Dimming Control
- Good Dimmer Compatibility and Deep Dimming Range
- Fast Start-Up without Perceptible Delay
- Accurate Line & Load Regulation
- High Power Factor
- Operates in Boundary Conduction Mode
- Cycle-by-Cycle Current Limit
- Winding Short-Circuit Protection
- Output Over-Voltage Protection
- Output Short-Circuit Protection
- ZCD Pin Short Protection
- Over-Temperature Protection
- Fit inside A19 Bulb Enclosure

## APPLICATIONS

- Solid State Lighting
- Industrial & Commercial Lighting
- Residential Lighting

All MPS parts are lead-free, halogen free, and adhere to the RoHS directive. For MPS green status, please visit MPS website under Quality Assurance.

“MPS” and “The Future of Analog IC Technology” are Registered Trademarks of Monolithic Power Systems, Inc.



**Warning:** Although this board is designed to satisfy safety requirements, the engineering prototype has not been agency approved. Therefore, all testing should be performed using an isolation transformer to provide the AC input to the prototype board.

### EV4056-S-00A EVALUATION BOARD

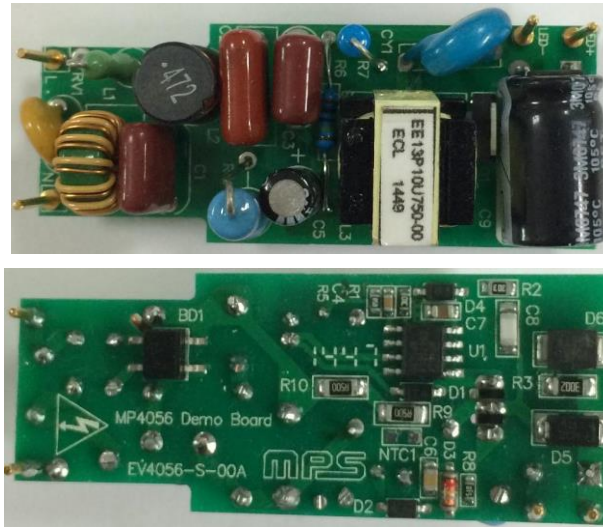

(L x W x H) 56mm x 22mm x 19mm

Board Number	MPS IC Number
EV4056-S-00A	MP4056GS

### EVALUATION BOARD SCHEMATIC

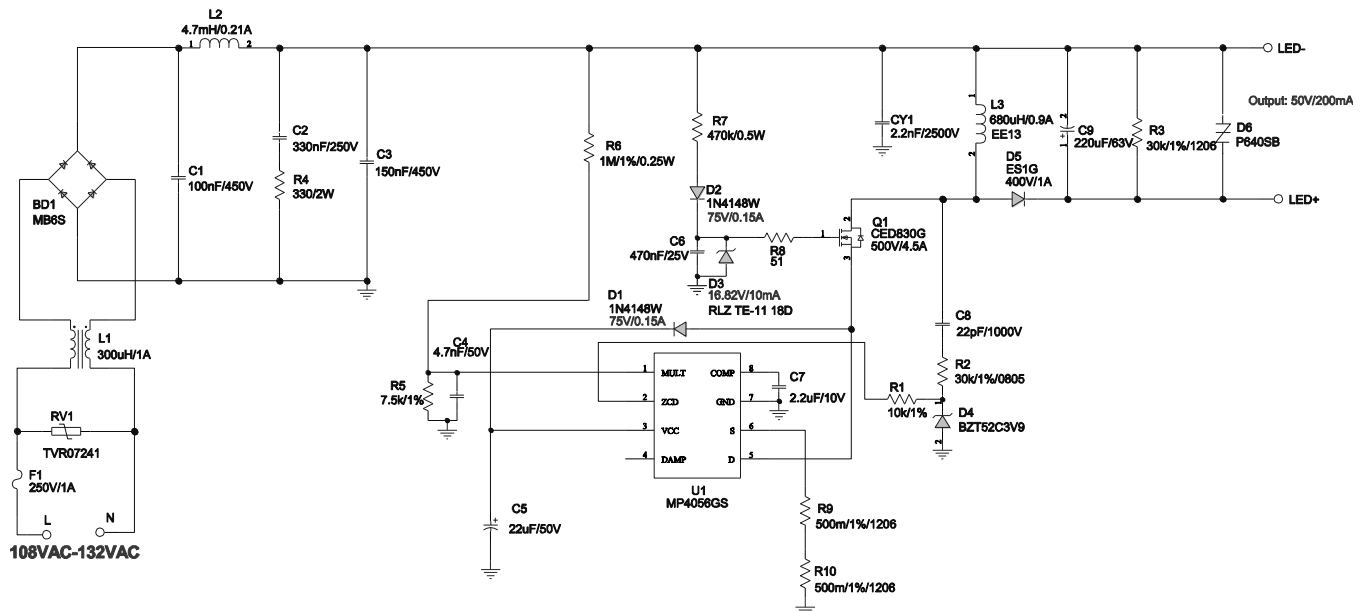

Figure 1—Schematic

### PCB LAYOUT (SINGLE-SIDED)

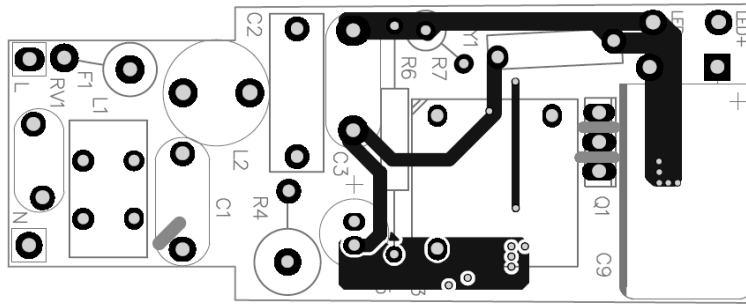

Figure 2—Top Layer

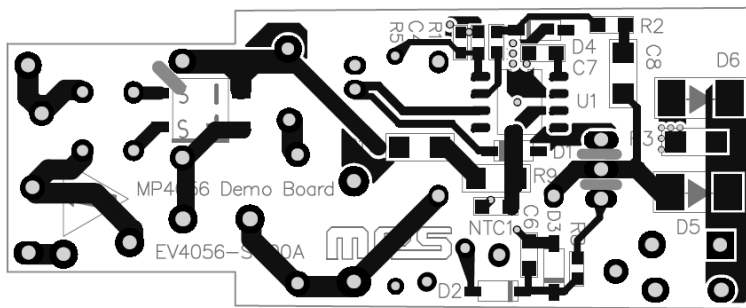

Figure 3—Bottom Layer

## CIRCUIT DESCRIPTION

The EV4056-S-00A is configured in a single-stage Buck-boost topology and gets a cost effective BOM with using single winding inductor. It achieves high power factor and excellent TRIAC dimming performance.

F1, RV1, L1 and BD1 compose the input stage. F1 fuses the AC input to protect the component failure or some excessive short events. RV1 is used for surge test. L1 is a high frequency common mode filter. The diode rectifier BD1 rectifies the input line voltage.

C1, L2 and C3 form a  $\pi$  EMI filter. C2, R4 are used as a passive bleeder which helps keep the TRIAC current above the minimum holding current after TRIAC turns on.

R5, R6, C4 provide sine wave reference for the current control loop to get an active PFC function.

D1 and C5 are used to supply the power for MP4056. A 22 $\mu$ F electrolytic capacitor C5 is selected to maintain the supply voltage. At start-up, C5 is charged up through Q1, D1 and the internal charging circuit, when the VCC voltage reaches VCC<sub>EN</sub>, the internal charging circuit stops charging. Then the power supply is charged by Q1, D1 during the switching off time.

R7, C6, D2, and D3 are used for the gate driver of the external MOSFET Q1. R8 is used to adjust the driver capability for better EMI and small power loss.

C8, R1, R2 and D4 are used to detect the inductor L3 magnetizing current zero crossing signal for realizing the boundary conduction operation. C8 is a high-pass filter for the magnetizing signal. D4 is used to clamp the signal steady status voltage. R1, R2 are used to limit the current flow to D4 and ZCD pin.

R9, R10 are sensing resistors for current control. The value of R9 and R10 set the output LED current.

Diode D5 is the output rectifying diode. The capacitor C9 is the output filter. The resistor R3 is placed as a dummy load to consume the output power in open load condition. The sidactor D6 is used to limit the output maximum voltage in open load condition. The CY1 is a Y-cap, used to help improve the EMI performance.

**EV4056-S-00A BILL OF MATERIALS**

Qty	Ref	Value	Description	Package	Manufacturer	Manufacturer_P/N
1	BD1	MB6S	BRIDGE, 600V, 0.5A	SOIC-4	Taiwan Semi	MB6S
1	C1	100nF/450V	CBB,450V	DIP	Fala	C222S104K30C000
1	C2	330nF/250V	CBB,250V	DIP	Haimenyinyan	CL21XX
1	C3	150nF/450V	CBB,450V	DIP	Fala	C222S154K30C000
1	C4	4.7nF/50V	Ceramic Cap,X7R,50V	0603	muRata	GRM188R71H472KA01D
1	C5	22uF/50V	Electrolytic Capacitor;50V	DIP	Jianghai	CD281L-50V22
1	C6	470nF/25V	Ceramic Cap,X7R,25V	0603	muRata	GRM188R71E474KA12D
1	C7	2.2uF/10V	Ceramic Cap,10V,X7R	0805	muRata	GRM21BR71A225KA01L
1	C8	22pF/1000V	Ceramic Cap,1000V	1206	muRata	GRM31A5C3A220JW01D
1	C9	220uF/63V	Electrolytic Capacitor, 63V	DIP	Rubycon	220uF/63V
1	CY1	2.2nF/250V	Y Capacitor,2500V	DIP	Hongke	JNK12E222ML02N
2	D1, D2	1N4148W	Diode,75V,0.15A	SOD-123	Diodes	1N4148W
1	D3	RLZ TE-11 18D	Zener Diode,16.82V, 10mA	SOD-123	ROHM	RLZ TE-11 18D
1	D4	BZT52C3V9	Zener Diode, 3.9V, 5mA	SOD-123	Diodes	BZT52C3V9
1	D5	ES1G	Diode,400V,1A	SMA	PREMIER	ES1G
1	D6	P640SB	Sidactor,77V	SMA	LEAD EMC	P640SB
1	F1	250V/1A	Fuse	DIP	any	250V/1A
1	L1	300uH/1A	TP4U300-00	DIP	Emei	TP4U300-00
1	L2	Inductor,4.7mH	Inductor,4.7mH/0.21A	DIP	Wurth	7447724472
1	L3	EE13	EE13,Np=160,Lp=750uH	EE13	Emei	FX0393
1	Q1	CED830G	N-Channel MOSFET, 500V, 4.5A	TO-251	CET	CED830G
1	R1	10kΩ	Film Resistor, 1%	0603	Yageo	RC0603FR-0710KL
1	R2	30kΩ	Film 'Resistor,1%	0805	LIZ	CR05T05NJ30K
1	R3	30kΩ	Film 'Resistor,1%	1206	Yageo	RC1206FR-0730kL
1	R4	330Ω	Resistor,5%,2W	DIP	any	330Ω/2W
1	R5	7.5kΩ	Film 'Resistor,1%	0603	Yageo	RC0603FR-077K5L
1	R6	1MΩ	Resistor,5%,0.25W	DIP	any	1MΩ/0.25W

**EV4056-S-00A BILL OF MATERIALS** *(continued)*

Qty	Ref	Value	Description	Package	Manufacturer	Manufacturer_P/N
1	R8	51Ω	Film 'Resistor,1%	0603	Yageo	RC0603FR-0751RL
1	R7	470kΩ/0.5W	Resistor;5%;0.5W	DIP	any	470kΩ/0.5W
2	R9, R10	500mΩ	Film 'Resistor,1%	1206	Yageo	RC1206FR-070R5L
1	RV1	TVR07241	240V/2500A	DIP	TKS	TVR07241
1	U1	MP4056GS	MP4056GS	SOIC8	MPS	MP4056GS R3

**TRANSFORMER SPECIFICATION**

**Electrical Diagram**

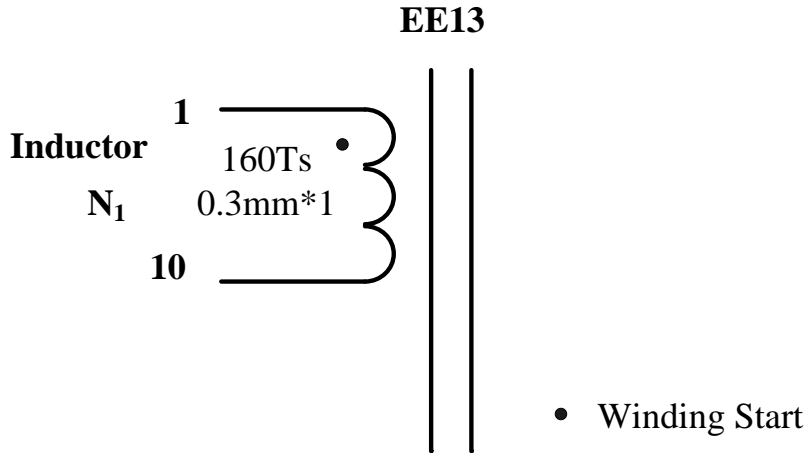

**Figure 4—Transformer Electrical Diagram**

**Winding Diagram**

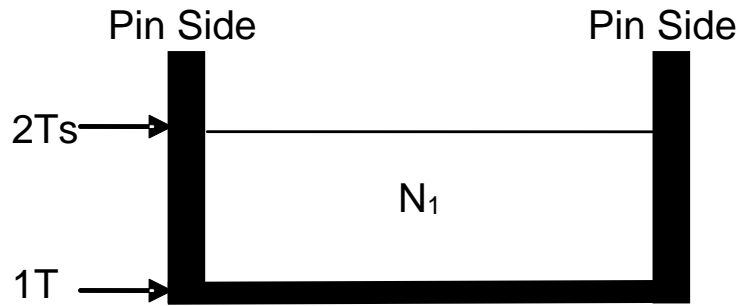

**Figure 5—Winding Diagram**

**Winding Order**

Winding No.	Tape Layer Number	Start & End	Magnet Wire $\Phi$ (mm)	Turns
	1			
N <sub>1</sub>	2	1→10	0.3mm * 1	160

**Electrical Specifications**

<b>Electrical Strength</b>	60 second, 60Hz, from Winding to CORE.	1000VAC
<b>Inductance</b>	Pins 1 - 10, all other windings open, measured at 60kHz, 0.1 VRMS	750uH±8%

**Materials**

Item	Description
1	Core: EE13, UI=2500±25%, ACME P4 or equivalent
2	Bobbin: EE13, 5+5PIN, REMOVE PIN2,3,4,6,7,8,9
3	Wire: $\Phi$ 0.3mm, 2UEW, CLASS F or equivalent
4	Tape: 6.5mm(W)×0.06mm(TH)
5	Varnish: JOHN C. DOLPH CO, BC-346A or equivalent
6	Solder Bar: CHEN NAN: SN99.5/Cu0.5 or equivalent



## EVB TEST RESULTS

### Performance Data

#### Efficiency, PF and THD

f (Hz)	Vin(V)	Pin(W)	Vo(V)	Io(mA)	Po(W)	Efficiency(%)	PF	THD(%)
60	108	11.49	50.20	198.0	9.940	86.51	0.964	18.3
	120	11.46	50.20	198.0	9.940	86.73	0.955	19.4
	132	11.46	50.20	199.0	9.990	87.17	0.936	19.9

#### Dimming Compatibility (No flicker and shimmer with these 29 different Dimmers)

Dimmer No.	Manufacturer	Part No.	Power Stage	I <sub>max</sub> (mA)	I <sub>min</sub> (mA)
1	LUTRON	Q-600P-IV	600W Incandescent	201	2
2	LUTRON	CN-600P	600W	200	5
3	LUTRON	AY-600P	600W	200	8
4	LUTRON	SLV-600P	600W	200	8
5	LUTRON	LG-600P	600W	200	5
6	LUTRON	6B38-Q-600P	600W	200	9
7	LUTRON	GL-600H-DK	600W Incandescent	200	3
8	LEVITON	1G40O5	600W	200	0
9	LEVITON	1I20O5	600W	200	0
10	LUTRON	GLV02-F06392	600W	200	0
11	LEVITON	6633-P	600W	200	0
12	LUTRON	6B38-S-600P	600W	200	1
13	LUTRON	CT-600P	600W	200	3
14	LUTRON	6B38-S-603PG	600W	166	5
15	LUTRON	6B38-DV-600P	600W	200	3
16	LUTRON	6B38-DVLV-600P	600W	199	10
17	LEVITON	1L10O5	600W	199	0
18	LUTRON	GLS01-C06570	600W	167	0
19	LUTRON	DV-600P-BR	600W Incandescent	199	4
20	LEVITON	C20-6684-IW	600W Incandescent	199	0
21	LUTRON	AY-600P-LA	600W Incandescent	200	13
22	LUTRON	TG-600PH-WH	600W	200	10
23	LUTRON	TG-603GH-WH	600W	200	9
24	LUTRON	S-600	600W	199	2
25	LUTRON	DVPDC-203P-WH	200W for Philips dimmable CFL	199	31
26	LUTRON	S-600P	600W	199	1
27	LUTRON	6B38-DV-603PG	600W	165	6
28	COOPER	6B28	600W	199	0
29	LEVITON	6633-P-1G10O5	600W	199	1

**Electric Strength Test**

Input and output was shorted respectively. 3750VAC/50Hz sine wave applied between input and output for 1min, and operation was verified.

**Surge Test**

Line to Line 500V surge testing was completed according to IEC61547.

Input voltage was set at 120VAC/60Hz. Output was loaded at full load and operation was verified following each surge event.

Surge Level (V)	Input Voltage (VAC)	Injection Location	Injection Phase (°)	Test Result (Pass/Fail)
500	120	L to N	90	Pass
-500	120	L to N	270	Pass

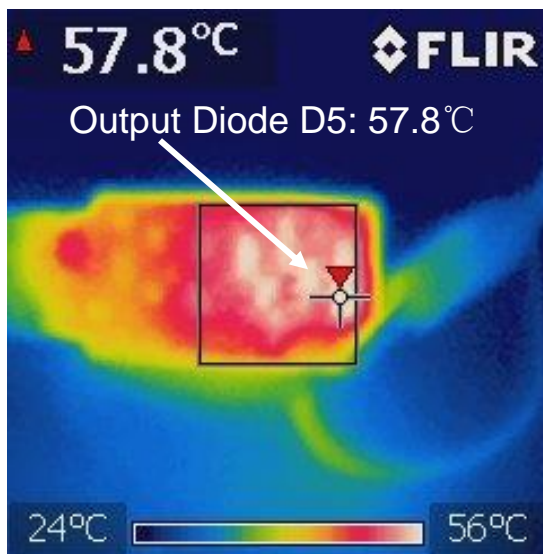
**Thermal Test**

**Without dimmer**

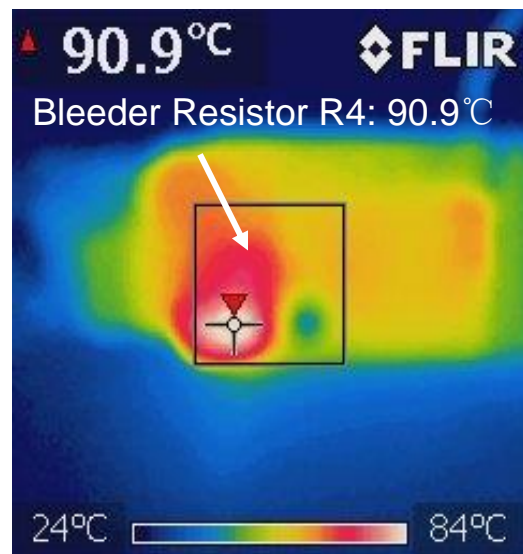

**Leading edge dimmer with 50% turn on phase**

## EVB TEST RESULTS

Performance waveforms are tested on the evaluation board.

$V_{IN}=120V_{AC}/60Hz$ , 16 LEDs in series,  $I_{LED}=200mA$ ,  $V_{OUT}=50V$ .

### Line Regulation

$V_{IN}=(108-132)V_{AC}/60Hz$ , Full Load

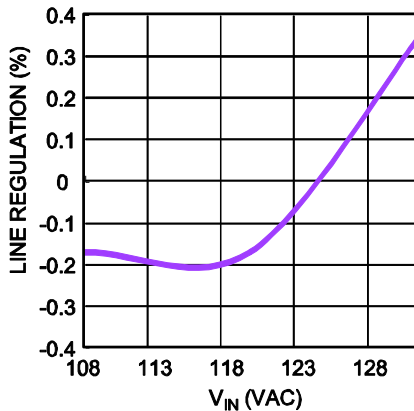

### Efficiency vs. $V_{IN}$

$V_{IN}=(108-132)V_{AC}/60Hz$ , Full Load

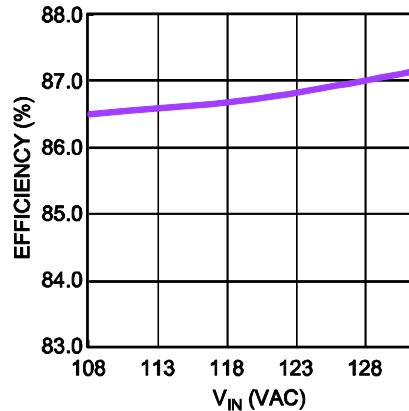

### PF vs. $V_{IN}$

$V_{IN}=(108-132)V_{AC}/60Hz$ , Full Load

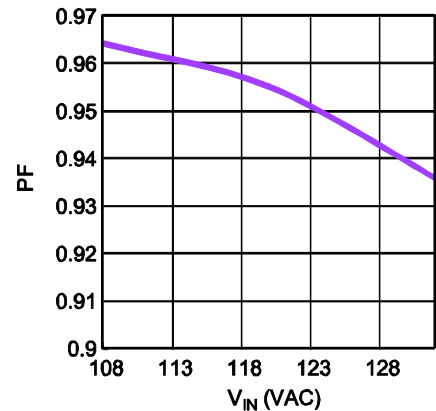

### THD vs. $V_{IN}$

$V_{IN}=(108-132)V_{AC}/60Hz$ , Full Load

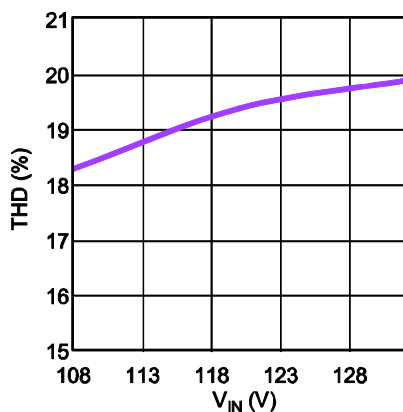

### Dimming Curve

$V_{IN}=120V_{AC}/60Hz$ , Full Load, with Different Dimmers

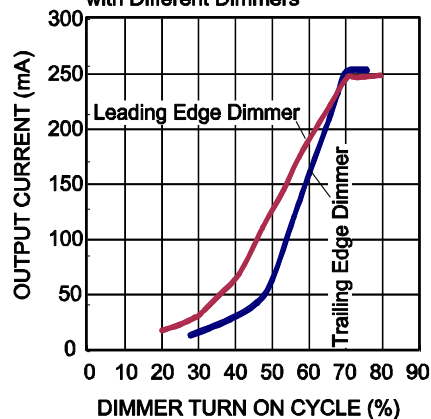

### Conducted EMI, L-Line

$V_{IN}=120V_{AC}/60Hz$ , RBW=9kHz, MT=20ms

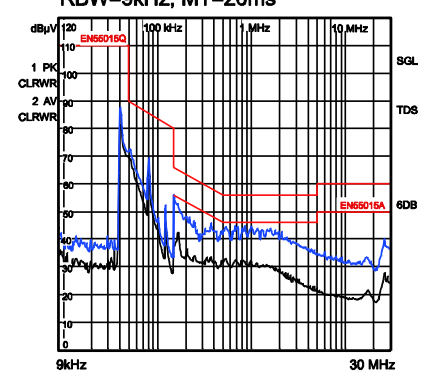

### Conducted EMI, N-Line

$V_{IN}=120V_{AC}/60Hz$ , RBW=9kHz, MT=20ms

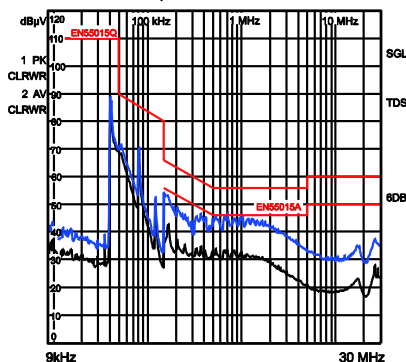

### CDN Test

$V_{IN}=120V_{AC}/60Hz$ , RBW=120kHz, MT=1ms

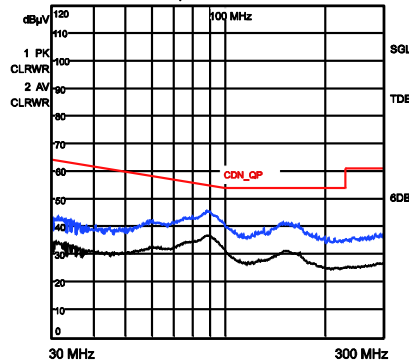

**EVB TEST RESULTS (continued)**

Performance waveforms are tested on the evaluation board.

 $V_{IN}=120V_{AC}/60Hz$ , 16 LEDs in series,  $I_{LED}=200mA$ ,  $V_{OUT}=50V$ .

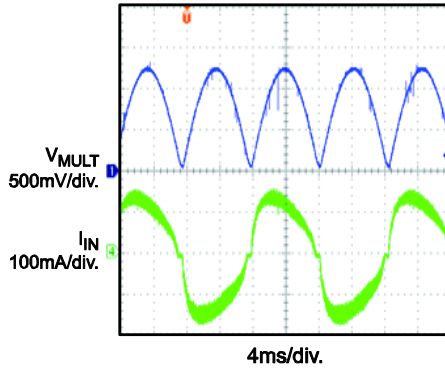
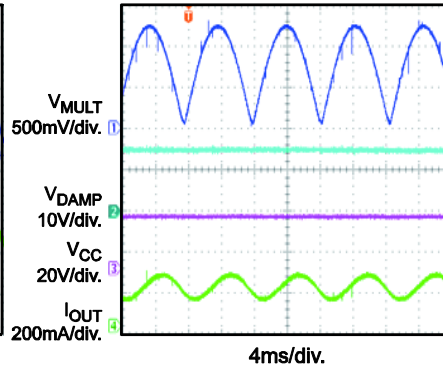
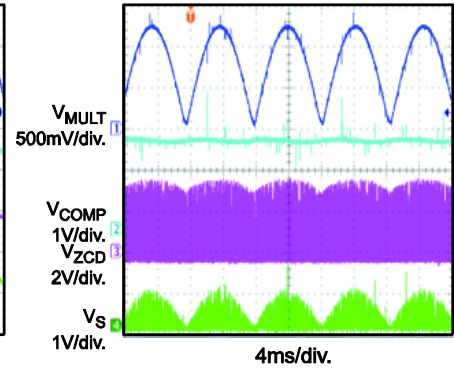
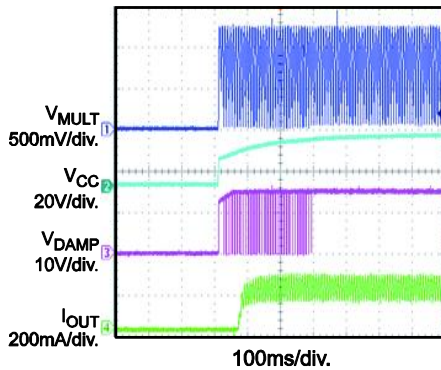
**Steady State**
 $V_{IN}=120V_{AC}/60Hz$ , Full Load

**Steady State**
 $V_{IN}=120V_{AC}/60Hz$ , Full Load

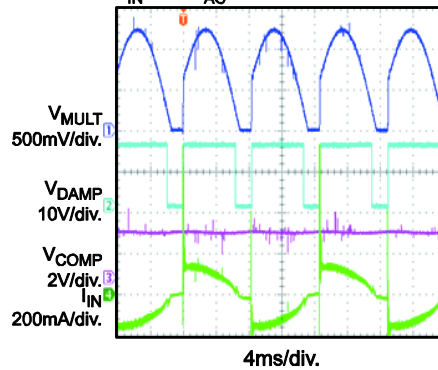
**Steady State**
 $V_{IN}=120V_{AC}/60Hz$ , Full Load

 **$V_{IN}$  Start-Up**
 $V_{IN}=120V_{AC}/60Hz$ , Full Load

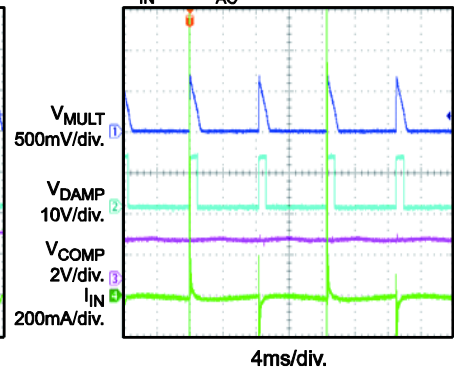
**Dimming Performance**

 Max Dmming on Phase  
with Leading-Edge Dimmer

 $V_{IN}=120V_{AC}/60Hz$ 

**Dimming Performance**

 Min Dmming on Phase  
with Leading-Edge Dimmer

 $V_{IN}=120V_{AC}/60Hz$ 

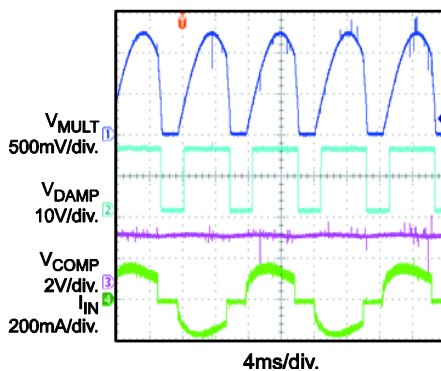
**Dimming Performance**

 Max Dmming on Phase  
with Trailing-Edge Dimmer

 $V_{IN}=120V_{AC}/60Hz$ 

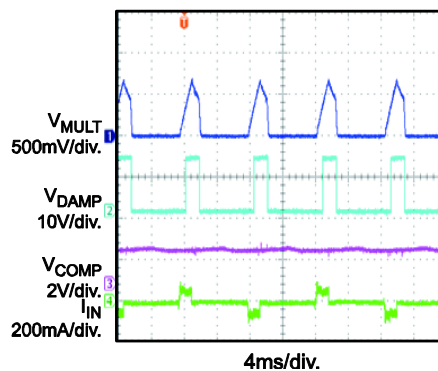
**Dimming Performance**

 Min Dmming on Phase  
with Trailing-Edge Dimmer

 $V_{IN}=120V_{AC}/60Hz$ 

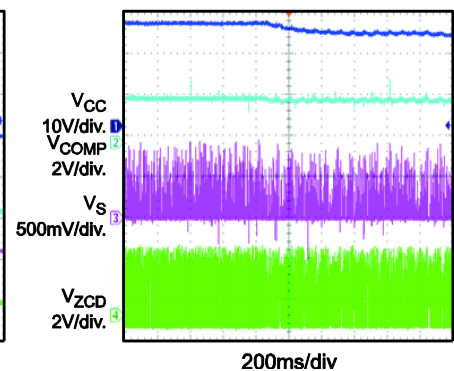
**OVP**

LED Load Open

 $V_{IN}=120V_{AC}/60Hz$ , Full Load

**EVB TEST RESULTS** *(continued)*

Performance waveforms are tested on the evaluation board.

 $V_{IN}=120V_{AC}/60Hz$ , 16 LEDs in series,  $I_{LED}=200mA$ ,  $V_{OUT}=50V$ .
