



The Future of Analog IC Technology®

# EV4057A-K-00A

198VAC~265VAC/50Hz, 21V/370mA+3.3V/50mA  
Single-Stage, Single-Chip Solution for Smart LED

## DESCRIPTION

The EV4057A-K-00A Evaluation Board is designed to demonstrate the capabilities of MP4057A. The MP4057A is a single stage single chip solution for smart LED application. It can regulate the LED current with PSR control and meanwhile to supply power for MCU/wireless module. It is an ideal solution for smart LED lighting because of simplest design, fewest external components and lowest cost.

The EV4057A-K-00A adopts the Flyback topology to drive a 21V LED and supply a 3.3V/50mA smart control module. Its specification lists below.

Determined by the customer specification about the standby power, the EV4057A-K-00A can be configured two kinds of circuits. The default EVB board is designed for less than 30mW standby power, as Fig1 shows. It can also be configured as 15mW standby power as Fig2 shows

## ELECTRICAL SPECIFICATION

Parameter	Symbol	Value	Units
Input Voltage	V <sub>IN</sub>	198 to 265	VAC
LED Voltage	V <sub>OUT</sub>	21	V
LED Current	I <sub>LED</sub>	370	mA
Output Power	P <sub>OUT</sub>	8	W
Vo Voltage	V <sub>o</sub>	3.3	V
Vo Current	I <sub>o</sub>	50	mA

## FEATURES

- Single stage/single chip solution
- Ultra low standby power
- Fast start up
- 5% deep dimming
- No flicker
- Low audible noise
- Valley switching mode for good efficiency
- High Power Factor(typical>0.9)
- Good transient response
- Cycle by cycle current limit in CV operation
- Primary side over current protection
- Output OCP/OVP
- Under voltage lockout(UVLO)
- Thermal shutdown(160°C/100°C)
- MSOP-10/SOIC-14 packages

## APPLICATIONS

- LED lighting with Zigbee/Bluetooth control
- DALI, DMAX, etc. smart lighting

All MPS parts are lead-free, halogen free, and adhere to the RoHS directive. For MPS green status, please visit MPS website under Quality Assurance.

"MPS" and "The Future of Analog IC Technology" are Registered Trademarks of Monolithic Power Systems, Inc.



**Warning:** Although this board is designed to satisfy safety requirements, the engineering prototype has not been agency approved. Therefore, all testing should be performed using an isolation transformer to provide the AC input to the prototype board.

**EV4057A-K-00A EVALUATION BOARD**

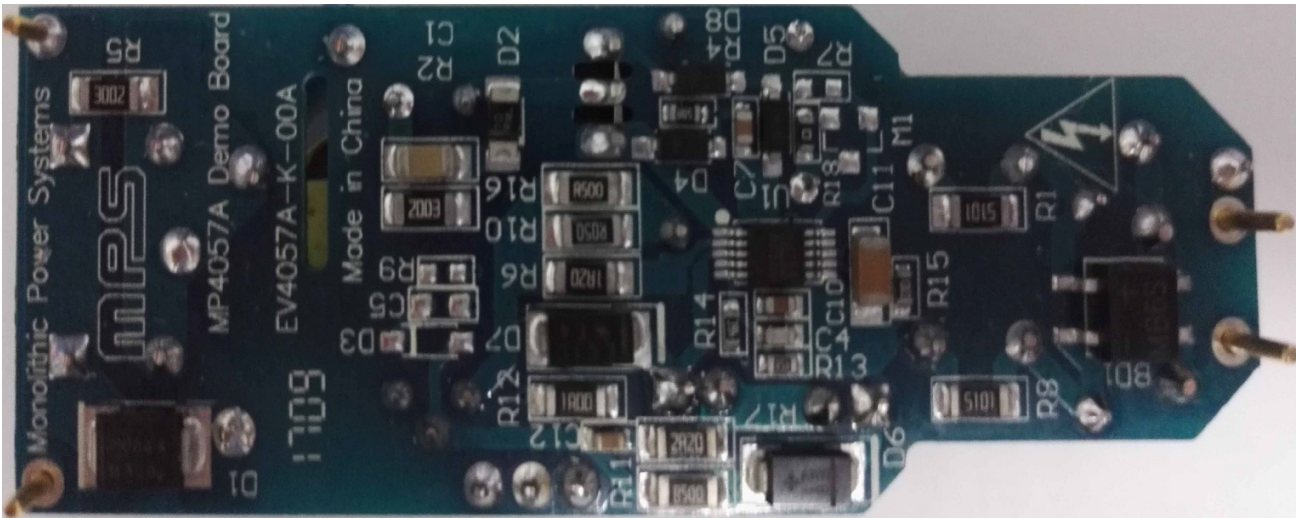

(L x W x H) 66mm x 25mm x 15mm

Board Number	MPS IC Number
EV4057A-K-00A	MP4057AGK

EVALUATION BOARD SCHEMATIC

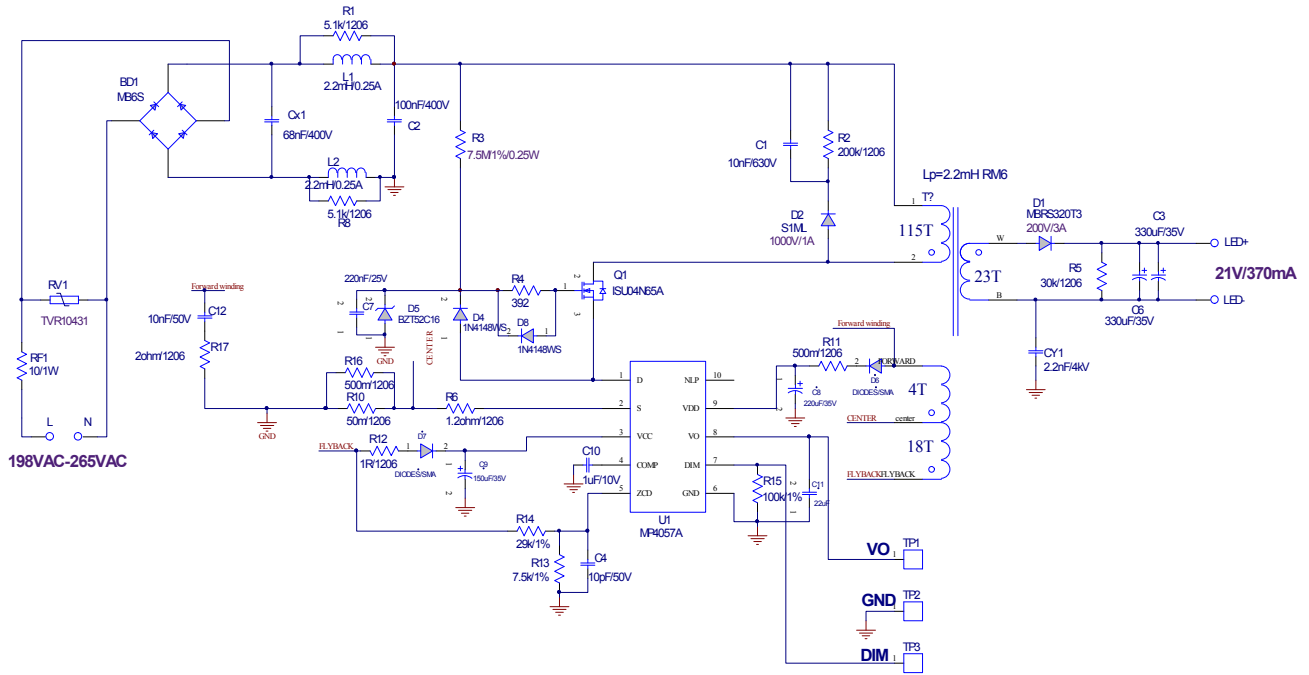

Figure 1—EV4057A-K-00A with 30mW Standby Power

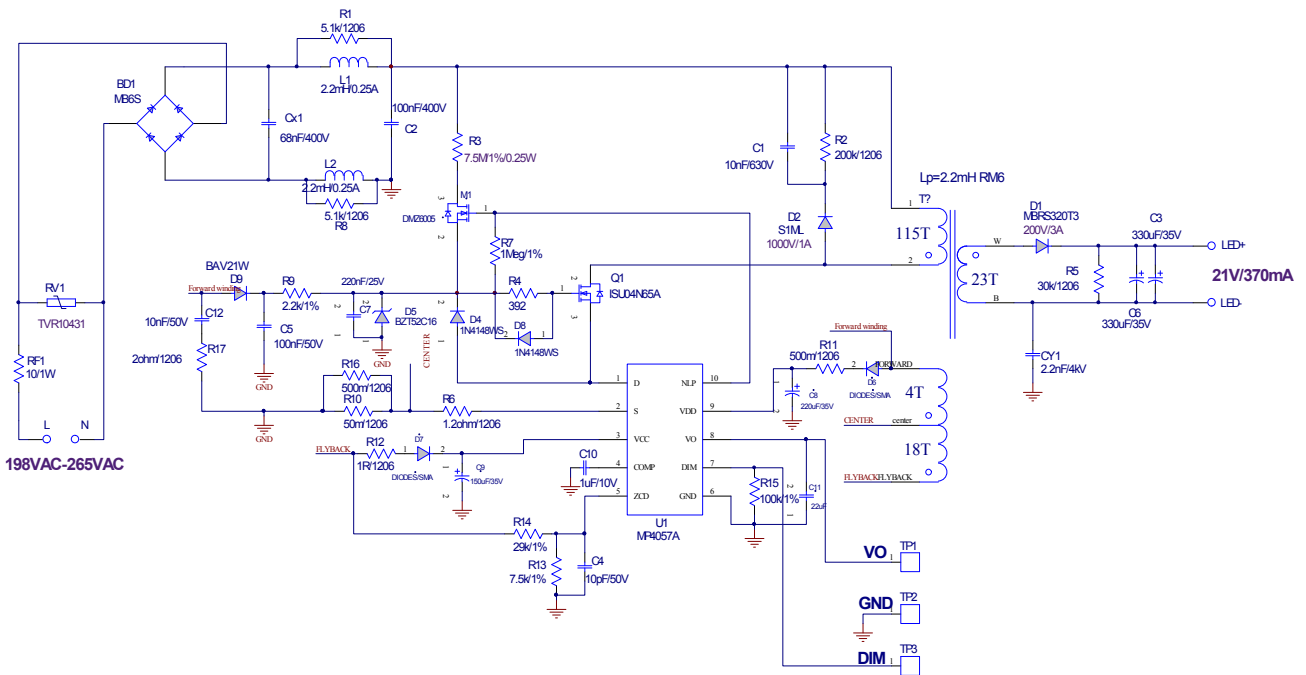
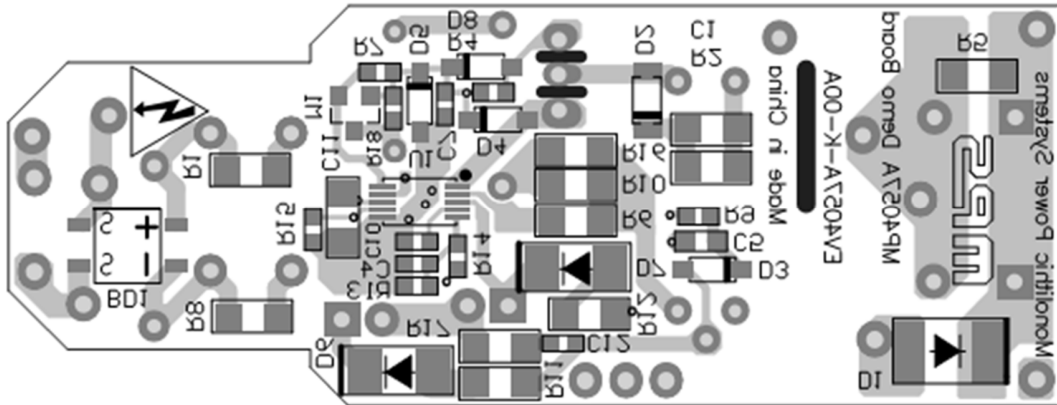
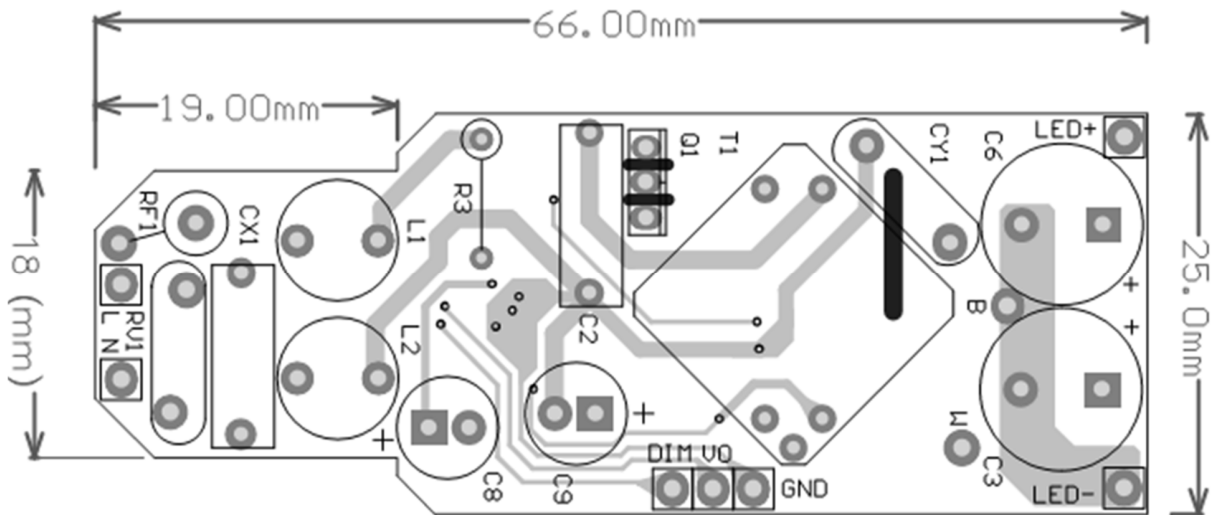

Figure 2—EV4057A-K-00A with 15mW Standby Power

PCB LAYOUT (SINGLE-SIDED)



Bottom layer



Top layer

## CIRCUIT DESCRIPTION

The EV4057A-K-00A is configured as a single-stage Flyback topology and gets a cost effective BOM.

FR1, RV1, BD1, CX1, C2, L1 and L2 compose the input stage. The fusible resistor FR1 fuses the AC input to protect for the component failure or some excessive short event. RV1 is used for surge test. CX1, C2, L1 and L2 form an EMI filter. The diode rectifier BD1 rectifies the input line voltage.

C1, R2 and D2 are used as the RCD snubber network to absorb the voltage spike of the main mosfet Q1.

R3, C7 and D5 are used to startup and bias the gate of the Q1. R12, D7 and C9 are used to supply the power of VCC. R11, D8 and C6 are used to supply the power of VDD.

R14, R13 and C4 are used to sense the Zero current point to achieve valley switching and also used for OVP and brown out detection.

R6, R10 and R16 are sensing resistors for LED current control.

C12 and R17 are placed for absorbing the voltage ringing of the forward winding to achieve better EMI.

R15 is used to set the CV mode as the default operation.

C10 is the compensation network of the control loop.

C11 can filter the noise and ripple of Vo. Without C11, the chip may not work.

Diode D1 is the rectifier diode. The capacitor C3 and C6 are the output filter. The resistor R5 is placed as a dummy load to consume the output power in open load condition.

M1 and R7 are used to achieve 15mW standby power. D9, C5 and R9 are placed for bias the gate of Q1 due to R3 is cut off from AC bus line.

**EV4057A-K-00A BILL OF MATERIALS**

Qty	Ref	Value	Description	Package	Manufacturer	Part Number
1	BD1	MB6S	Rectifier Bridge, 600V, 0.5A	SOIC-4	Taiwan Semi	MB6S
1	C1	10nF/630V	Ceramic Cap, 630V,X7R	1206	Murata	GRM31BR72J103KW01L
1	CX1	68nF/400V	CBB, 400V	DIP	FARA	C222G683K30C000
1	C2	100nF/400V	CBB, 400V	DIP	Panasonic	ECQE4104KF
2	C3, C6	330µF/35V	Electrolytic Capacitor, 35V	DIP	Jianghai	CD263-35V330
1	C4	10pF/50V	Ceramic Cap, 50V,COG	0603	Murata	GRM1885C1H100JA01
1	C7	220nF/50V	Ceramic Cap,50V,X7R	0603	TDK	C1608X7R1H224K
1	C8	220µF/25V	Electrolytic Capacitor, 25V	DIP	Ymin	LKM_25V_220u_6.3*11
1	C9	150µF/35V	Electrolytic Capacitor, 35V	DIP	Ymin	LKM_35V_150u_6.3*11
1	C10	1µF/10V	Ceramic Cap,10V,X7R	0603	Murata	GRM188R71A105KA61D
1	C11	22µF/6.3V	Ceramic Cap, 6.3V,X7R	1206	Murata	GRM31CR70G226KE19L
1	C12	10nF/50V	Ceramic Cap,50V,X7R	0603	Murata	GRM188R71H103JA01D
1	CY1	2.2nF	Y Capacitor,4000V	DIP	Hongke	JNK12E222MY02N
1	D1	MBRS3200T3G	Schottky Diode, 200V, 3A	SMB	ON Semi	MBRS3200T3G
1	D2	WSGC10MH	Diode, 1A, 1kV	1206	Zowie	WSGC10MH
1	D4	1N4148W	Diode, 0.15A, 75V	SOD- 123	Diodes	1N4148W
1	D8	1N4148W	Diode, 0.15A, 75V	SOD- 123	Diodes	1N4148W
1	D5	BZT52C18	Zener Diode, 18V, 500mW	SOD- 123	Diodes	BZT52C18
1	D6	ES1B	Diode, 1A, 100V	SMA	Vishay	ES1B-E3/61T
1	D7	ES1D	200V, 1A	SMA	Taiwan Semi	ES1D
2	L1, L2	2.2mH	DM inductor	DIP	TDK	TSL1112RA-222JR33
1	Q1	SVF2N60	N-Channel Mosfet; 600V;	To-251	SILAN	SVF2N60
2	R1, R8	5.1kΩ	Thick Film Chip RES, 5%	1206	Yageo	
1	R2	200kΩ	Thick Film Chip RES, 5%	1206	Yageo	
1	R3	7.5M	Metal Film RES, 1/4W, 1%	DIP	Any	
1	R4	392ohm	Thick Film Chip RES, 1%	0603	Yageo	

**EV4057A-K-00A BILL OF MATERIALS (continued)**

Qty	Ref	Value	Description	Package	Manufacturer	Part Number
1	R5	30kΩ	Film RES, 1%	1206	Yageo	
1	R6	1.2Ω	Thick Film Chip RES, 1%	1206	Yageo	
1	R10	50mΩ	Thick Film Chip RES, 1%	1206	Yageo	
1	R11	500mΩ	Thick Film Chip RES, 1%	1206	Yageo	
1	R12	1Ω	Thick Film Chip RES, 1%	1206	Yageo	
1	R13	7.5k/1%	Thick Film Chip RES, 1%	0603	Yageo	
1	R14	29.4k/1%	Thick Film Chip RES, 1%	0603	Yageo	
1	R15	100k/1%	Thick Film Chip RES, 1%	0603	Yageo	
1	R16	500m/1206	Thick Film Chip RES, 1%	1206	Yageo	
1	R17	2.2ohm/1206	Thick Film Chip RES, 1%	1206	Yageo	
1	R18	0Ω	Thick Film Chip RES, 1%	0603	Yageo	
1	RF1	10/0.5W	Fuse resistor	DIP		
1	RV1	430V/2500A	MOV	DIP	TKS	TVR10431KSY
1	T1	2.2mH	RM6/2.2mH/115:23:18:4	DIP	EMEI	FX0474
1	U1	MP4057AGS	Smart LED lighting controller with MCU power supply	MSOP-10	MPS	MP4057AGS

**TRANSFORMER SPECIFICATION**

**Electrical Diagram**

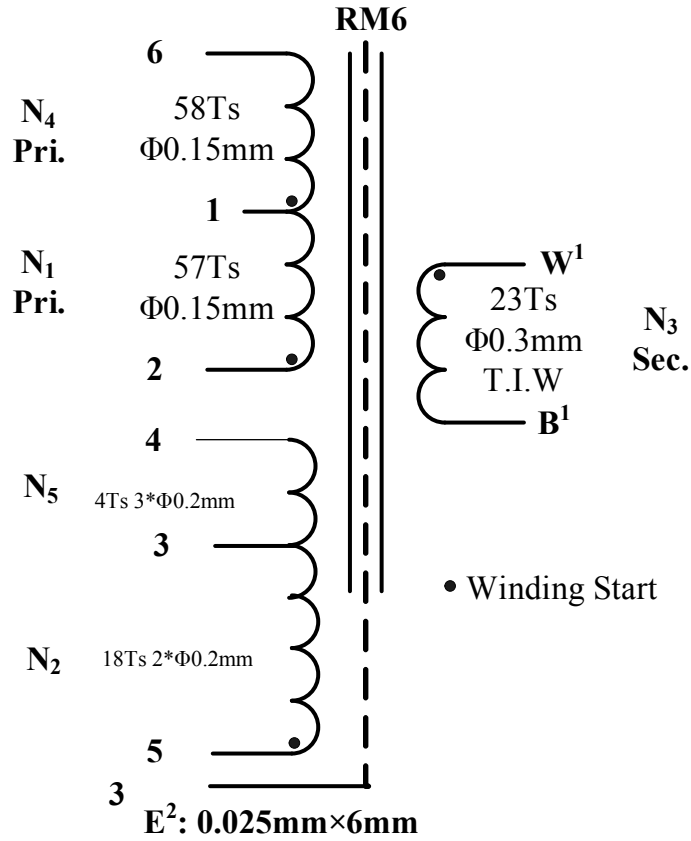

Figure 3—Transformer Electrical Diagram

**Winding Diagram**

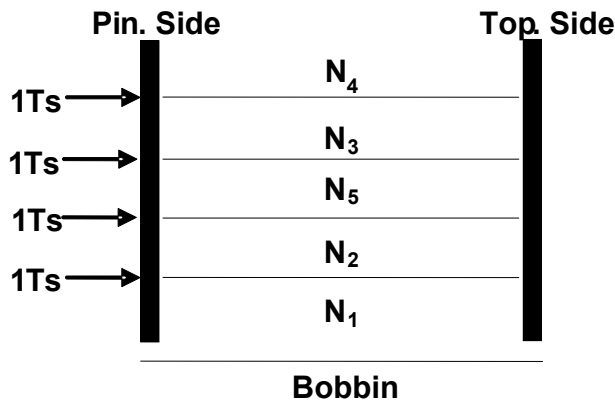

Figure 4—Winding Diagram



**Winding Order**

Tape Layer Number	Winding No.	Start & End	Magnet Wire $\phi$	Turns	Remark	Teflon Tube
1	N <sub>1</sub>	2—> 1	0.15*1(AWG)	58		
1	N <sub>2</sub>	5—> 3	0.2*2(AWG)	18	well-distributed in one layer	Matching with wire
1	N <sub>5</sub>	3—> 4	0.2*3(AWG)	4		Matching with wire
1	N <sub>3</sub>	W—> B	0.3*1 (AWG T.I.W)	23		
2	N <sub>4</sub>	1—> 6	0.15*1(AWG)	57		

**Electrical Specifications**

<b>Electrical Strength</b>	60 second, 60Hz, from Winding to CORE.	3000VAC
<b>Primary Inductance</b>	Pins 2- 6, all other windings open, measured at 60kHz, 0.1 VRMS	2.2mH $\pm$ 8 %

## EVB TEST RESULTS

### Performance Data

#### Efficiency, PF and THD

<i>f</i> (Hz)	V <sub>in</sub> (V)	P <sub>in</sub> (W)	V <sub>LED</sub> (V)	I <sub>LED</sub> (mA)	P <sub>o</sub> (W)	Efficiency (%)	PF	THD(%)
50	198	8.8	20.68	367	7.59	86.25	0.953	15.4
	230	8.85	20.64	368	7.6	85.83	0.928	16.8
	265	8.95	20.64	371	7.66	85.56	0.897	17.6

#### Dimming Performance(Test@230Vac, 7LED output)

I <sub>LED</sub> (mA)	200Hz	1kHz	5kHz
0	0	0	0
1%	19	20	20
2%	22	22	23
3%	26	26	26
4%	30	30	31
5%	34	34	34
6%	37	37	38
7%	40	40	41
8%	44	44	44
9%	48	48	48
10%	51	51	51
20%	86	86	86
30%	122	122	122
40%	157	157	157
50%	192	192	193
60%	228	227	228
70%	263	263	263
80%	298	298	298
90%	333	333	333
100%	369	369	368

### EVB TEST RESULTS

Performance waveforms are tested on the evaluation board.

$V_{IN}=230VAC/50Hz$ , 7LEDs in series,  $I_{LED}=370mA$ ,  $V_{LED}=21V$ ,  $L_p=2.2mH$ .

**Line Regulation**

$V_{IN}=(198-265)Vac/50Hz$ , Full Load

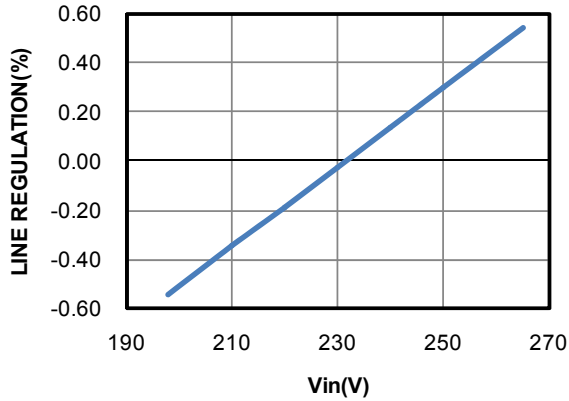

**Load Regulation**

$V_{IN}=(198-265)Vac/50Hz$ , Full Load

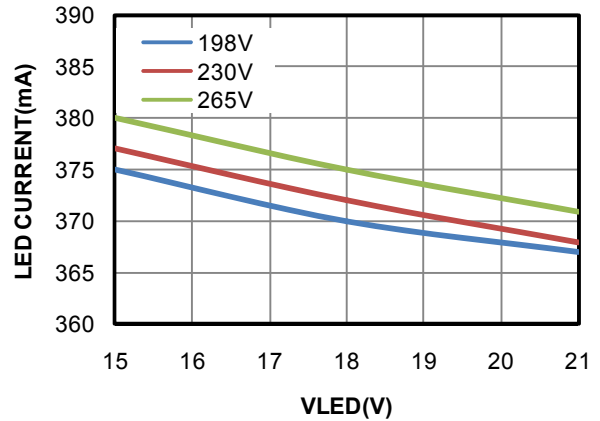

**Efficiency**

$V_{IN}=(198-265)Vac/50Hz$ , Full Load

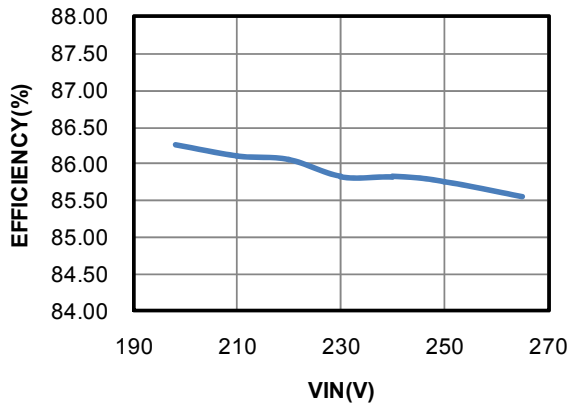

**PF**

$V_{IN}=(198-265)Vac/50Hz$ , Full Load

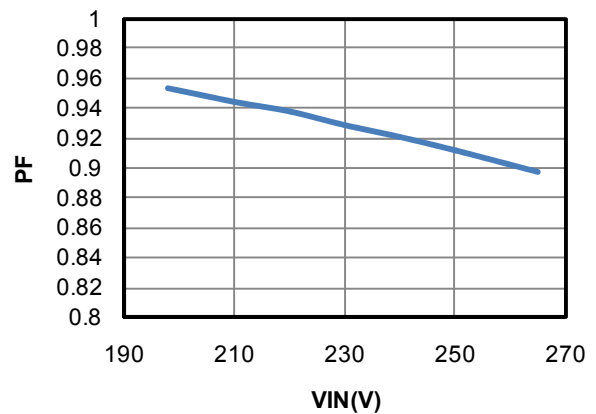

**THD**

$V_{IN}=(198-265)Vac/50Hz$ , Full Load

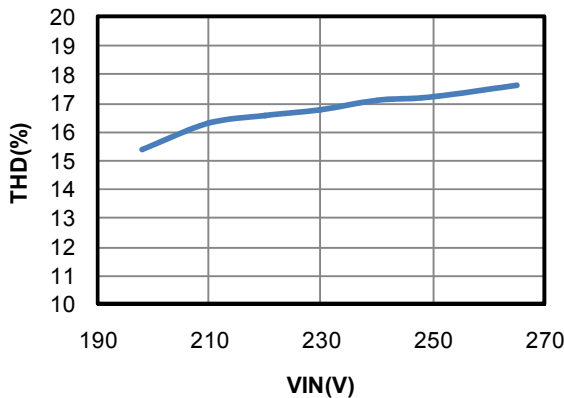

**Dimming Curve**

$V_{IN}=230Vac$ , 7 LED Output

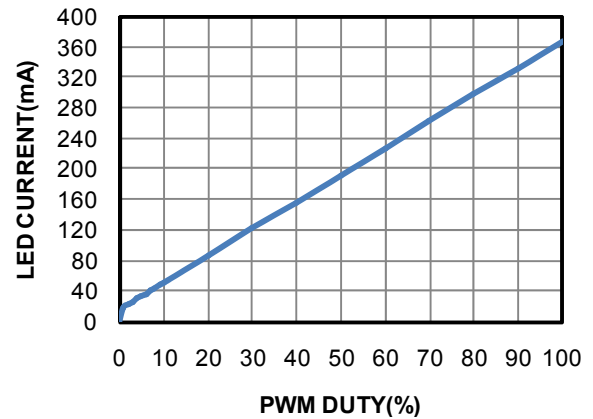

**EVB TEST RESULTS***(continued)*

Performance waveforms are tested on the evaluation board.

$V_{IN}=230VAC/50Hz$ , 7 LEDs in series,  $I_{LED}=370mA$ ,  $V_{LED}=21V$ ,  $L_p=2.2mH$ .

**Conduct EMI-L Line**  
 $V_{IN}=230Vac$ , 7 LED Output

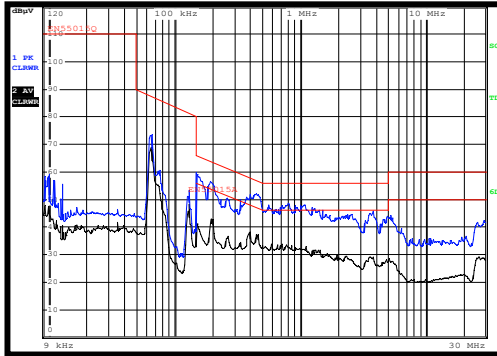

**Conduct EMI-N Line**  
 $V_{IN}=230Vac$ , 7 LED Output

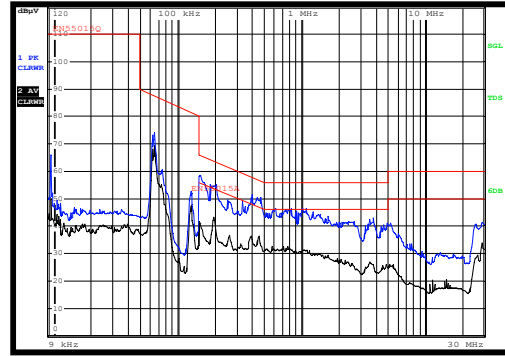

**CDN**  
 $V_{IN}=230Vac$ , 7 LED Output

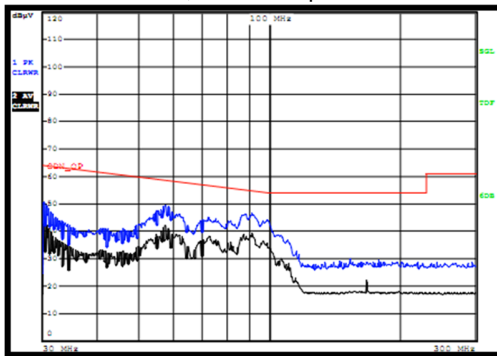

**EVB TEST RESULTS**(continued)

Performance waveforms are tested on the evaluation board.

$V_{IN}=230VAC/50Hz$ , 7 LEDs in series,  $I_{LED}=370mA$ ,  $V_{LED}=21V$ ,  $L_p=2.2mH$ .

**Steady State**

$V_{IN}=230Vac$ , 7 LED Output

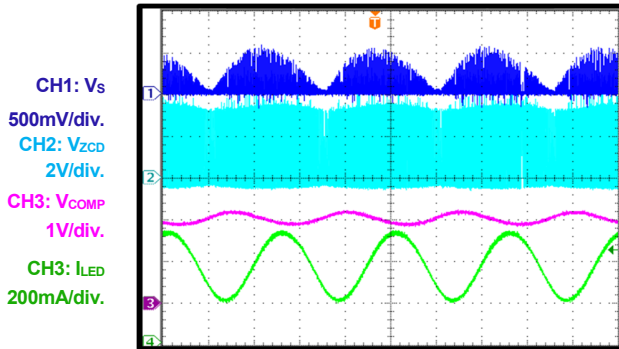

4ms/div.

**Steady State**

$V_{IN}=230Vac$ , 7 LED Output

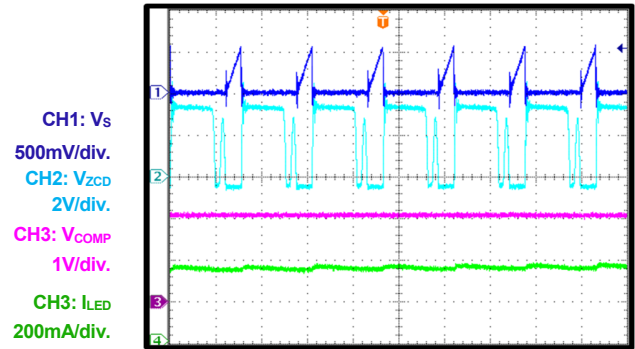

10µs/div.

**Steady State**

$V_{IN}=230Vac$ , 7 LED Output

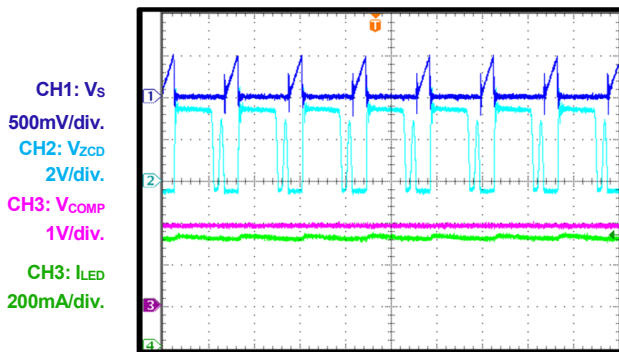

10µs/div.

**Start-Up**

$V_{IN}=230Vac$ , 7 LED Output

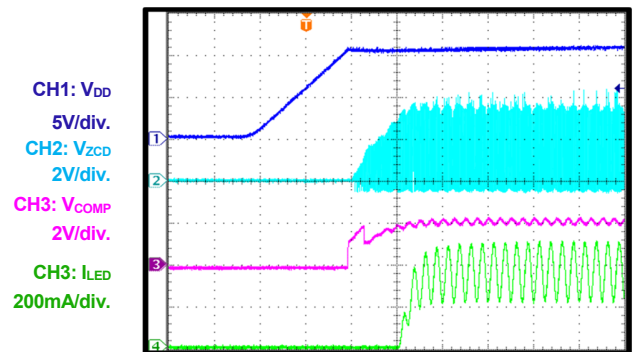

40ms/div.

**Shutdown**

$V_{IN}=230Vac$ , 7 LED Output

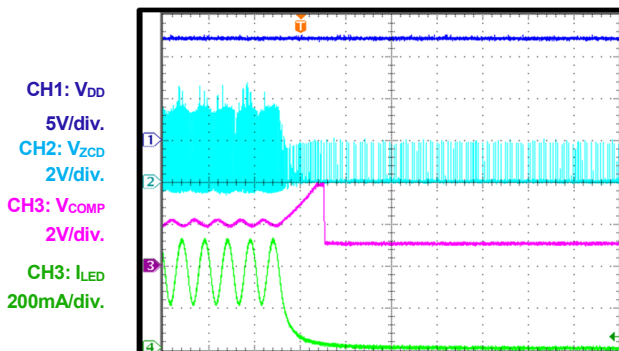

20ms/div.

**CV-CC**

$V_{IN}=230Vac$ , 7 LED Output, Full Load

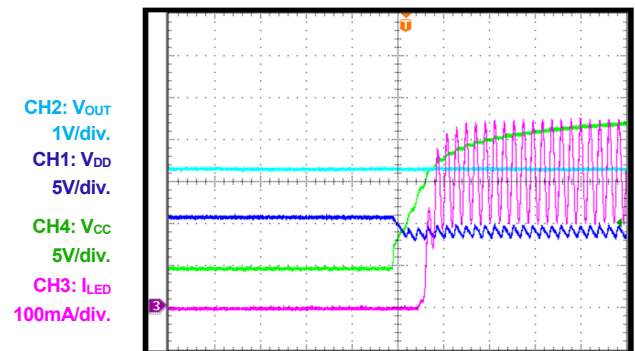

40ms/div.

**EVB TEST RESULTS**(continued)

Performance waveforms are tested on the evaluation board.

$V_{IN}=230VAC/50Hz$ , 7 LEDs in series,  $I_{LED}=370mA$ ,  $V_{LED}=21V$ ,  $L_p=2.2mH$ .

**CC-CV**

$V_{IN}=230Vac$ , 7 LED Output, Full Load

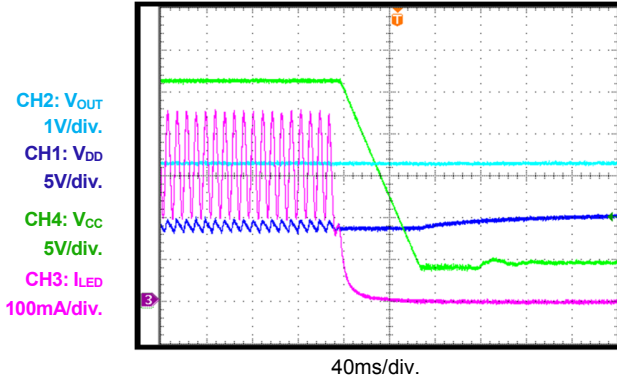

**CV-CC**

$V_{IN}=230Vac$ , 7 LED Output, DIM=1%

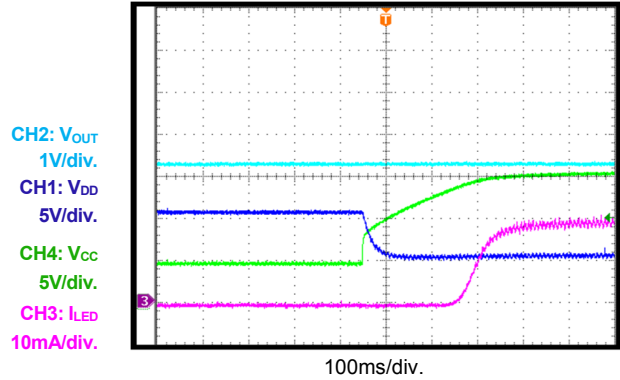

**CC-CV**

$V_{IN}=230Vac$ , 7 LED Output, DIM=1%

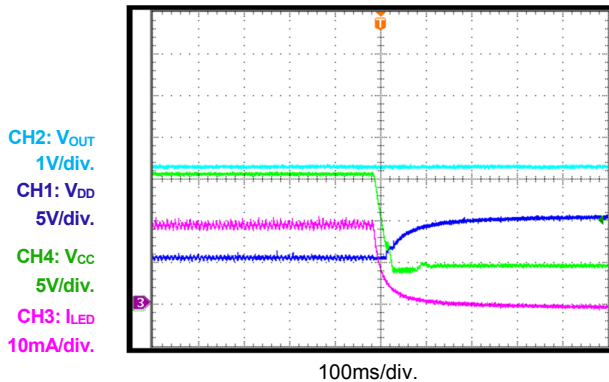

**OVP**

$V_{IN}=230Vac$ , 7 LED Output

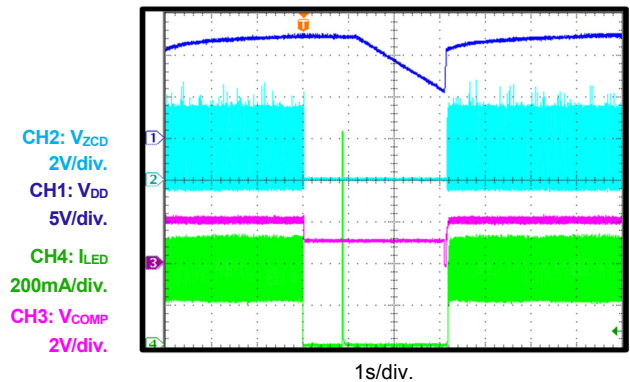

**SCP**

$V_{IN}=230Vac$ , 7 LED Output

