



The Future of Analog IC Technology®

EV4059-S-00A

90VAC~265VAC, 21V/350mA
Single-Stage Deep PWM Dimming Solution

DESCRIPTION

The EV4059-S-00A Evaluation Board is designed to demonstrate the capabilities of MP4059. The MP4059 is a single power stage and PFC controller targeting at LED deep dimming applications. It can regulate a constant current to an LED load over a 1% to 100% dimming range without flicker or shimmer. It is a primary side controller without any secondary side feedback components and the opto-coupler to significantly simplify LED driver design. The MP4059 integrates power factor correction and works in valley switching mode to achieve high efficiency.

The EV4059-S-00A adopts the Flyback topology to drive a 21V LED. Its specification lists below.

ELECTRICAL SPECIFICATION

Parameter	Symbol	Value	Units
Input Voltage	V_{IN}	90 to 265	VAC
LED Voltage	V_{OUT}	21	V
LED Current	I_{LED}	350	mA

FEATURES

- 1% to 100% dimming range
- Ultra low standby loss, typically less than 50mW at 230Vac.
- Universal input
- Fast start up
- No flicker
- Low audible noise
- Valley switching mode for good efficiency
- Good PF(typically >0.9)
- Primary-side Over-Current protection
- Output OVP/SCP
- Under-voltage lockout(UVLO)
- Thermal Shutdown (160°C/100°C)
- SOIC-8 Package

APPLICATIONS

- LED PWM dimming

All MPS parts are lead-free, halogen free, and adhere to the RoHS directive. For MPS green status, please visit MPS website under Quality Assurance.

“MPS” and “The Future of Analog IC Technology” are Registered Trademarks of Monolithic Power Systems, Inc.



High Voltage

Warning: Although this board is designed to satisfy safety requirements, the engineering prototype has not been agency approved. Therefore, all testing should be performed using an isolation transformer to provide the AC input to the prototype board.

EV4059-S-00A EVALUATION BOARD

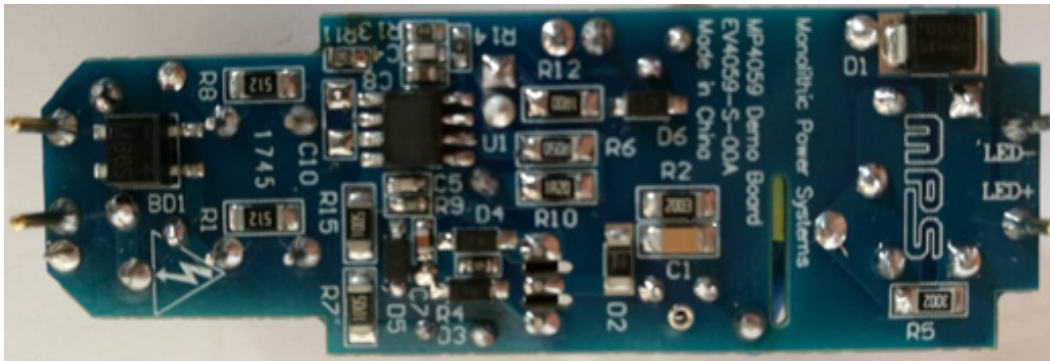

(L x W x H) 66mm x 22.5mm x 15mm

Board Number	MPS IC Number
EV4059-S-00A	MP4059GS

EVALUATION BOARD SCHEMATIC

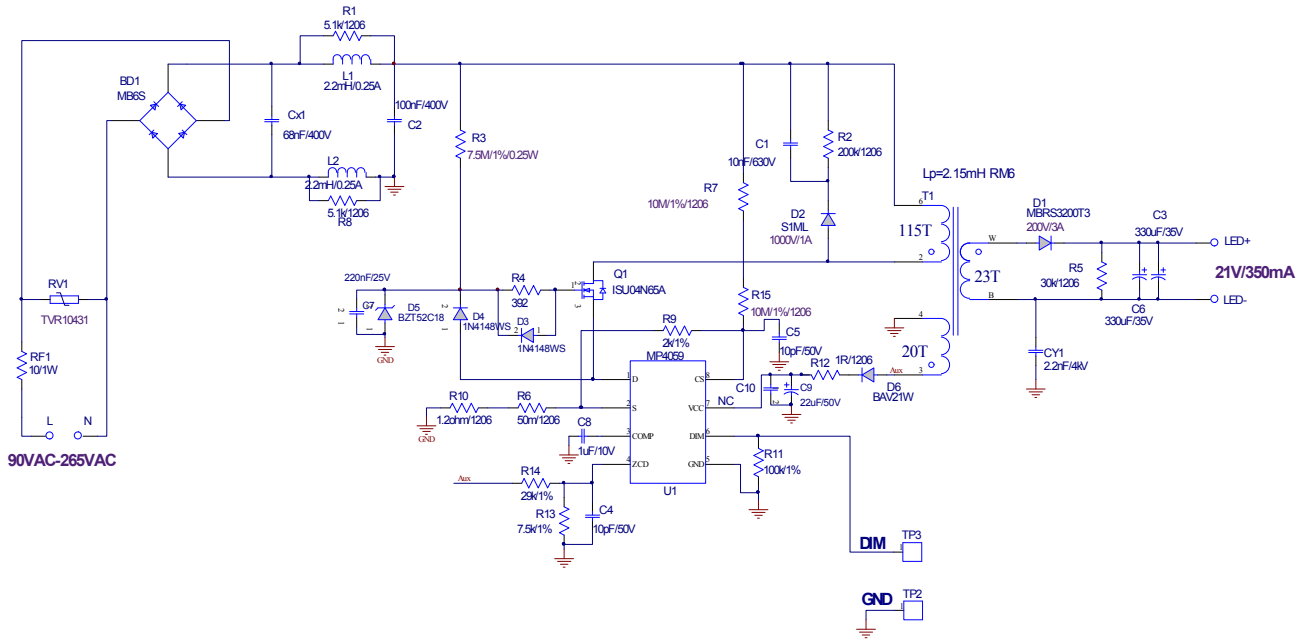
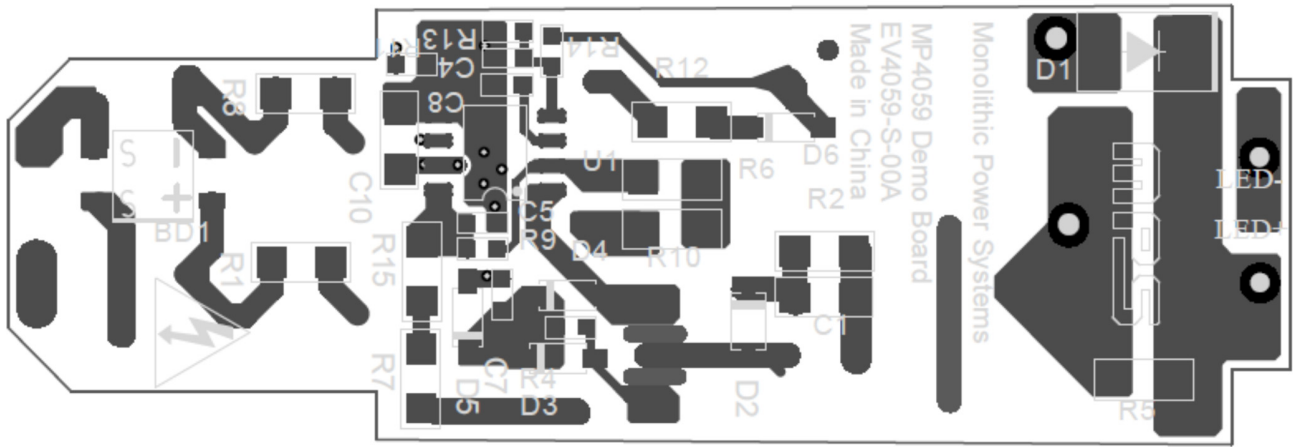
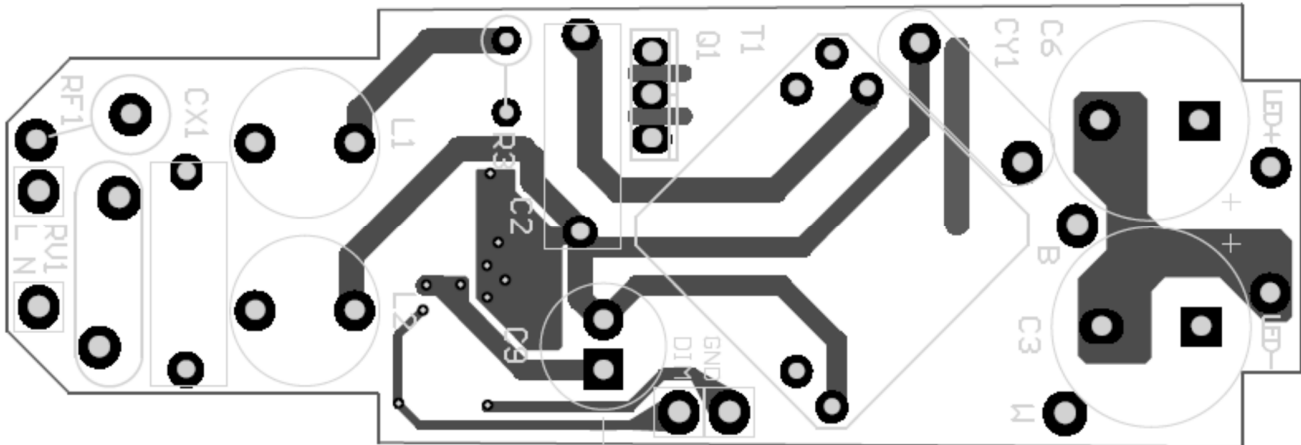

Figure 1—EV4059-S-00A

PCB LAYOUT



Bottom layer



Top layer

CIRCUIT DESCRIPTION

The EV4059-S-00A is configured as a single-stage Flyback topology and gets a cost effective BOM.

RF1, RV1, BD1, CX1, C2, L1 and L2 compose the input stage. The fusible resistor RF1 fuses the AC input to protect for the component failure or some excessive short event. RV1 is used for surge test. CX1, C2, L1 and L2 form an EMI filter. The diode rectifier BD1 rectifies the input line voltage.

C1, R2 and D2 are used as the RCD snubber network to absorb the voltage spike of the main MOSFET Q1.

R3, C7 and D5 are used to startup and bias the gate of the Q1. R12, D6, C10 and C9 are used to supply the power of VCC.

R14, R13 and C4 are used to sense the Zero current point to achieve valley switching and also used for OVP and brown out detection.

R6 and R10 are sensing resistors for LED current control. R7, R9, R15 and C5 compose the compensation circuit; select a proper R9 to get good line regulation. R11 is used to set the CV mode as the default operation.

C8 is the compensation network of the control loop.

Diode D1 is the rectifier diode. The capacitor C3 and C6 are the output filter. The resistor R5 is placed as a dummy load to consume the output power in open load condition.

Remove R11 in DIM pin, the chip works in CC mode. When PWM signal is applied, the R11 should be connected. The chip works in CV mode, when R11 is connected and no PWM signal input.

D4 is used to clamp the voltage of D pin into a safe range.

EV4059-S-00A BILL OF MATERIALS

Qty	RefDes	Value	Description	Package	Manufacture	Manufacture_PN
1	BD1	MB6S	Rectifier Bridge, 600V, 0.5A	SOIC-4	Taiwan Semi	MB6S
1	C1	10nF/630V	Ceramic Cap, 630V,X7R	1206	Murata	GRJ31BR72J103KWJ1L
1	CX1	68nF/400V	CBB, 400V	DIP	FARA	C222G683K30C000
1	C2	100nF/400V	CBB, 400V	DIP	Panasonic	ECQE4104KF
2	C3, C6	330µF/35V	Electrolytic Capacitor, 35V	DIP	Jianghai	CD263-35V330
2	C4,C5	10pF/50V	Ceramic Cap, 50V,COG	0603	Murata	GRM1885C1H100JA01
1	C7	220nF/50V	Ceramic Cap, 50V,X7R	0603	TDK	C1608X7R1H224K
1	C8	1µF/10V	Ceramic Cap, 10V,X7R	0603	Murata	GRM188R71A105KA61D
1	C9	22µF/50V	Electrolytic Capacitor, 50V	DIP	Wurth	860160672011
0	C10	NC				
1	CY1	2.2nF	Y Capacitor, 4000V	DIP	Hongke	JNK12E222MY02N
1	D1	MBRS3200T3G	Schottky Diode, 200V, 3A	SMB	ON Semi	MBRS3200T3G
1	D2	WSGC10MH	Diode, 1A, 1kV	1206	Zowie	WSGC10MH
2	D3,D4	1N4148W	Diode, 0.15A, 75V	SOD-123	Diodes	1N4148W
1	D5	BZT52C18	Zener Diode, 18V, 500mW	SOD-123	Diodes	BZT52C18
1	D6	BAV21W	Diode	SOD-124	Diodes	BAV21W
2	L1, L2	2.2mH	DM inductor	DIP	Wurth	7447720222
1	Q1	ISU04N65A	N-Channel Mosfet;650V;	To-251	IPS	ISU04N65A
2	R1, R8	5.1kΩ	Thick Film Chip RES, 5%	1206	Yageo	RC1206JR-075K1L
1	R2	200kΩ	Thick Film Chip RES, 5%	1206	Yageo	RC1206FR-07200KL
1	R3	7.5M	Metal Film RES, 1/4W, 1%	DIP	Any	
1	R4	392ohm	Thick Film Chip RES, 1%	0603	Yageo	RC0603FR-07392RL
1	R5	30kΩ	Film RES, 1%	1206	Yageo	RC1206FR-0730KL
1	R6	50mΩ	Thick Film Chip RES, 1%	1206	Yageo	RL1206FR-070R5L
2	R7,R15	10M	Thick Film Chip RES, 5%	1206	Yageo	RC1206FR-0710ML
1	R9	2k/1%	Thick Film Chip RES, 1%	0603	Yageo	RC0603FR-072KL
1	R10	1.2Ω	Thick Film Chip RES, 1%	1206	Yageo	RC1206FR-071R2L
1	R11	100k/1%	Thick Film Chip RES, 1%	0603	Yageo	RC0603JR-07100KL

EV4059-S-00A BILL OF MATERIALS

Qty	RefDes	Value	Description	Package	Manufacture	Manufacture_PN
1	R12	1Ω	Thick Film Chip RES, 1%	1206	Yageo	RC1206FR-071RL
1	R13	7.5k/1%	Thick Film Chip RES, 1%	0603	Yageo	RC0603FR-077K5L
1	R14	29.4k/1%	Thick Film Chip RES, 1%	0603	Yageo	RC0603FR-0729K4L
1	RF1	10/1W	Fuse resistor	DIP		
1	RV1	430V/2500A	MOV	DIP	TKS	TVR10431KSY
1	T1	2.15mH	RM6/2.15mH /115:23:20	DIP	YiMei	
1	U1	MP4059GS	Smart LED lighting controller with MCU power supply	MSOP-10	MPS	MP4059GS
1	TP2	GND	TP			
1	TP3	DIM	TP			
4	L, LED+, LED-, N		Connector;			

TRANSFORMER SPECIFICATION

Electrical Diagram

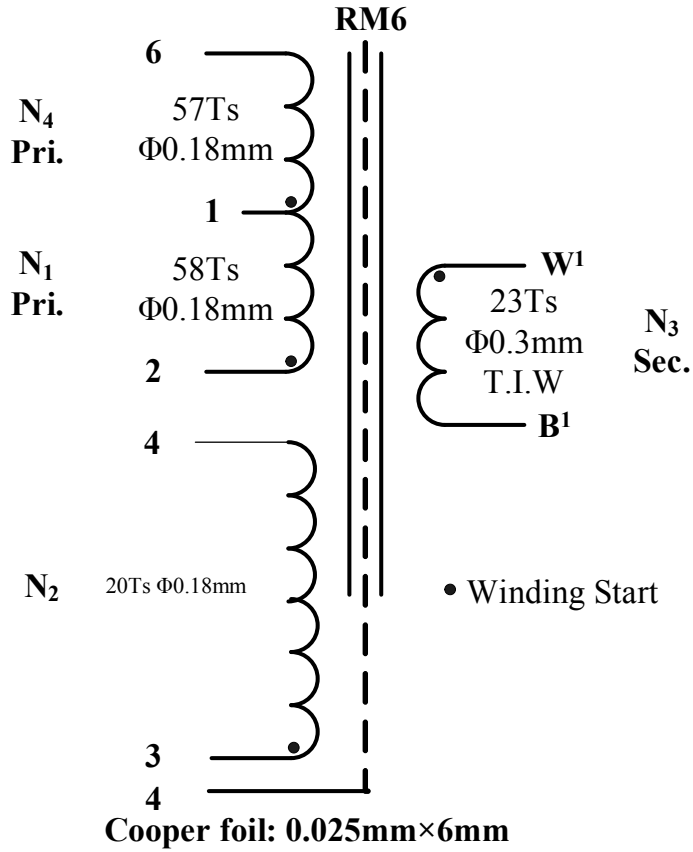

Figure 3—Transformer Electrical Diagram

Winding Diagram

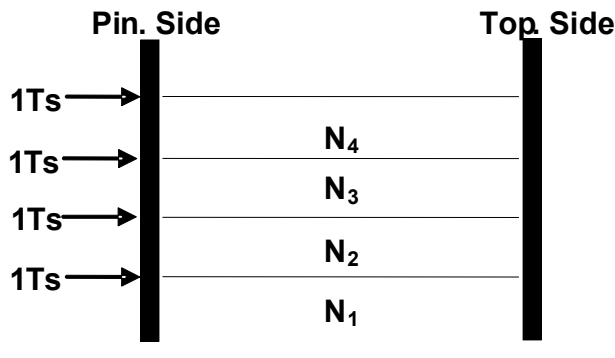

Figure 4—Winding Diagram

Winding Order

Tape Layer Number	Winding No.	Start & End	Magnet Wire ϕ	Turns	Remark	Teflon Tube
1	N ₁	2—> 1	0.18*1(AWG)	58		Matching with wire
1	N ₂	3—> 4	0.18(AWG)	20	well- distributed in one layer	Matching with wire
1	N ₃	W—> B	0.3*1 (AWG T.I.W)	23		Matching with wire
2	N ₄	1—> 6	0.18*1(AWG)	57		Matching with wire

Electrical Specifications

Electrical Strength	60 second, 60Hz, from Winding to CORE.	3000VAC
Primary Inductance	Pins 2- 6, all other windings open, measured at 60kHz, 0.1 VRMS	2.15mH \pm 8%

EVB TEST RESULTS

Performance Data

Efficiency, PF and THD

V _{IN} (VAC)	P _{IN} (W)	V _O (V)	I _{LED} (mA)	P _O (W)	Efficiency (%)	PF	THD (%)
90	8.701	21.05	351	7.38855	84.92%	0.986	0.99
100	8.64	21.05	352.7	7.424335	85.93%	0.983	0.988
110	8.6	21.05	353	7.43065	86.40%	0.98	0.986
120	8.55	21.05	353	7.43065	86.91%	0.976	0.983
130	8.49	21.05	352.8	7.42644	87.47%	0.971	0.98
140	8.44	21.03	352.4	7.410972	87.81%	0.965	0.975
150	8.39	21.02	352.1	7.401142	88.21%	0.959	0.97
160	8.38	21.02	351.8	7.394836	88.24%	0.952	0.964
170	8.37	21.02	351.5	7.38853	88.27%	0.945	0.958
180	8.35	21.01	351.2	7.378712	88.37%	0.937	0.951
190	8.34	21	351	7.371	88.38%	0.932	0.944
198	8.33	21	350.7	7.3647	88.41%	0.928	0.938
210	8.33	21	350.5	7.3605	88.36%	0.923	0.935
220	8.32	20.99	350.2	7.350698	88.35%	0.915	0.929
230	8.32	20.99	350.1	7.348599	88.32%	0.906	0.917
240	8.33	20.99	349.9	7.344401	88.17%	0.896	0.91
250	8.34	20.99	349.8	7.342302	88.04%	0.886	0.904
265	8.35	20.99	349.6	7.338104	87.88%	0.874	0.894

Dimming Performance (Test@7LED output)

220V/5kHz		220V/1kHz		120V/5kHz		120V/1kHz	
Duty(%)	I _{out} (mA)	Duty(%)	I _{out} (mA)	Duty(%)	I _{out} (mA)	Duty(%)	I _{out} (mA)
100	352.4	100	352.3	100	355.5	100	355.5
90	315.9	90	315.6	90	319.1	90	318.6
80	279.3	80	278.9	80	281.9	80	281.5
70	243.1	70	242.8	70	244.7	70	244.3
60	207.4	60	207.1	60	207.5	60	207.1
50	171.9	50	171.6	50	170.4	50	170
40	136.8	40	136.5	40	133.6	40	133.2
30	101.7	30	101.5	30	97.4	30	97
20	66.5	20	66.2	20	62.9	20	62.6
10	31.1	10	31.05	10	29.57	10	29.27
9	27.85	9	27.57	9	26.25	9	25.97
8	24.33	8	24.04	8	22.91	8	22.64
7	20.78	7	20.5	7	19.63	7	19.34
6	17.23	6	16.81	6	16.27	6	15.99

220V/5kHz		220V/1kHz		120V/5kHz		120V/1kHz	
Duty(%)	Iout(mA)	Duty(%)	Iout(mA)	Duty(%)	Iout(mA)	Duty(%)	Iout(mA)
5	13.16	5	13.12	5	12.9	5	12.61
4	9.31	4	8.94	4	9.43	4	9.16
3	5.25	3	4.97	3	5.98	3	5.65
2	3.51	2	3.53	2	1.2	2	0.54
1	3.5	1	3.51	1	0.27	1	0.26
0	0	0	0	0	0	0	0

EVB TEST RESULTS

Performance waveforms are tested on the evaluation board.

$V_{IN}=(90-265)VAC/50Hz$, 7LEDs in series, $I_{LED}=350mA$, $V_{LED}=21V$, $L_p=2.15mH$.

Line Regulation

$V_{IN}=(90-265)Vac/50Hz$, Full Load

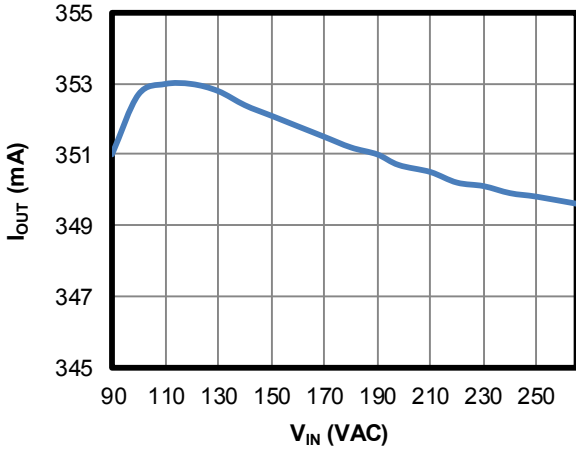

Efficiency

$V_{IN}=(90-265)Vac/50Hz$, Full Load

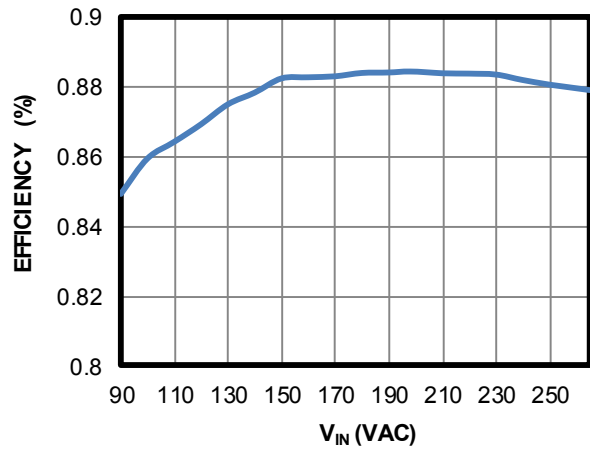

PF

$V_{IN}=(90-265)Vac/50Hz$, Full Load

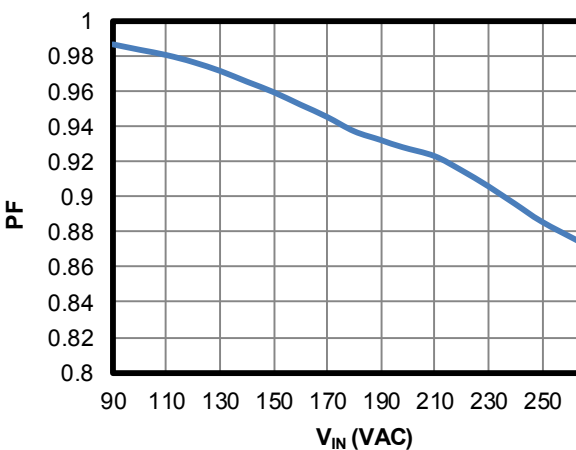

THD

$V_{IN}=(90-265)Vac/50Hz$, Full Load

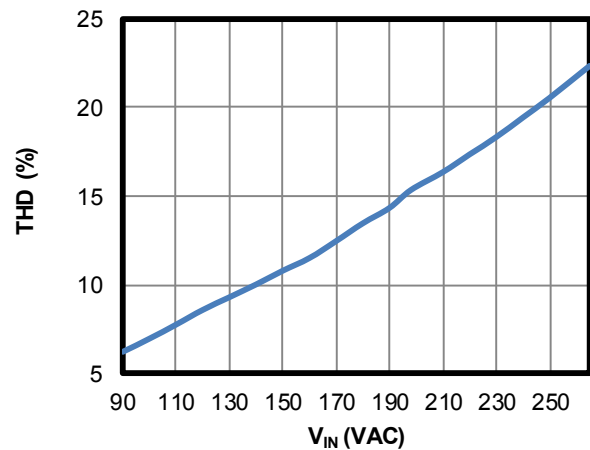

5kHz PWM Dimming Curve

$V_{IN}=220Vac$, 7 LED Output



1kHz PWM Dimming Curve

$V_{IN}=220Vac$, 7 LED Output



EVB TEST RESULTS *(continued)*

Performance waveforms are tested on the evaluation board.

$V_{IN}=(90-265)VAC/50Hz$, 7LEDs in series, $I_{LED}=350mA$, $V_{LED}=21V$, $L_p=2.15mH$.

5kHz PWM Dimming Curve

$V_{IN}=120Vac$, 7 LED Output



1kHz PWM Dimming Curve

$V_{IN}=120Vac$, 7 LED Output



Conduct EMI-L Line

$V_{IN}=120Vac$, 7 LED Output

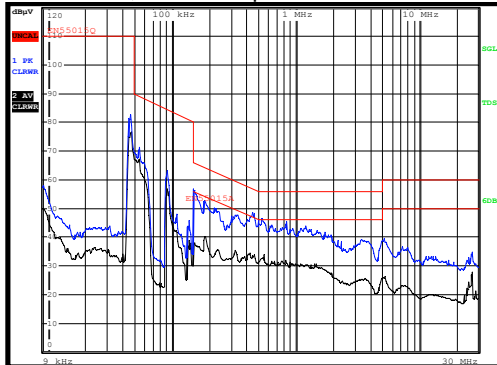

Conduct EMI-N Line

$V_{IN}=120Vac$, 7 LED Output

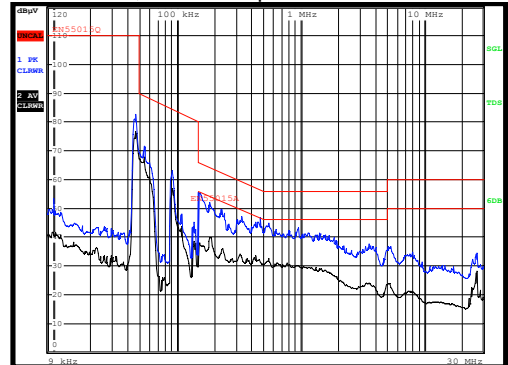

Conduct EMI-L Line

$V_{IN}=230Vac$, 7 LED Output

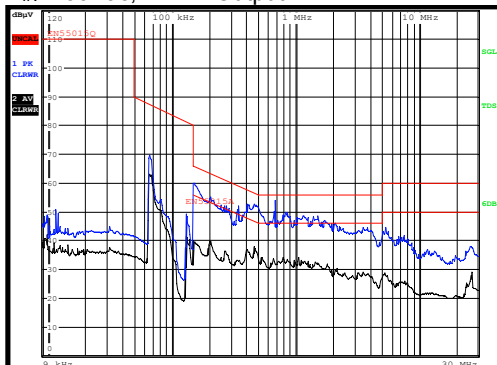

Conduct EMI-N Line

$V_{IN}=120Vac$, 7 LED Output

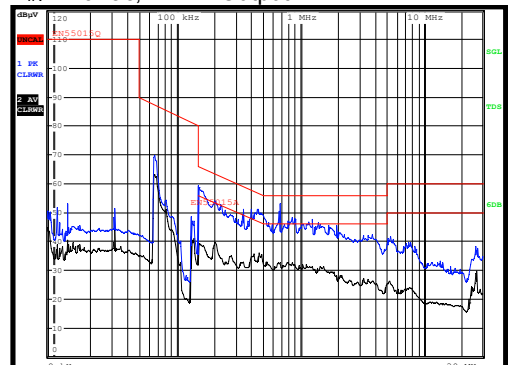

EVB TEST RESULTS(continued)

Performance waveforms are tested on the evaluation board.

$V_{IN}=(90-265)VAC/50Hz$, 7LEDs in series, $I_{LED}=350mA$, $V_{LED}=21V$, $L_p=2.15mH$.

Steady State
 $V_{IN}=120Vac$, 7 LED Output

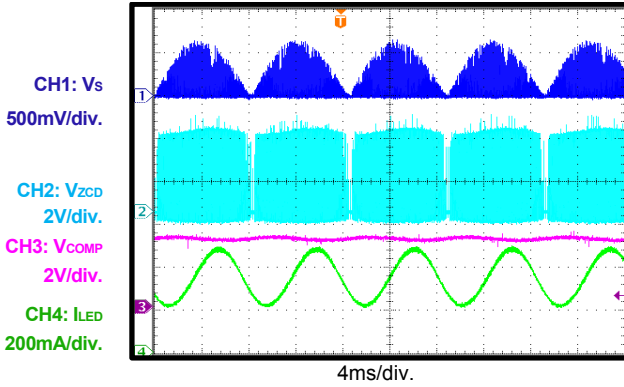

Steady State
 $V_{IN}=120Vac$, 7 LED Output

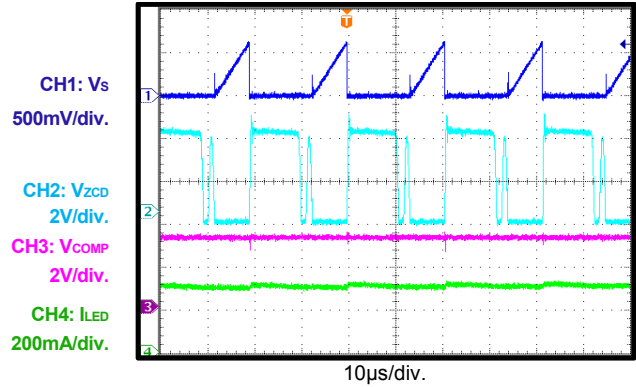

Steady State
 $V_{IN}=230Vac$, 7 LED Output

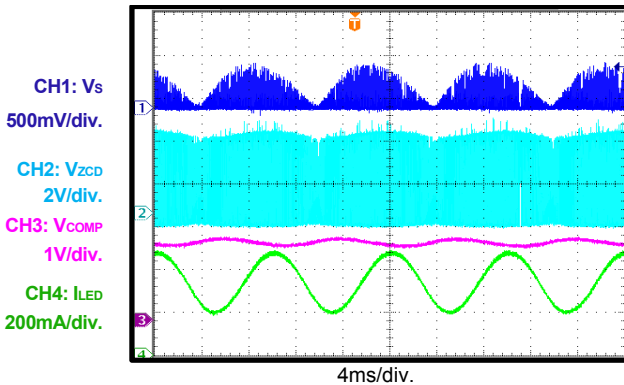

Steady State
 $V_{IN}=230Vac$, 7 LED Output

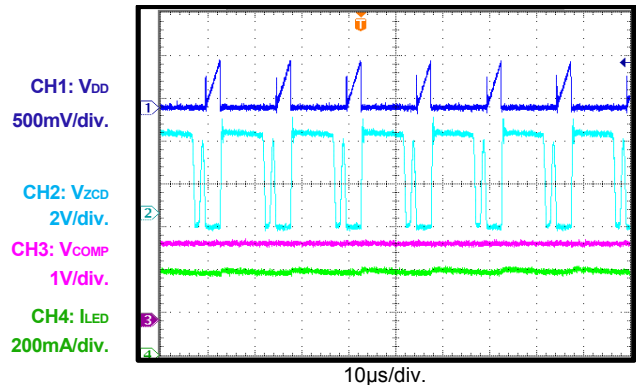

Start-Up
 $V_{IN}=120Vac$, 7 LED Output

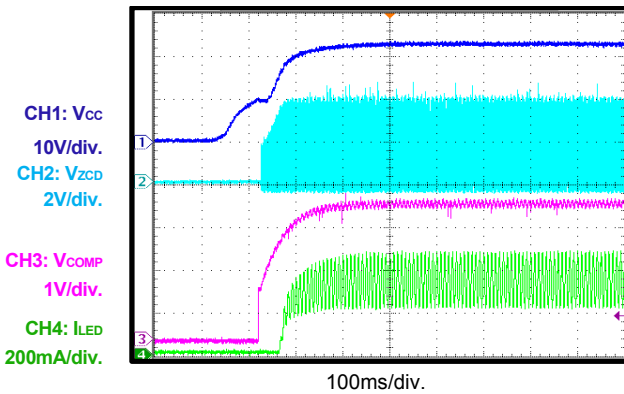

Start-Up
 $V_{IN}=230Vac$, 7 LED Output

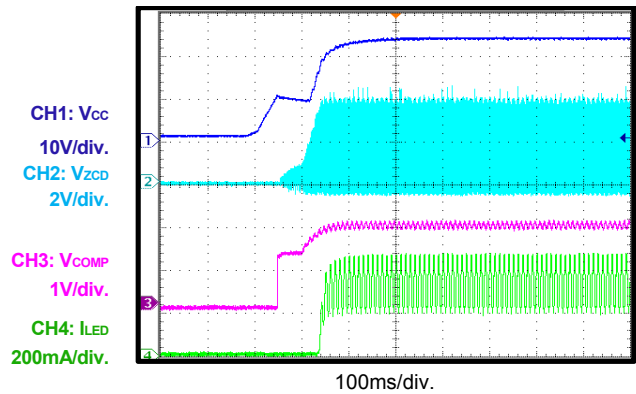

EVB TEST RESULTS(continued)

Performance waveforms are tested on the evaluation board.

 $V_{IN}=(90-265)VAC/50Hz$, 7LEDs in series, $I_{LED}=350mA$, $V_{LED}=21V$, $L_p=2.15mH$.

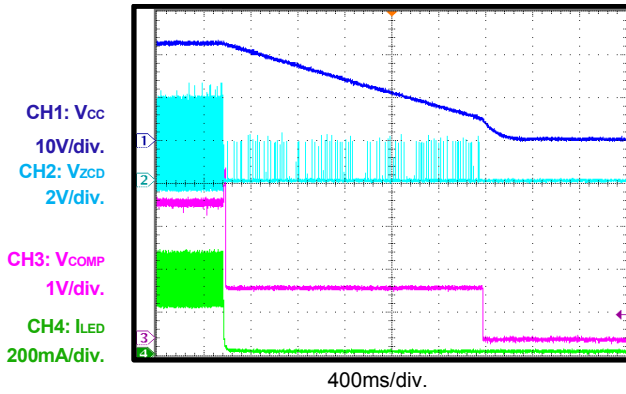
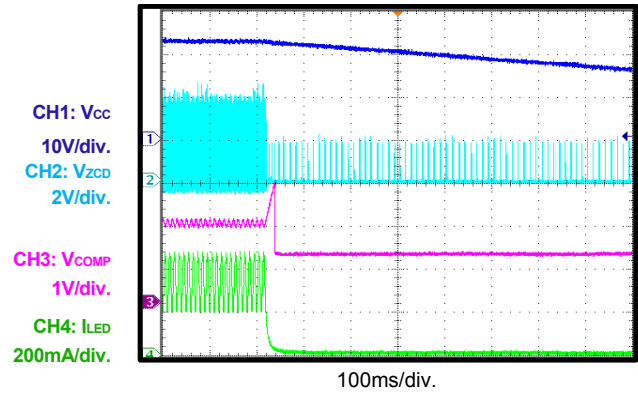
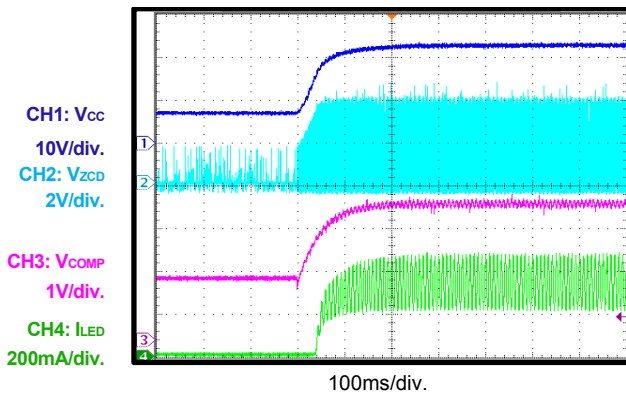
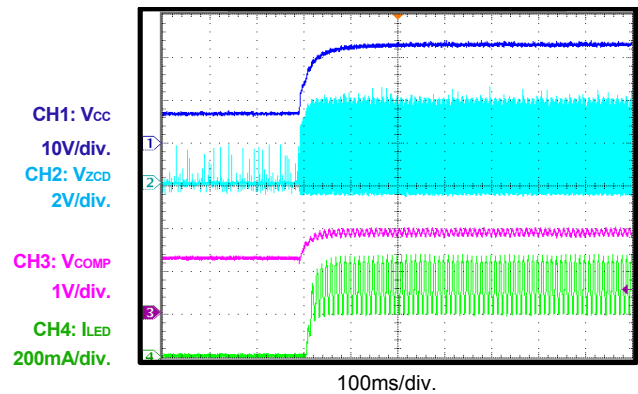
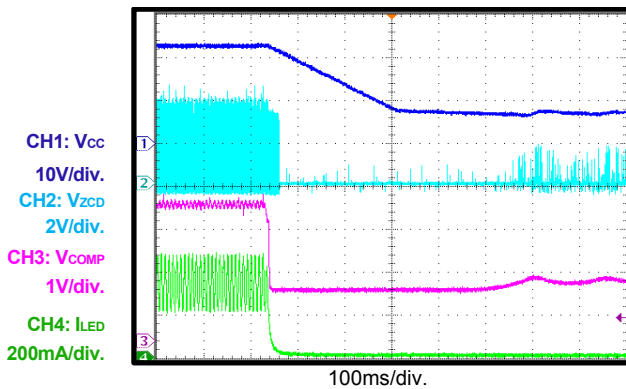
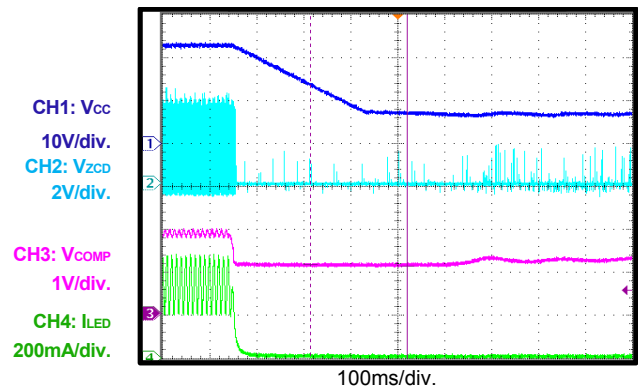
Shutdown
 $V_{IN}=120Vac$, 7 LED Output

Shutdown
 $V_{IN}=230Vac$, 7 LED Output

CV-CC
 $V_{IN}=120Vac$, 7 LED Output

CV-CC
 $V_{IN}=230Vac$, 7 LED Output

CC-CV
 $V_{IN}=120Vac$, 7 LED Output, Full Load

CC-CV
 $V_{IN}=230Vac$, 7 LED Output, Full Load

EVB TEST RESULTS*(continued)*

Performance waveforms are tested on the evaluation board.

$V_{IN}=(90-265)VAC/50Hz$, 7LEDs in series, $I_{LED}=350mA$, $V_{LED}=21V$, $L_p=2.15mH$.

CV-CC

$V_{IN}=120Vac$, 7 LED Output, DIM=1%

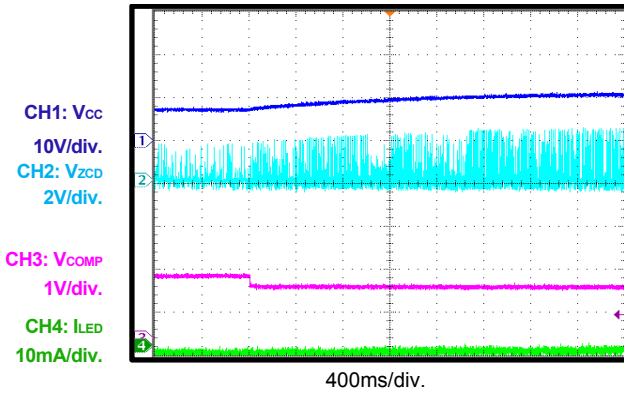

CV-CC

$V_{IN}=230Vac$, 7 LED Output, DIM=1%

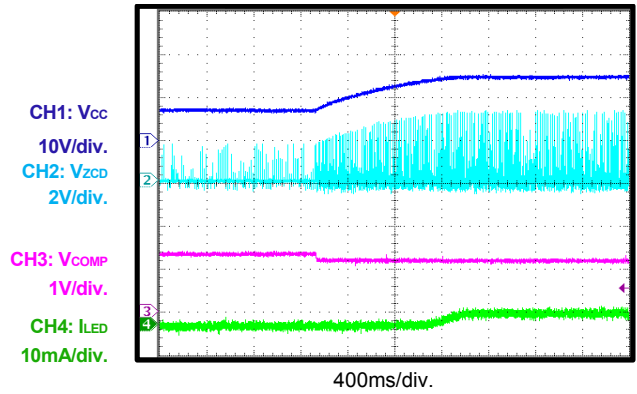

CC-CV

$V_{IN}=120Vac$, 7 LED Output, DIM=1%

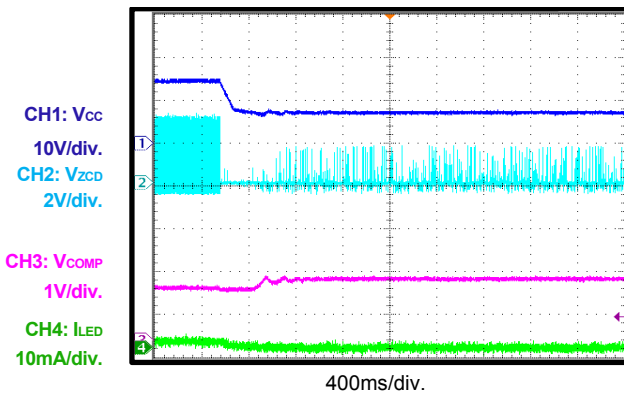

CC-CV

$V_{IN}=230Vac$, 7 LED Output, DIM=1%

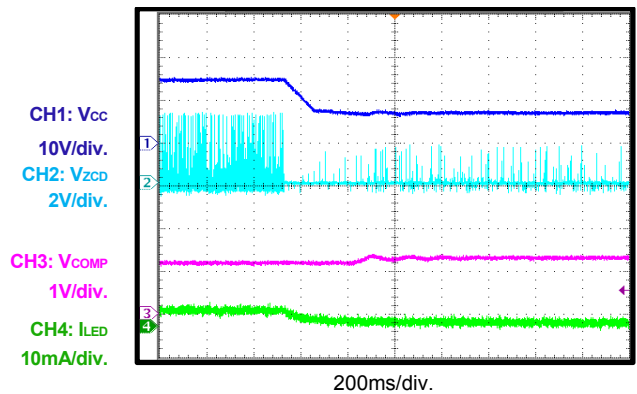

OVP

$V_{IN}=120Vac$, 7 LED Output,
Open LED @ Working and Recover

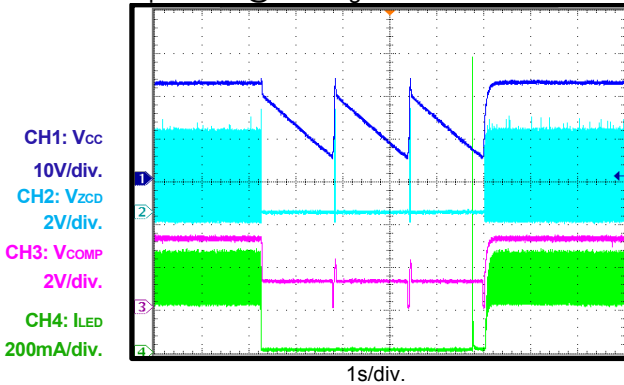

OVP

$V_{IN}=230Vac$, 7 LED Output,
Open LED @ Working and Recover

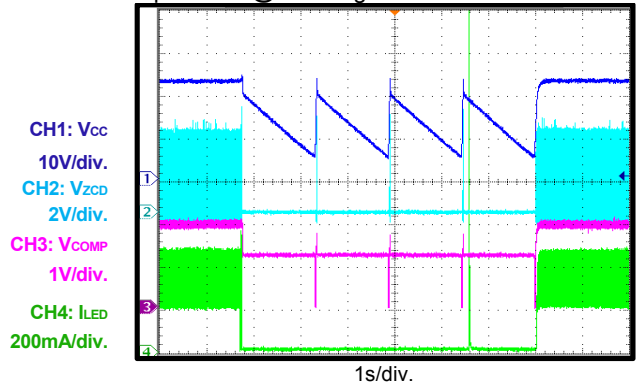

EVB TEST RESULTS*(continued)*

Performance waveforms are tested on the evaluation board.

$V_{IN}=(90-265)VAC/50Hz$, 7LEDs in series, $I_{LED}=350mA$, $V_{LED}=21V$, $L_p=2.15mH$.

SCP

$V_{IN}=120Vac$, 7 LED Output,
Short LED @ Working and Recover

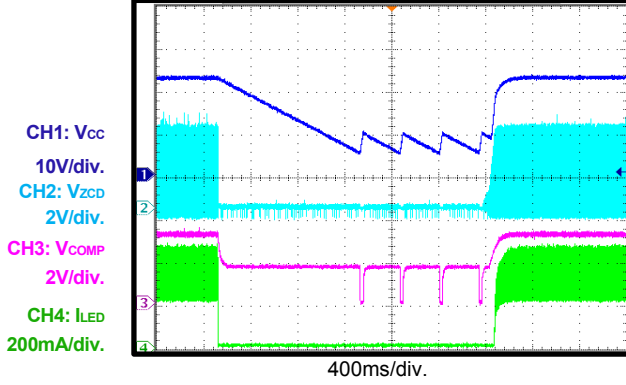

SCP

$V_{IN}=230Vac$, 7 LED Output,
Short LED @ Working and Recover

