

## DESCRIPTION

The EV4425M-QB-00A is an evaluation board for the MP/MPQ4425M.

MP/MPQ4425M is a high-efficiency, synchronous, rectified, step-down, switch-mode white LED driver with built-in power MOSFETs. It offers a very compact solution to achieve a 1.5A continuous output current with excellent load and line regulation over a wide input supply range. The MP/MPQ4425M has synchronous mode operation to get high efficiency.

The EV4425M-QB-00A is a fully assembled and tested evaluation board, which generates load current up to 1.5A from a 4V to 36V input range.

## ELECTRICAL SPECIFICATIONS

Parameter	Symbol	Value	Units
Input Voltage	$V_{IN}$	4 – 36	V
Output Current	$I_{OUT}$	1.5	A

## FEATURES

- EMI Reduction Technique
- Wide 4V-to-36V Operating Input Range
- 85mΩ High-Side, 50mΩ Low-Side Internal Power MOSFETs
- High-Efficiency Synchronous Mode Operation
- Default 2.2MHz Switching Frequency
- PWM Dimming (Min 100Hz Dimming Frequency)
- Force CCM Mode
- 0.2V Reference Mode
- Internal Soft-Start
- Fault Indication for LED Short, Open and Thermal Shutdown
- Over-Current Protection (OCP) with Valley-Current Detection
- Proprietary Switching-Loss-Reduction Technology
- Thermal Shutdown
- Available in a QFN-13 (2.5mmx3mm) Package
- CISPR25 Class5 Compliant
- AEC-Q100 Grade-1

## APPLICATIONS

- Automotive LED Lighting

All MPS parts are lead-free and adhere to the RoHS directive. For MPS green status, please visit MPS website under Quality Assurance. "MPS" and "The Future of Analog IC Technology" are Registered Trademarks of Monolithic Power Systems, Inc.

## EVALUATION BOARD



(L x W x H) 2.5" x 2.5" x 0.4"  
(6.4cm x 6.4cm x 1.0cm)

Board Number	MPS IC Number
EV4425M-QB-00A	MP/MPQ4425MGQB

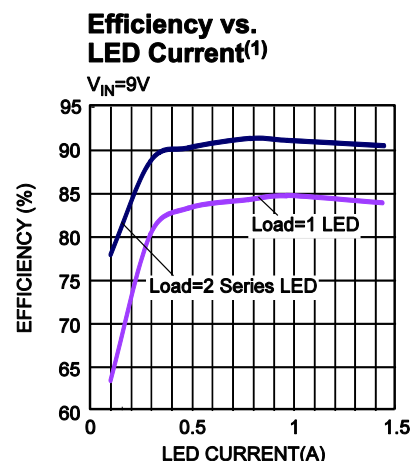

### EVALUATION BOARD SCHEMATIC

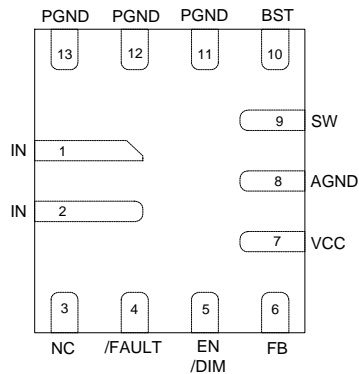
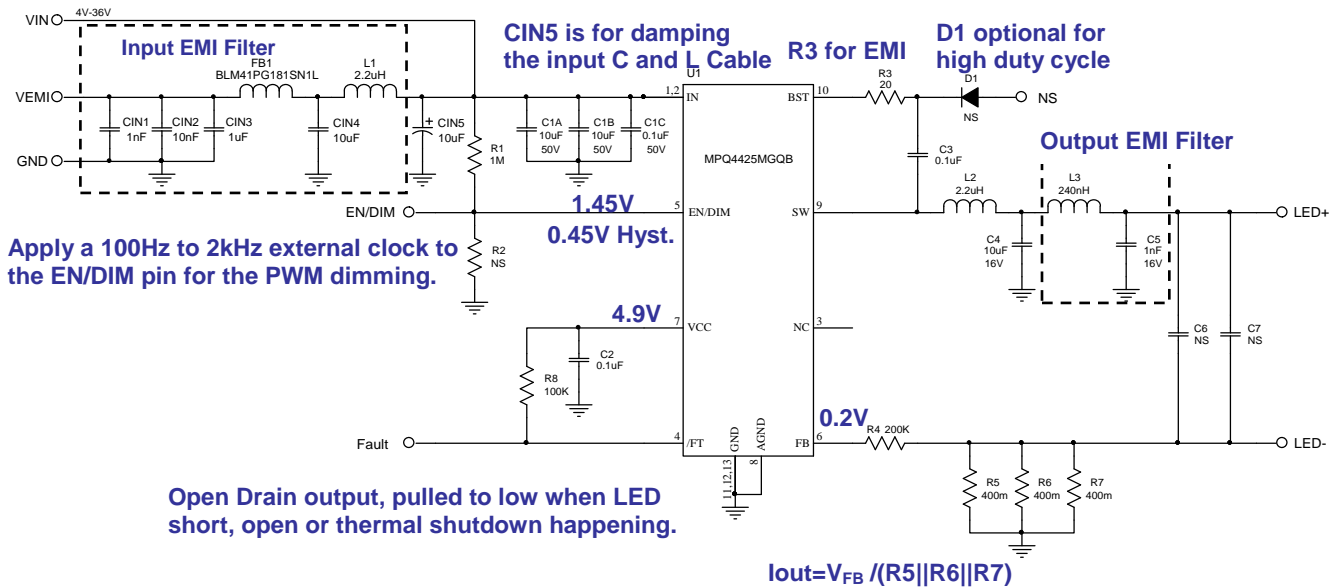

**EV4425M-QB-00A BILL OF MATERIALS**

Qty	Ref	Value	Description	Package	Manufacturer	Part Number
1	CIN1	1nF	Ceramic Cap., 50V, X7R	0603	muRata	GRM188R71H102KA01D
1	CIN2	10nF	Ceramic Cap., 50V, X7R	0603	muRata	GRM188R71H103KA01D
1	CIN3	1 $\mu$ F	Ceramic Cap., 50V, X7R	1206	muRata	GRM31MR71H105KA88L
2	CIN4, CIN5	10 $\mu$ F	Ceramic Cap., 50V, X7R	1210	muRata	GRM32ER71H106KA12L
2	C1A, C1B	10 $\mu$ F	Ceramic Cap., 50V, X5R	1206	muRata	GRM31CR61H106KA12L
1	C1C	0.1 $\mu$ F	Ceramic Cap., 50V, X7R	0603	muRata	GRM188R71H104KA93D
2	C2, C3	0.1 $\mu$ F	Ceramic Cap., 16V, X7R	0603	muRata	GRM188R71C104KA01D
1	C4	10 $\mu$ F	Ceramic Cap., 16V, X7R	1210	muRata	GRM32DR71C106KA01L
1	C5	1nF	Ceramic Cap., 16V, X7R	0603	muRata	GRM188R71C102KA01D
2	C6, C7	NS				
1	D1	NS				
1	FB1		Bead, 180ohm at 100MHz, 3.5A	1812	muRata	BLM41PG181SN1L
2	L1, L2	2.2 $\mu$ H	Inductor, 82mOhm DCR, 3.3A	SMD	TOKO	DFE252012F-2R2MP2
1	L3	240nH	Inductor, 19mOhm DCR, 5A	SMD	TOKO	DFE201612E-R24MP2
1	R1	1M	Film Res., 5%	0603	Yageo	RC0603JR-071ML
1	R3	20	Film Res., 1%	0603	Yageo	RC0603FR-0720RL
1	R4	200k	Film Res., 1%	0603	Yageo	RC0603FR-07200KL
3	R5, R6, R7	400m	Film Res., 1%	1206	Yageo	RL1206FR-070R4L
1	R8	100k	Film Res., 1%	0603	Yageo	RC0603FR-07100KL
1	R2	NS				
1	U1		Step-Down Regulator	QFN13(2X3)	MPS	MPQ4425MGQB
5	VIN, VEMI, GND, GND, VOUT		2.0 Golden Pin		HZ	
4	PG, GND, EN/DIM, GND		2.54mm Test Pin		HZ	

## TYPICAL CHARACTERISTICS

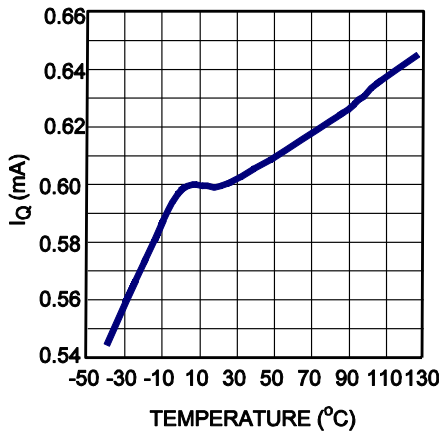
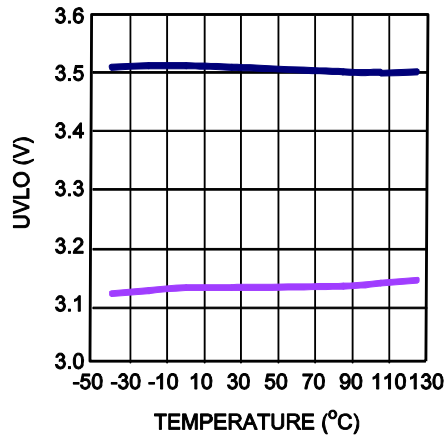
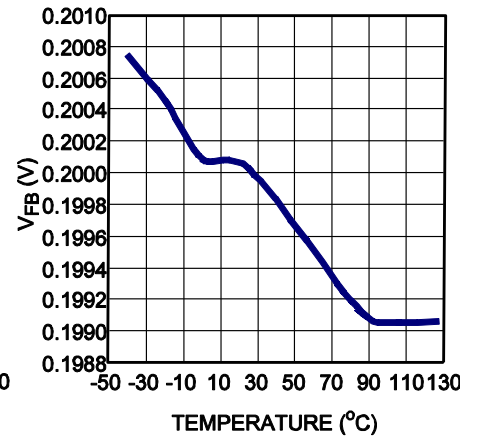
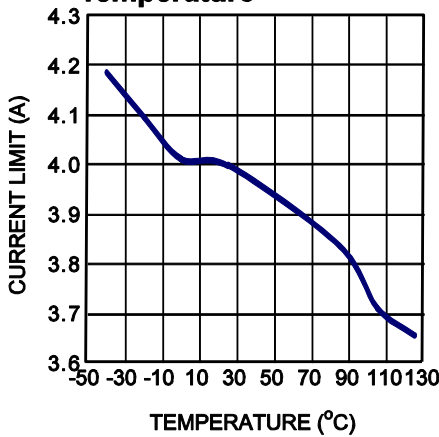
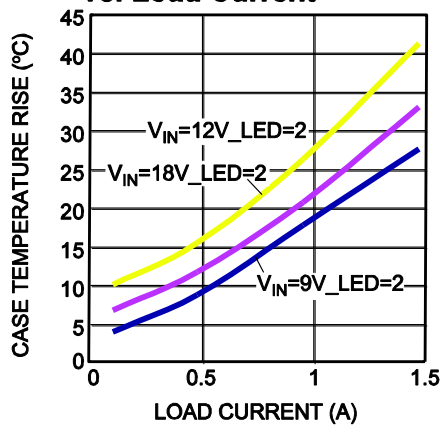
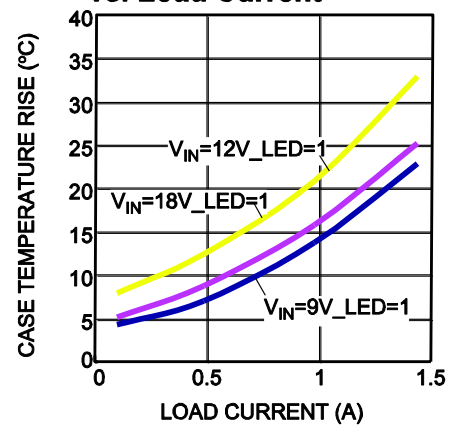
 **$I_Q$  vs. Temperature**

 **$V_{IN}$  UVLO vs. Temperature**

 **$V_{FB}$  vs. Temperature**

**Current Limit vs. Temperature**

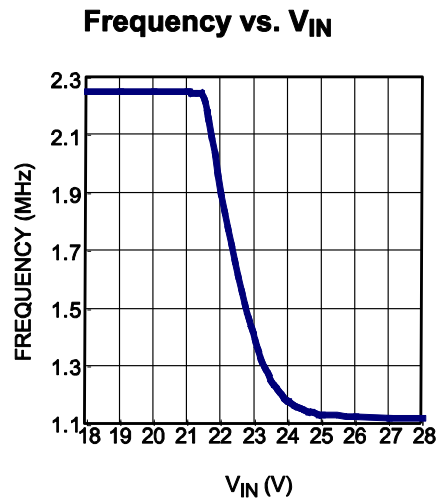
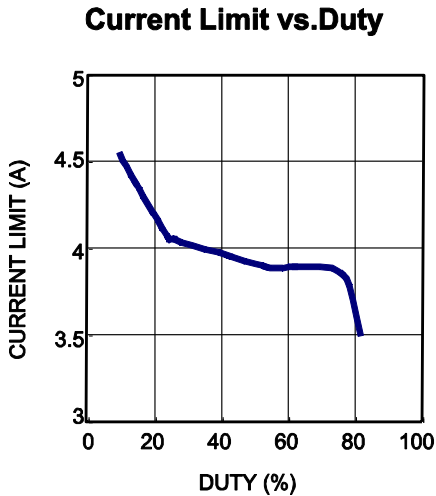
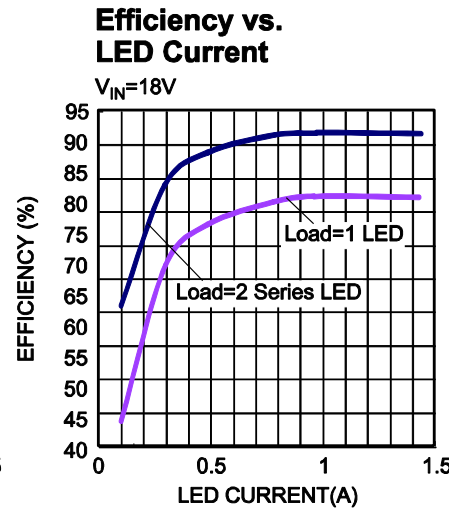
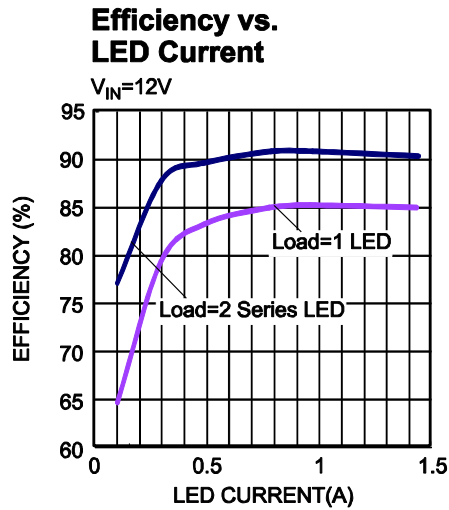
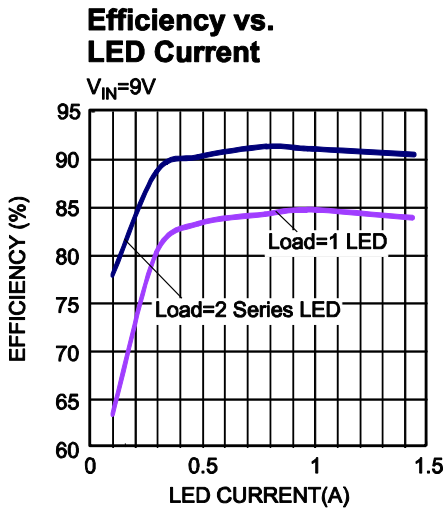
**Case Temperature Rise vs. Load Current**

**Case Temperature Rise vs. Load Current**

## EVB TEST RESULTS

Performance waveforms are tested on the evaluation board.

$V_{IN} = 12V$ , LOAD=2 series LED,  $L=2.2\mu H$ ,  $F_{SW}=2.2MHz$ ,  $T_A = +25^\circ C$ , unless otherwise noted.<sup>(1)</sup>



**Note:**

1). All the efficiency curves are tested on EVB without input and output filters.

## EVB TEST RESULTS *(continued)*

Performance waveforms are tested on the evaluation board.

$V_{IN} = 12V$ , LOAD=2 series LED,  $I_{LED}=1.5A$ ,  $L=2.2\mu H$ ,  $F_{SW}=2.2MHz$ , with EMI filters,  $T_A = +25^\circ C$ , unless otherwise noted. <sup>(2)</sup>

**CISPR25 Class 5 Peak Radiated Emissions (150kHz-30MHz)**

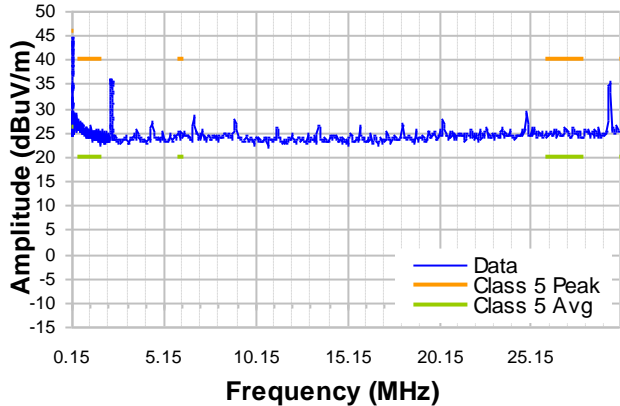

**CISPR25 Class 5 Average Radiated Emissions (150kHz-30MHz)**

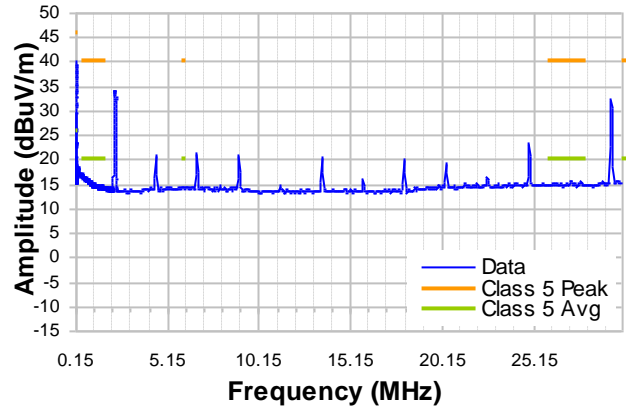

**CISPR25 Class 5 Peak Radiated Emissions (Vertical, 30MHz-1GHz)**

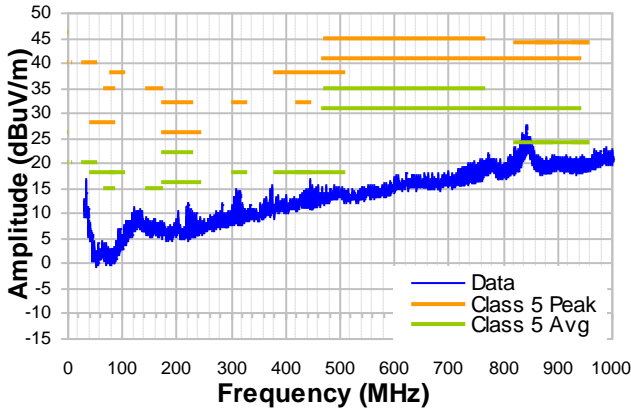

**CISPR25 Class 5 Average Radiated Emissions (Vertical, 30MHz-1GHz)**

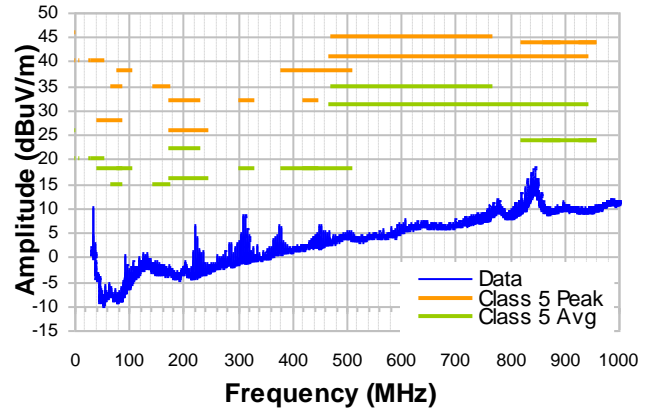

**CISPR25 Class 5 Peak Radiated Emissions (Horizontal, 30MHz-1GHz)**

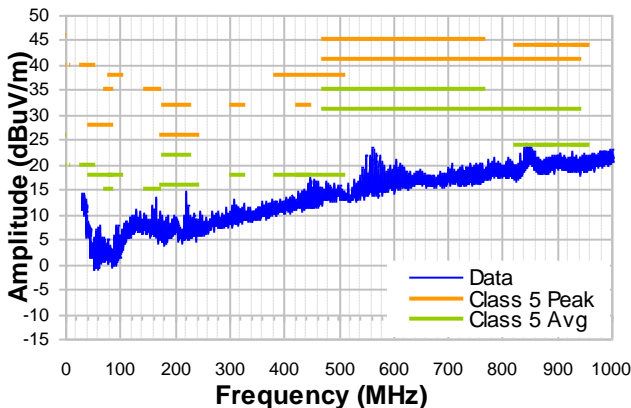

**CISPR25 Class 5 Average Radiated Emissions (Horizontal, 30MHz-1GHz)**

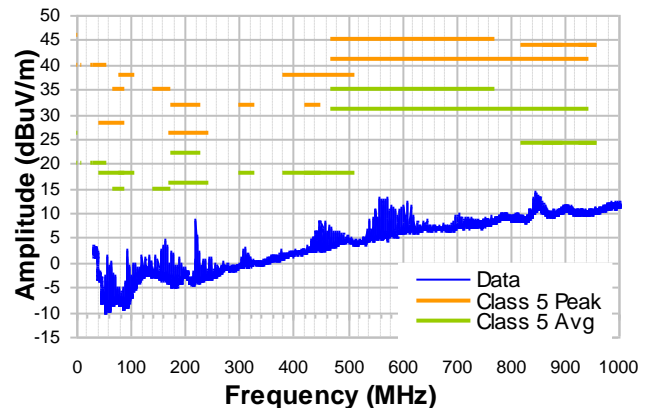

### EVB TEST RESULTS *(continued)*

Performance waveforms are tested on the evaluation board.

$V_{IN} = 12V$ , LOAD=2 series LED,  $I_{LED}=1.5A$ ,  $L=2.2\mu H$ ,  $F_{SW}=2.2MHz$ , with EMI filters,  $T_A = +25^\circ C$ , unless otherwise noted. <sup>(2)</sup>

**CISPR25 Class5 Peak Conducted Emissions (150kHz-108MHz)**

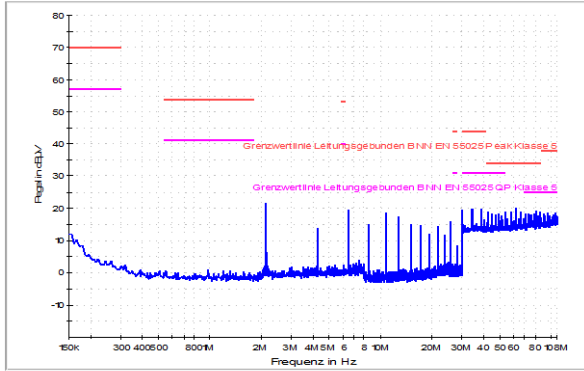

**CISPR25 Class5 Average Conducted Emissions (150kHz-108MHz)**

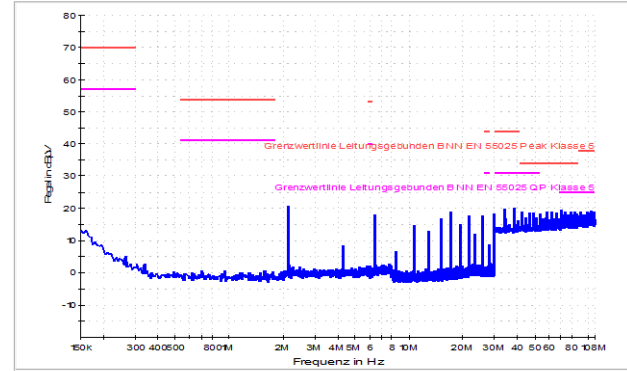

**Note:**

2). The EMI test results are based on application circuit with input and output EMI filters.

## EVB TEST RESULTS *(continued)*

Performance waveforms are tested on the evaluation board.

$V_{IN} = 12V$ , LOAD=2 series LED,  $L=2.2\mu H$ ,  $F_{SW}=2.2MHz$ ,  $T_A = +25^\circ C$ , unless otherwise noted.

### Steady State

$I_{LED} = 0A$

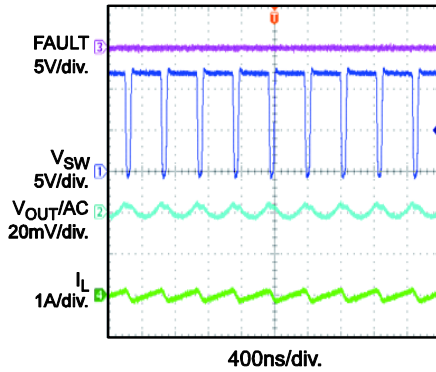

### Steady State

$I_{LED} = 1.5A$

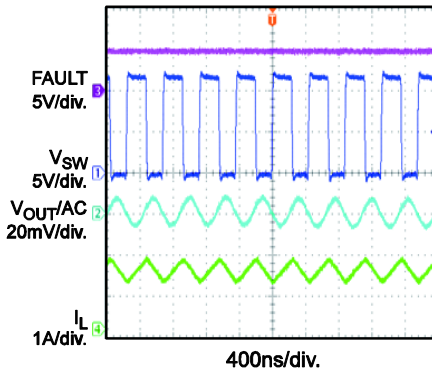

### Start-Up through $V_{IN}$

$I_{LED} = 0A$

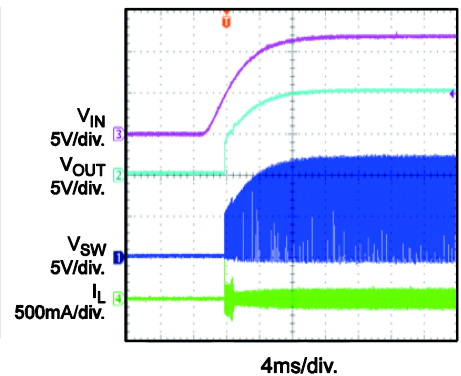

### Start-Up through $V_{IN}$

$I_{LED} = 1.5A$

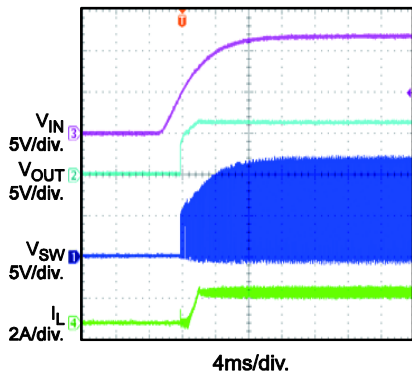

### Shutdown through $V_{IN}$

$I_{LED} = 0A$

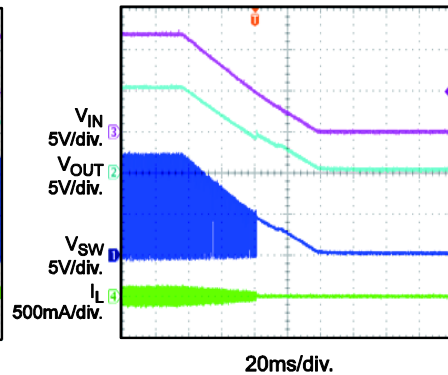

### Shutdown through $V_{IN}$

$I_{LED} = 1.5A$

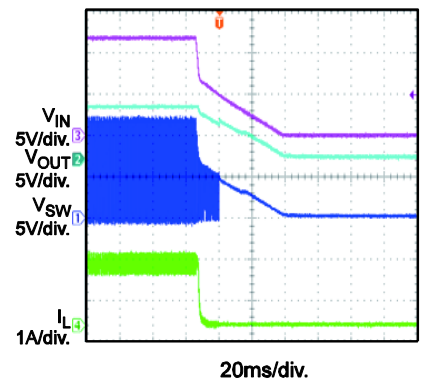

### Start-Up through EN

$I_{LED} = 0A$

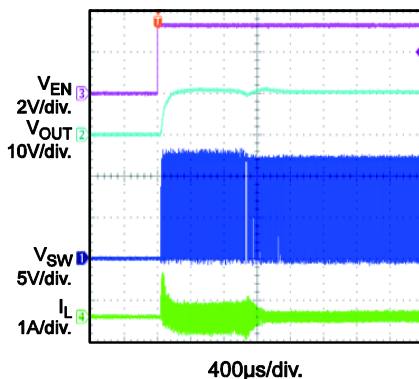

### Start-Up through EN

$I_{LED} = 1.5A$

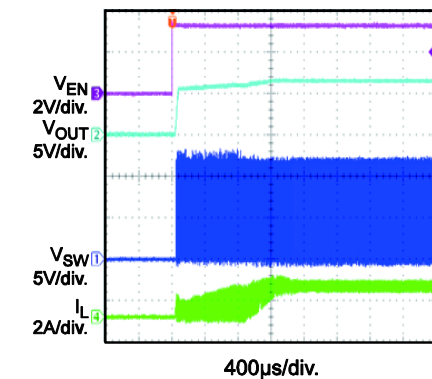

### Shutdown through EN

$I_{LED} = 1.5A$

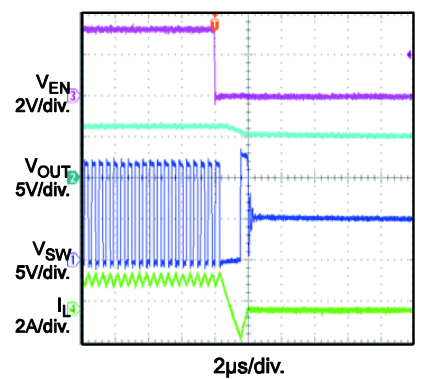



## EVB TEST RESULTS *(continued)*

Performance waveforms are tested on the evaluation board.

$V_{IN} = 12V$ ,  $LOAD=2$  series LED,  $L=2.2\mu H$ ,  $F_{SW}=2.2MHz$ ,  $T_A = +25^\circ C$ , unless otherwise noted.

**PWM Dimming**  
400Hz

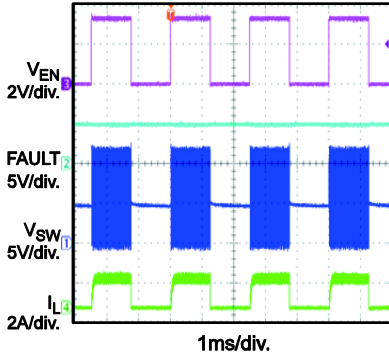

**PWM Dimming**  
2kHz

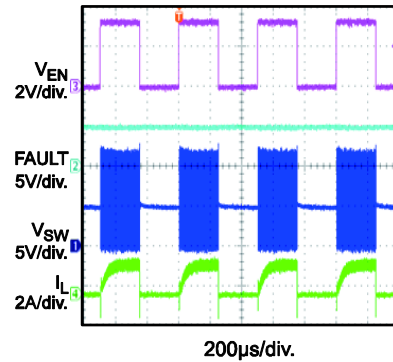

**LED+ Short to GND**  
Steady State

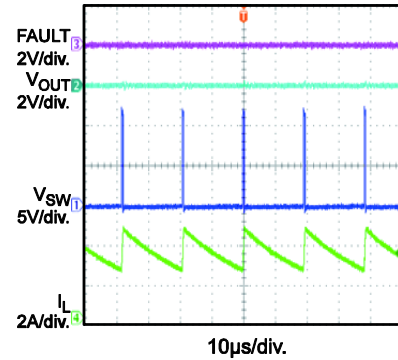

**LED+ Short to GND Entry**  
 $I_{LED} = 0A$

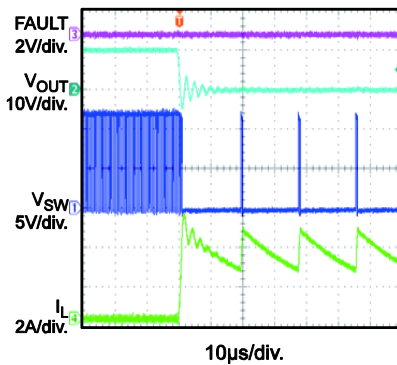

**LED+ Short to GND Entry**  
 $I_{LED} = 1.5A$

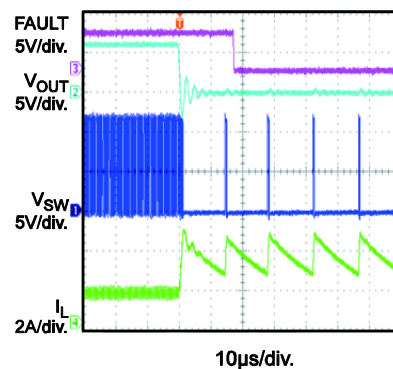

**LED+ Short to GND Recovery**  
 $I_{LED} = 0A$

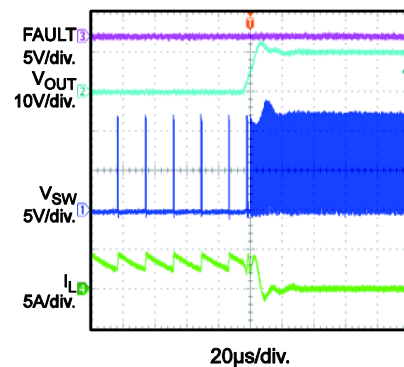

**LED+ Short to GND Recovery**  
 $I_{LED} = 1.5A$

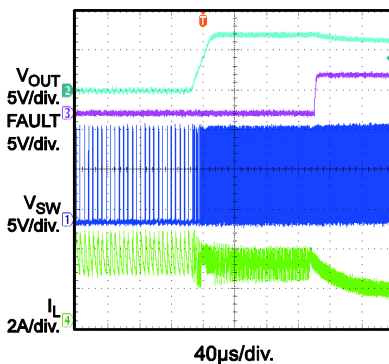

**LED+ Short to GND**  
Input Power On

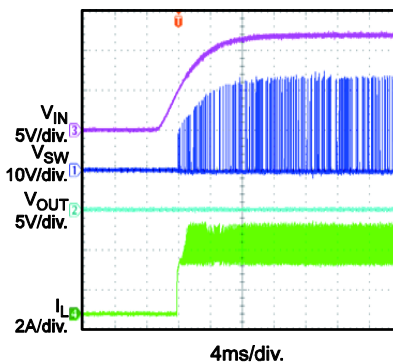

**LED+ Short to GND**  
Input Power Off

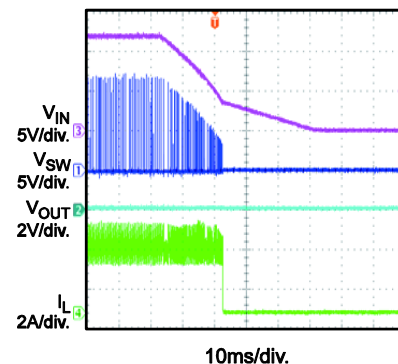

**EVB TEST RESULTS** *(continued)*

Performance waveforms are tested on the evaluation board.

 $V_{IN} = 12V$ , LOAD=2 series LED,  $L=2.2\mu H$ ,  $F_{SW}=2.2MHz$ ,  $T_A = +25^\circ C$ , unless otherwise noted.

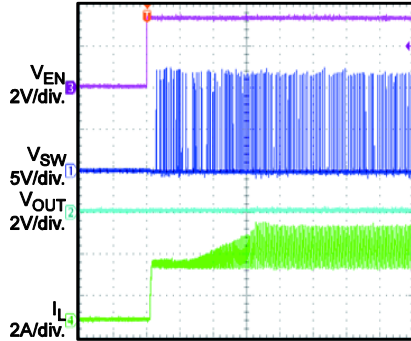
**LED+ Short to GND EN On**

400µs/div.

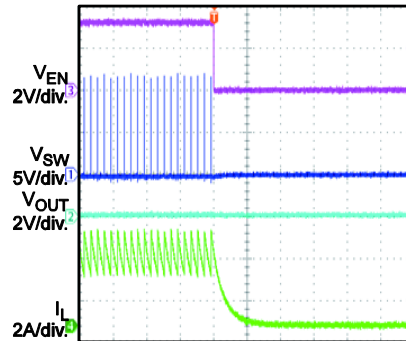
**LED+ Short to GND EN Off**

100µs/div.

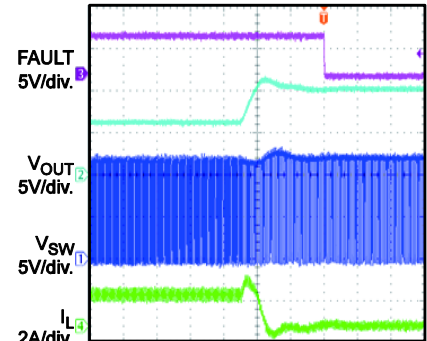
**LED Open Entry**

10µs/div.

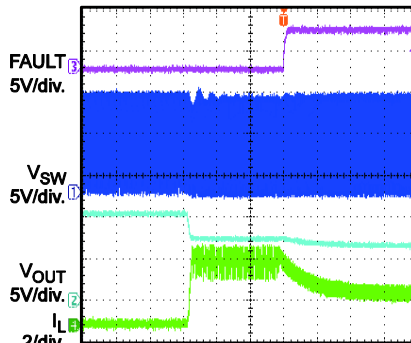
**LED Open Recovery**

40µs/div.

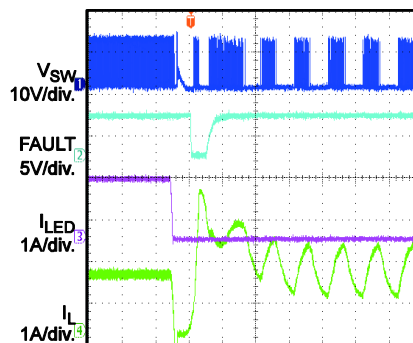
**LED+ and LED- Short Entry**

20µs/div.

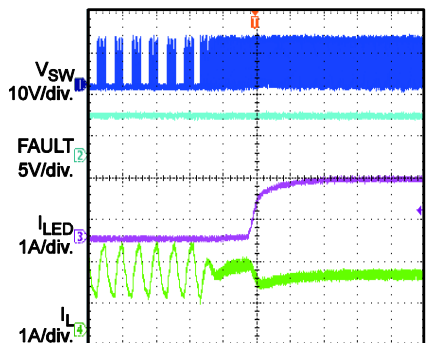
**LED+ and LED- Short Recovery**

40µs/div.

## PRINTED CIRCUIT BOARD LAYOUT

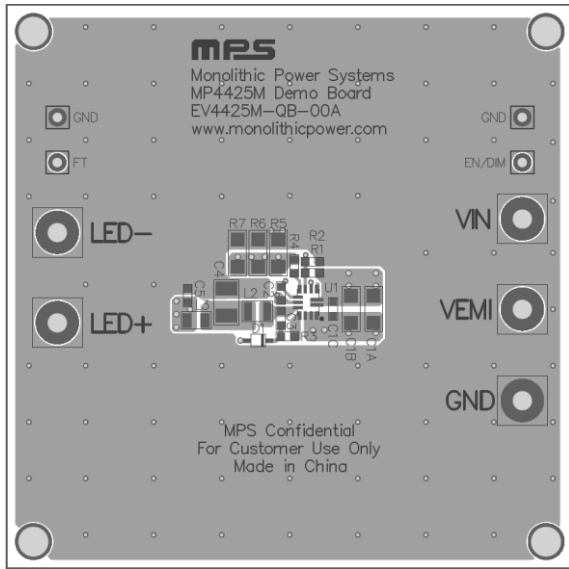

Figure 1—Top Silk Layer and Top Layer

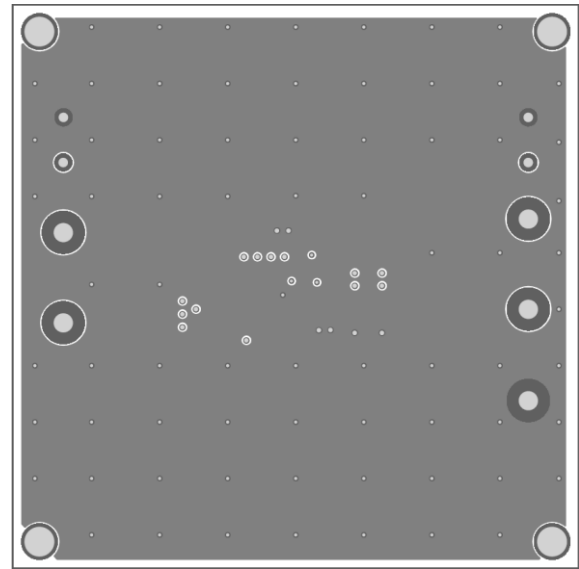

Figure 2—Inner1 Layer

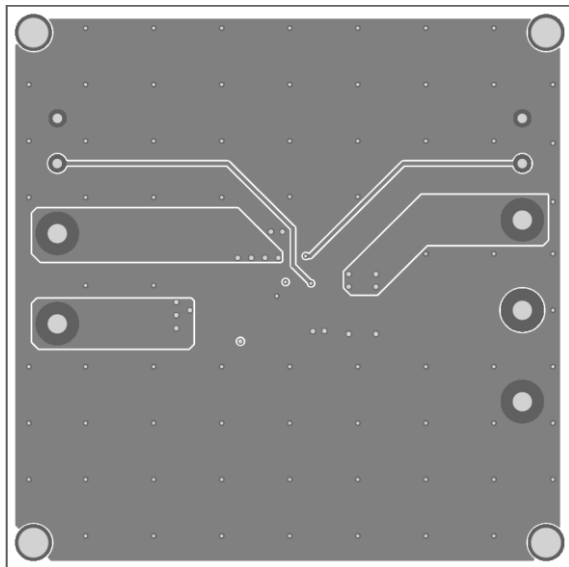

Figure 3—Inner2 Layer

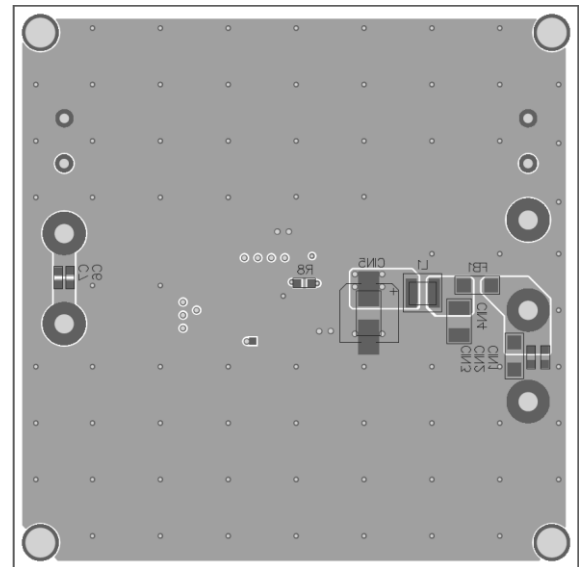

Figure 4—Bottom Silk Layer and Bottom Layer