

## DESCRIPTION

The MP5016H is a protection device designed to protect circuitry on the output from transients on input. It also protects input from undesired shorts and transients coming from the output.

At startup, inrush current is limited by limiting the slew rate at the output. The slew rate is controlled by DV/DT pin setting and MODE pin setting.

The maximum load at the output is current limited. The magnitude of the current limit is controlled by an external resistor from ILIMIT to GND. There is a fixed 2.5A current limit when floating ILIMIT pin.

The output voltage is limited by output OVP function, the clamp voltage can be set by MODE pin connection.

Offers a GATE drive signal to block current flows from output to input with an external N-channel MOSFETs.

The MP5016H is available in a QFN10 (1.5mm x 2mm) package.

## ELECTRICAL SPECIFICATION

Parameter	Value	Units
Input Voltage	2.7 to 22	V
Current Limit	2.5	A
DV/DT Slew Rate	3.8	V/ms

## FEATURES

- Wide 2.7V to 22V Continued Operating Input Range
- 26V Absolute Maximum Transient Input Voltage
- Selectable Over Voltage Clamp Threshold
- Fast Output OVP Response
- Integrated 43mΩ Power FET
- Adjustable Current-Limit or Fixed Current Limit when floating ILIMIT pin
- Reverse Current Blocking CTRL
- Soft Start Time Programmable through DV/DT pin and MODE pin
- Fast Response for Hard Short Protection
- OCP Hiccup Protection
- Thermal Shutdown and Auto Retry
- Available in QFN10 (1.5mmx2mm) Package

## APPLICATIONS

- HDD, SSD
- Hot Swap
- Wireless Modem Data Cards
- PC Cards
- USB Power Distribution
- USB Protection
- USB3.1 Power Delivery

All MPS parts are lead-free, halogen free, and adhere to the RoHS directive. For MPS green status, please visit MPS website under Quality Assurance. "MPS" and "The Future of Analog IC Technology" are Registered Trademarks of Monolithic Power Systems, Inc.

## EV5016H-QH-00B EVALUATION BOARD



(L×W)5.0cm×5.0cm

Board Number	MPS IC Number
EV5016H-QH-00B	MP5016HGQH

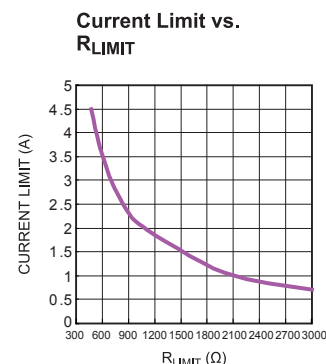

## EVALUATION BOARD SCHEMATIC

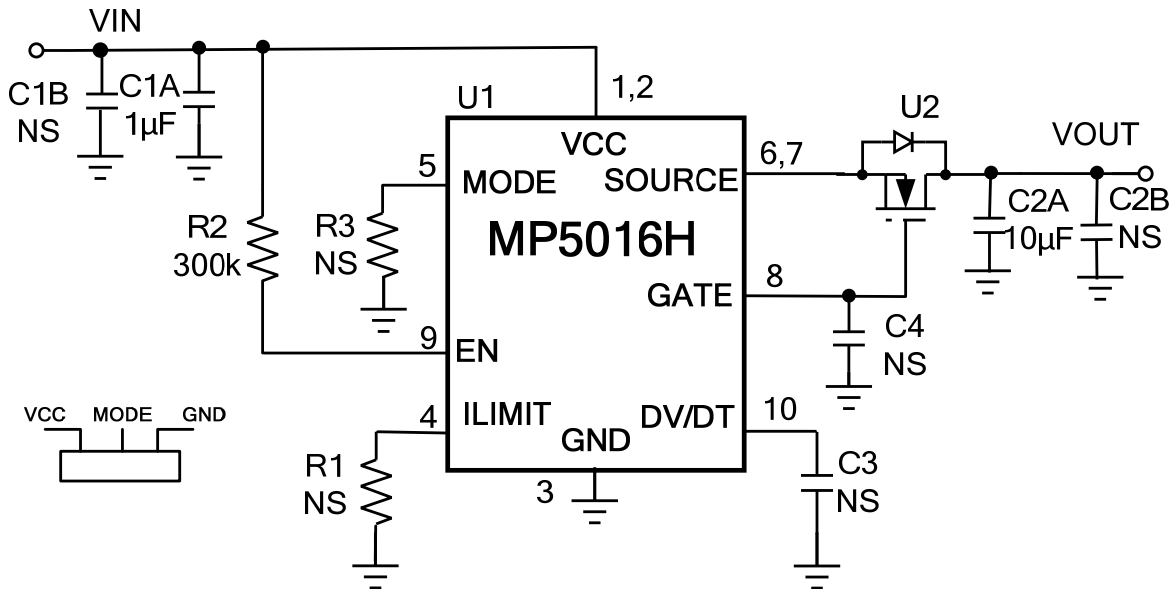

## EV5016H-QH-00B BILL OF MATERIALS

Qty	Ref	Value	Description	Package	Manufacturer	Manufacturer P/N
1	C1A	1µF	Ceramic Cap,25V,X5R	0805	Murata	GRM216R61E105KA12D
0	C1B, C2B, C3,C4	NS				
1	C2A	10µF	Ceramic Cap,25V,X5R	0805	Murata	GRM21BR61E106KA73L
0	R1, R3	NS				
1	R2	300k	1% resistor	0603	ROYAL	RL0603FR-07300KL
1	U1	MP5016H	Electronic Fuse	QFN 1.5x2-10	MPS	MP5016HGQH
1	U2	IRFHS8342	NMOS, Vds=30V, Vgs=20V. Rds(on)=16mΩ,	QFN 2x2	Infineon	IRFHS8342

## EVB TEST RESULTS

$V_{IN}=5V$ ,  $V_{OUT}=5V$ ,  $I_{LIMIT}$  pin float,  $MODE$  pin float,  $DV/DT$  pin float,  $C_{OUT}=10\mu F$ ,  $T_A=25^\circ C$ , unless otherwise noted.

**Start-Up through Input Voltage**

$I_{LOAD}=0A$

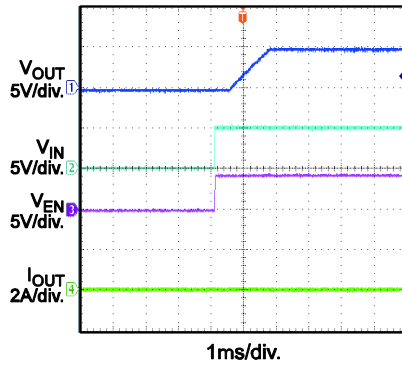

**Start-Up through Input Voltage**

$I_{LOAD}=2A$

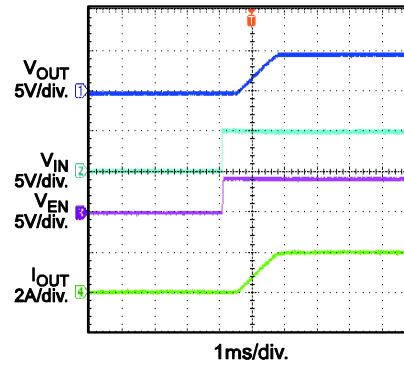

**Start-Up through Input Voltage**

$I_{LOAD}=0A$ ,  $C_{OUT}=1000\mu F$

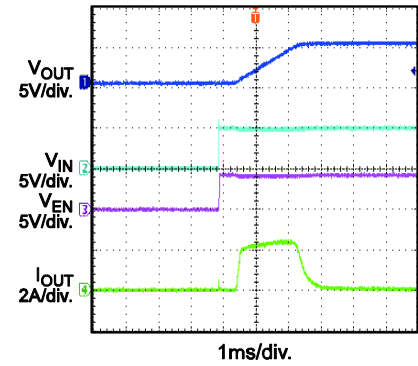

**Start-Up through Enable**

$I_{LOAD}=0A$

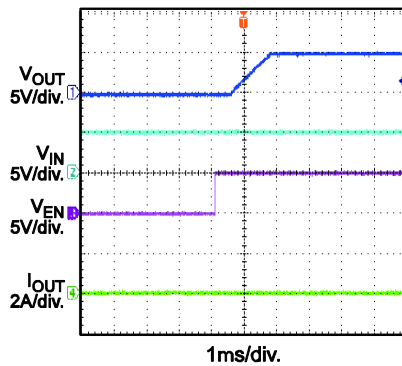

**Start-Up through Enable**

$I_{LOAD}=2A$

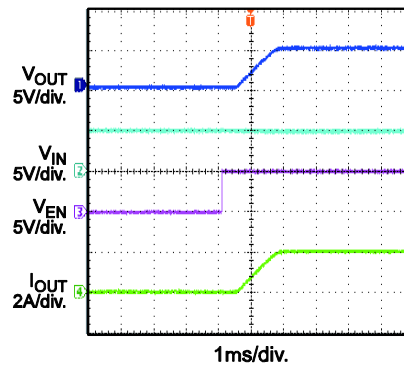

**Start-Up through Enable**

$I_{LOAD}=0A$ ,  $C_{OUT}=1000\mu F$

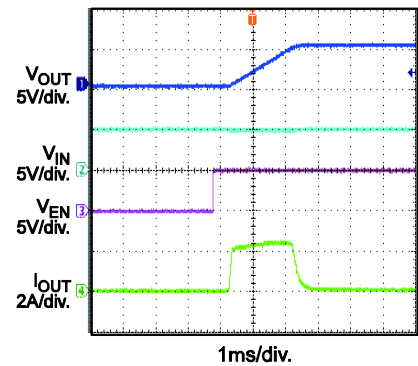

**Shutdown through Input Voltage**

$I_{LOAD}=0A$

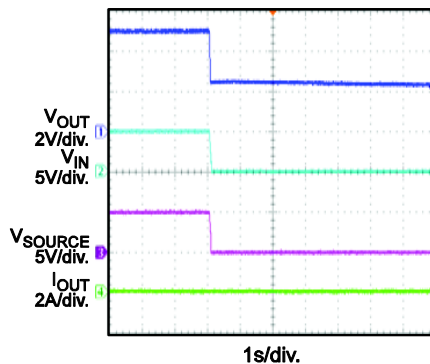

**Shutdown through Input Voltage**

$I_{LOAD}=2A$

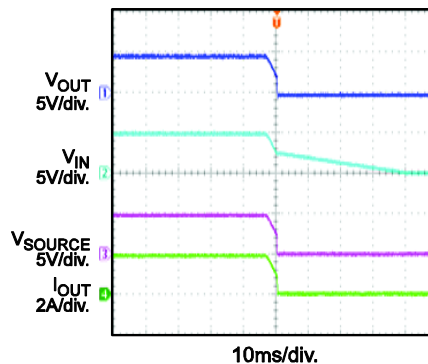

**Shutdown through Enable**

$I_{LOAD}=0A$

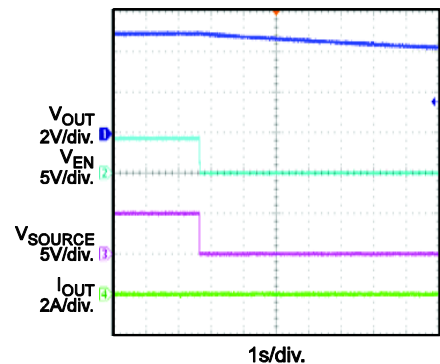

## EVB TEST RESULTS

$V_{IN}=5V$ ,  $V_{OUT}=5V$ ,  $I_{LIMIT}$  pin float,  $MODE$  pin float,  $DV/DT$  pin float,  $C_{OUT}=10\mu F$ ,  $T_A=25^\circ C$ , unless otherwise noted.

**Shutdown through Enable**  
 $I_{LOAD}=2A$

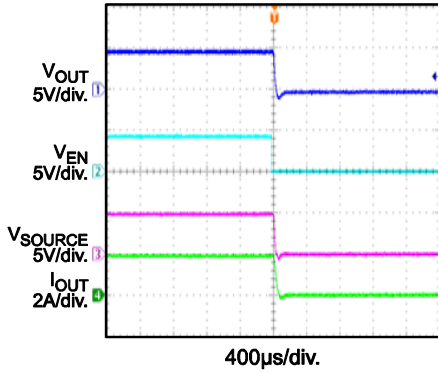

**Current Limit**  
 Increase  $I_{OUT}$  Slowly

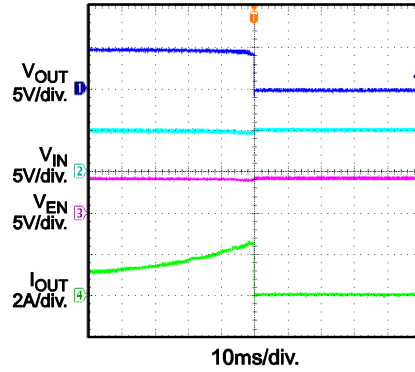

**Short Circuit during Normal Operation and Hiccup**  
 $I_{LOAD}=0A$

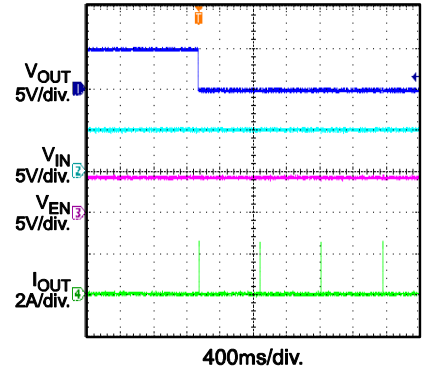

**Reverse Current Protection during EN Shutdown**

$V_{OUT} = 5V$ , Pull EN Low

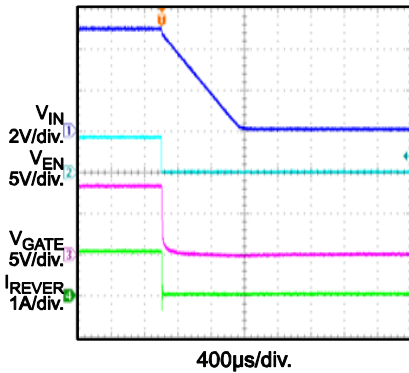

## CIRCUIT BOARD LAYOUT

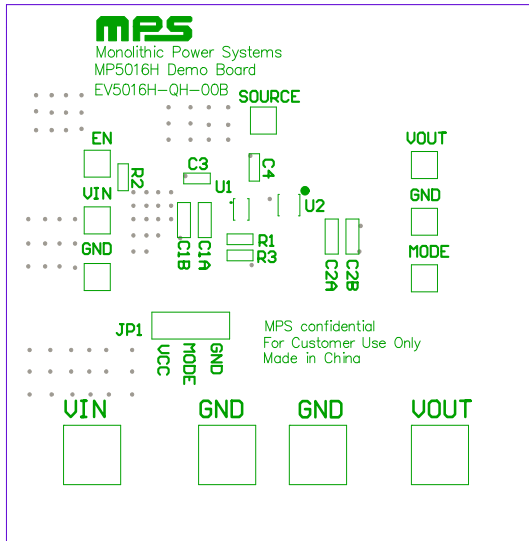

Figure 1: Top Silkscreen Layer

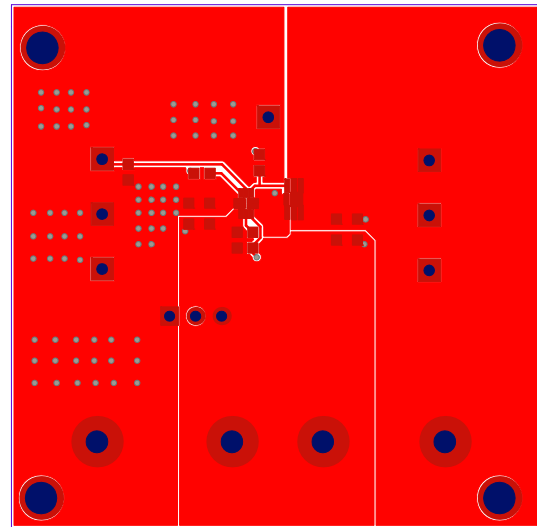

Figure 2: Top Layer

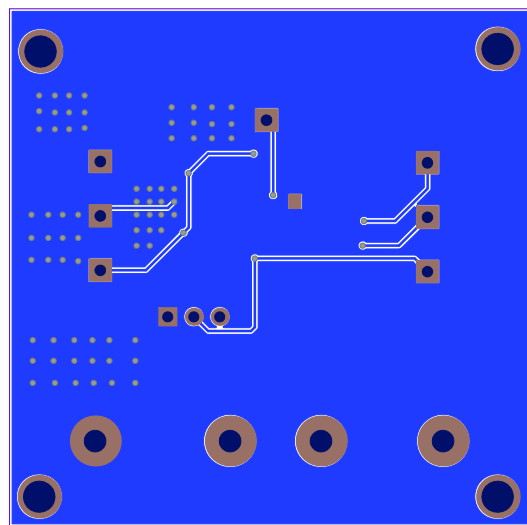

Figure 3: Bottom Layer