



The Future of Analog IC Technology®

# EV5094-J-00A

## Dual Channel Current Limit Switch with Over Voltage Clamp

### DESCRIPTION

The EV5094-J-00A Evaluation Board is designed to demonstrate the capabilities of MPS' MP5094, a protection device designed to protect circuitry on the output from transients on input. It also protects input from undesired shorts and transients coming from the output. MP5094 is a small  $R_{ON}$ , low quiescent current, dual channel current limited switch.

At startup, the inrush current is limited by limiting the slew rate at the output. The slew rate is controlled by a capacitor at the SS pin.

The maximum load at the output is current limited. The magnitude of the current limit is internal fixed.

The output voltage is limited by the output over voltage protection (OVP) function.

The MP5094 is available in a space-saving 8 pin-TSOT23 package.

### ELECTRICAL SPECIFICATION

Parameter	Symbol	Value	Units
Input Voltage1	$V_{IN1}$	12	V
Input Voltage2	$V_{IN12}$	5	V
Output Current1	$I_{OUT1}$	3	A
Output Current2	$I_{OUT2}$	2	A

### FEATURES

- Integrated 5V, 12V Input Dual Efuse
- 24V 100ms Maximum Surge Input Voltage Tolerance for 12V BUS
- 16V 100ms Maximum Surge Input Voltage Tolerance for 5V BUS
- Integrated Dual Channel Current Limit Switch
- 50mΩ/30mΩ Low  $R_{DS(ON)}$  for 12V BUS/ 5V BUS Current Limit Switch
- 110μA Typical Low Quiescent Current for 12V BUS/5V BUS
- Soft Start Time Programmable
- Fixed 4A/2.95A Trip/Hold Current Limit for 12V BUS
- Fixed 3A/2.18A Trip/Hold Current Limit for 5V BUS
- OCP Hiccup
- Thermal Shutdown Latch-Off
- Available in TSOT23-8 Package

### APPLICATIONS

- Hard Disk Drives
- Solid State Drives
- Hot Swap

All MPS parts are lead-free, halogen free, and adhere to the RoHS directive. For MPS green status, please visit MPS website under Quality Assurance.  
 "MPS" and "The Future of Analog IC Technology" are Registered Trademarks of Monolithic Power Systems, Inc.

### EV5094-J-00A EVALUATION BOARD

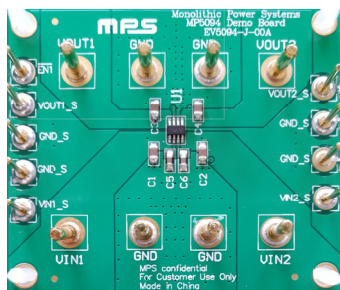

<b>(L x W x H) 54mm x 46mm x 6.4mm</b>	
<b>Board Number</b>	<b>MPS IC Number</b>
EV5094-J-00A	MP5094GJ

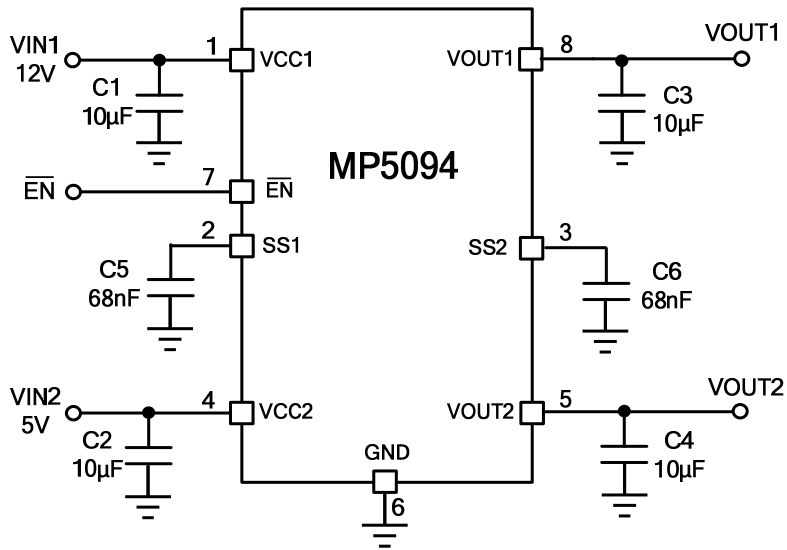
**EVALUATION BOARD SCHEMATIC**

**EV5094-J-00A BILL OF MATERIALS**

Qty	Ref	Value	Description	Package	Manufacturer	Part Number
4	C1, C2, C3, C4	10µF	Ceramic Cap.,25V,X5R	0805	Murata	GRM21BR61E106MA73L
2	C5, C6	68nF	Ceramic Cap.,50V,X7R	0603	TDK	C1608X7R1H683KT000N
1	U1	MP5094GJ	Dual Channel Current limit switch	TSOT23-8 (2mm×3mm)	MPS	MP5094GJ

## EVB TEST RESULTS

$V_{IN1}=12V$ ,  $V_{IN2}=5V$ ,  $V_{EN}=\text{Float}$ ,  $T_A=25^\circ\text{C}$ , unless otherwise noted.

**Start-Up through Input Voltage (12V Efuse)**

$I_{OUT1}=0A$

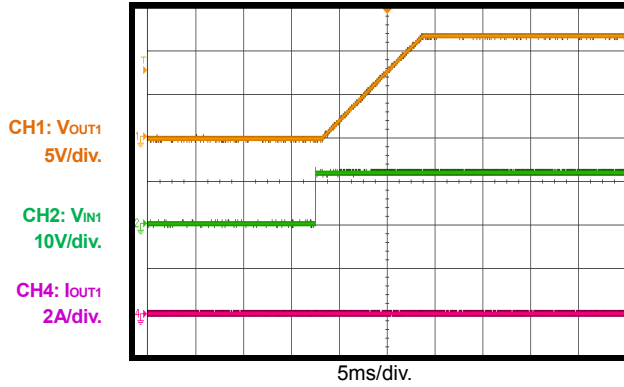

**Start-Up through Input Voltage (5V Efuse)**

$I_{OUT2}=0A$

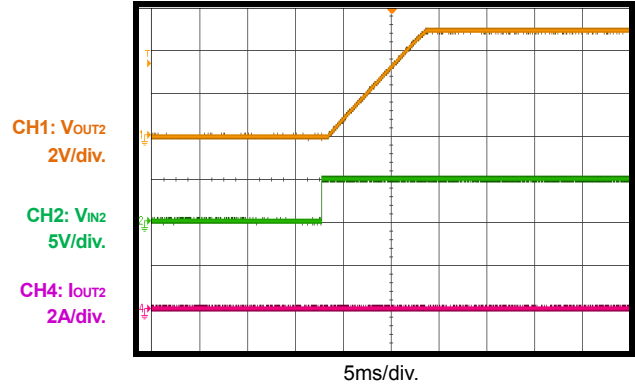

**Start-Up through Input Voltage (12V Efuse)**

$I_{OUT1}=3A$

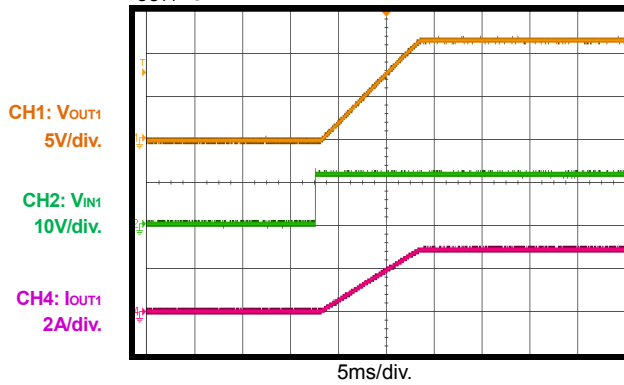

**Start-Up through Input Voltage (5V Efuse)**

$I_{OUT2}=2A$

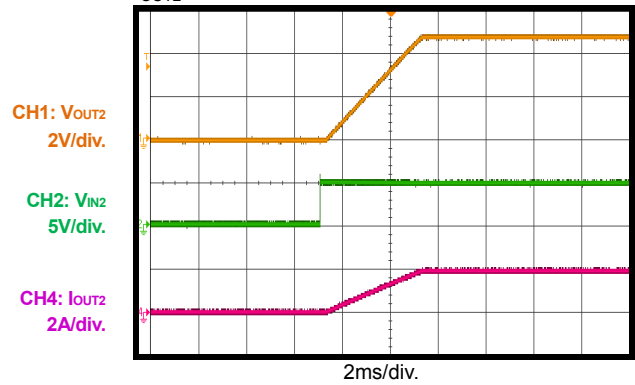

**Start-Up through Input Voltage (12V Efuse)**

$I_{OUT1}=0A$ ,  $C_{OUT1}=1000\mu\text{F}$

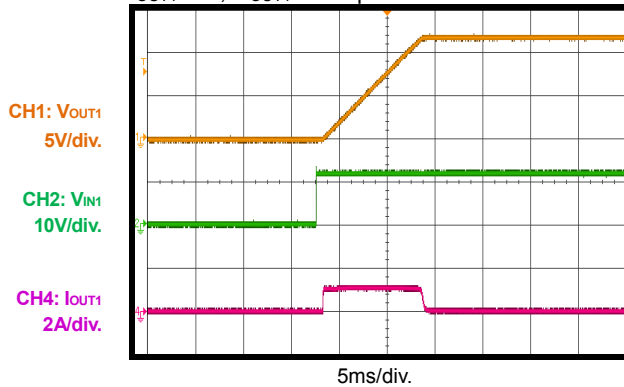

**Start-Up through Input Voltage (5V Efuse)**

$I_{OUT2}=0A$ ,  $C_{OUT2}=1000\mu\text{F}$

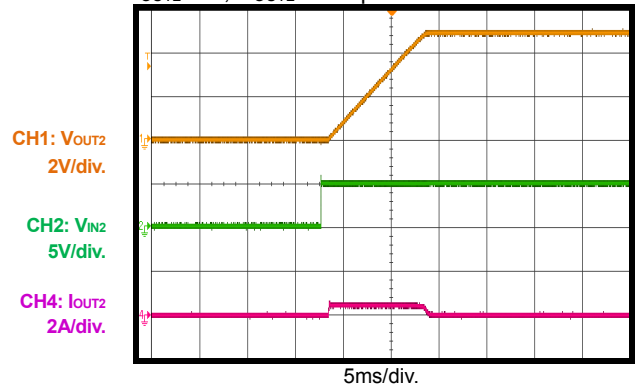

**EVB TEST RESULTS (continued)**
 $V_{IN1}=12V$ ,  $V_{IN2}=5V$ ,  $V_{EN}=\text{Float}$ ,  $T_A=25^\circ\text{C}$ , unless otherwise noted.

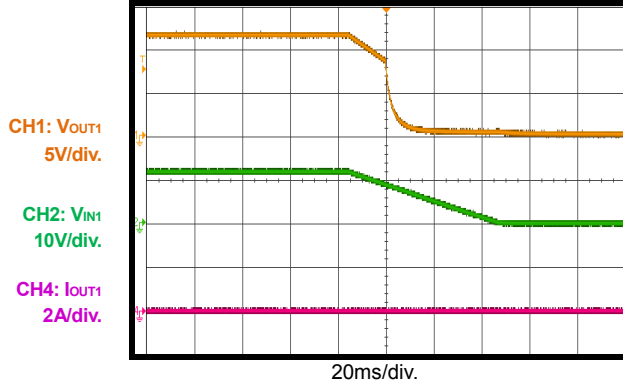
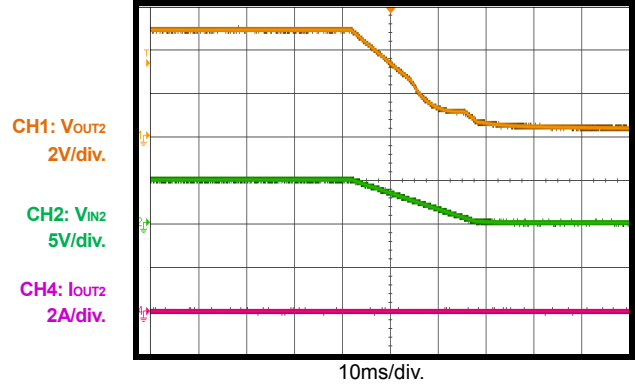
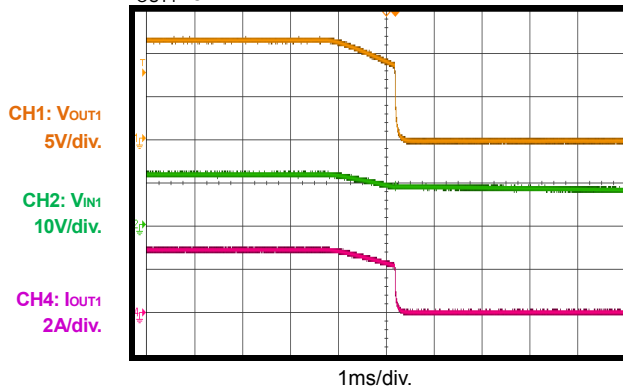
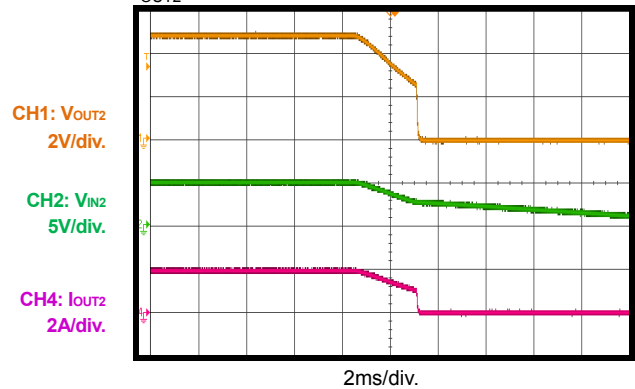
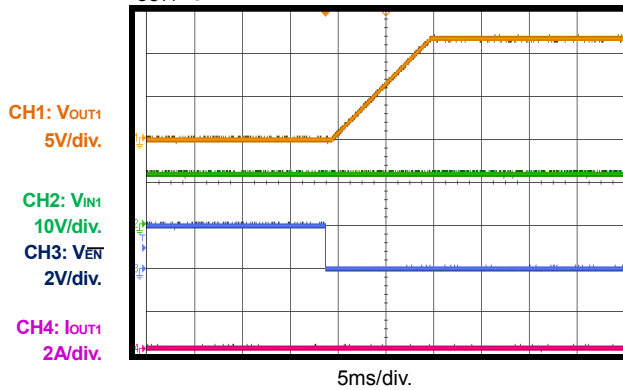
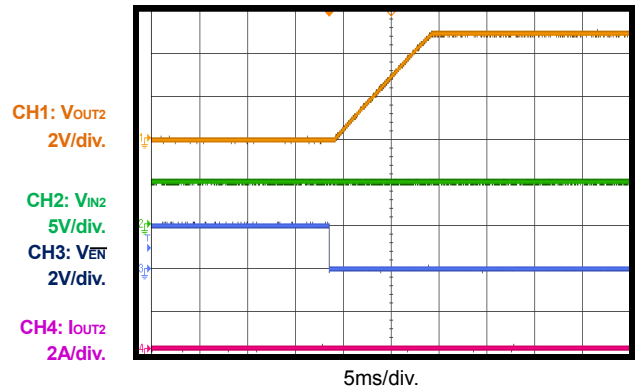
**Shutdown through Input Voltage (12V Efuse)**
 $I_{OUT1}=0A$ 

**Shutdown through Input Voltage (5V Efuse)**
 $I_{OUT2}=0A$ 

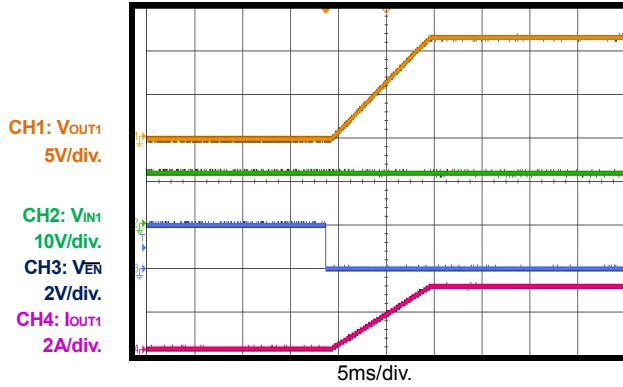
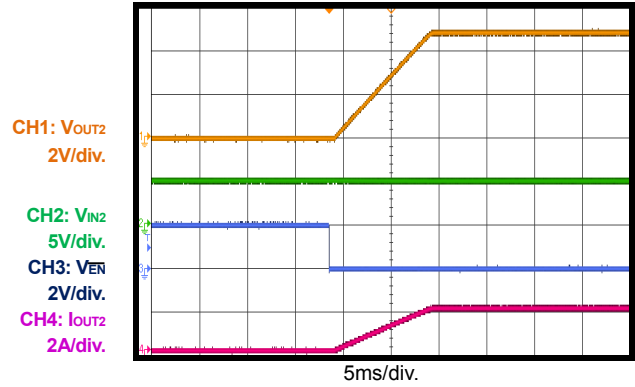
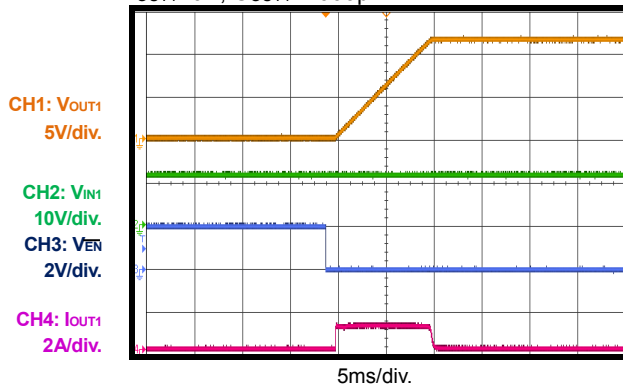
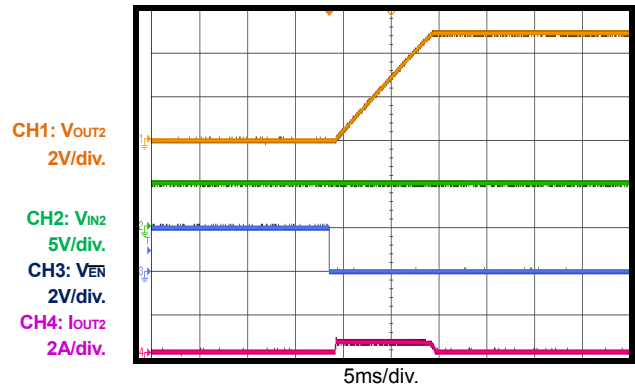
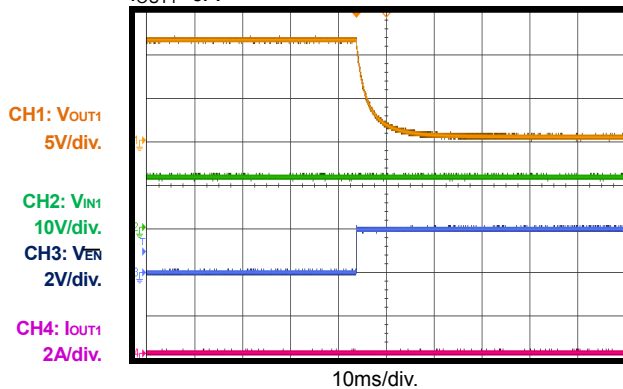
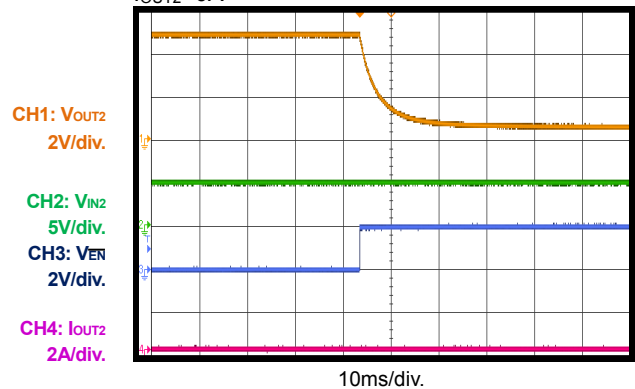
**Shutdown through Input Voltage (12V Efuse)**
 $I_{OUT1}=3A$ 

**Shutdown through Input Voltage (5V Efuse)**
 $I_{OUT2}=2A$ 

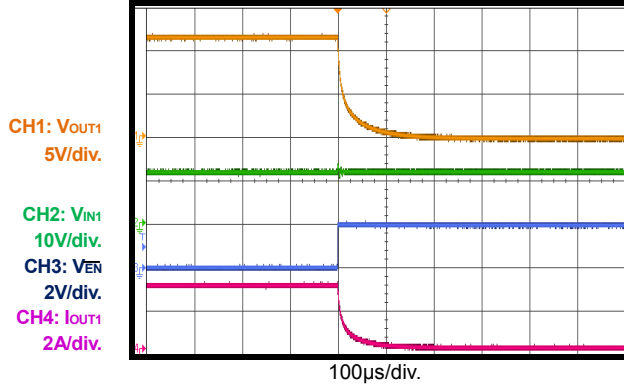
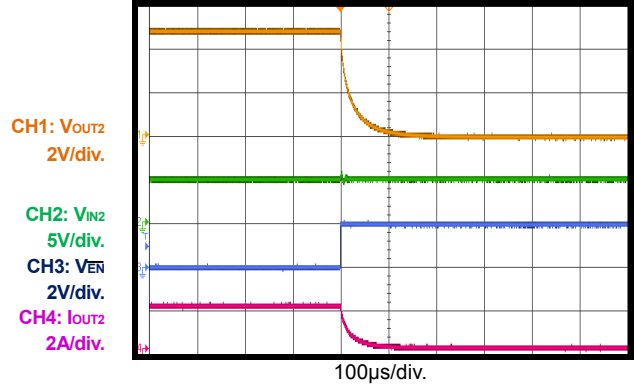
**Start-Up through Enable (12V Efuse)**
 $I_{OUT1}=0A$ 

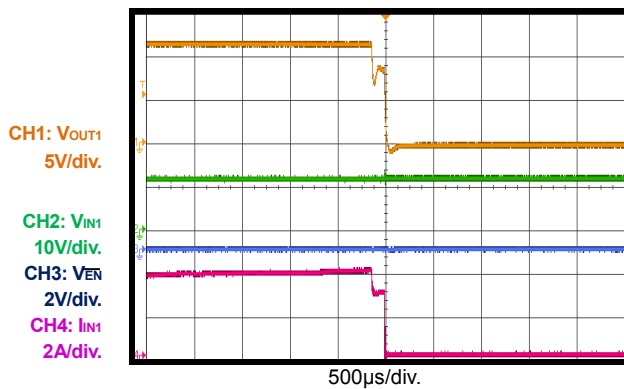
**Start-Up through Enable (5V Efuse)**
 $I_{OUT2}=0A$ 

**EVB TEST RESULTS (continued)**
 $V_{IN1}=12V$ ,  $V_{IN2}=5V$ ,  $V_{EN}=\text{Float}$ ,  $T_A=25^\circ\text{C}$ , unless otherwise noted.

**Start-Up through Enable (12V Efuse)**
 $I_{OUT1}=3A$ 

**Start-Up through Enable (5V Efuse)**
 $I_{OUT2}=2A$ 

**Start-Up through Enable (12V Efuse)**
 $I_{OUT1}=0A$ ,  $C_{OUT1}=1000\mu\text{F}$ 

**Start-Up through Enable (5V Efuse)**
 $I_{OUT2}=0A$ ,  $C_{OUT2}=1000\mu\text{F}$ 

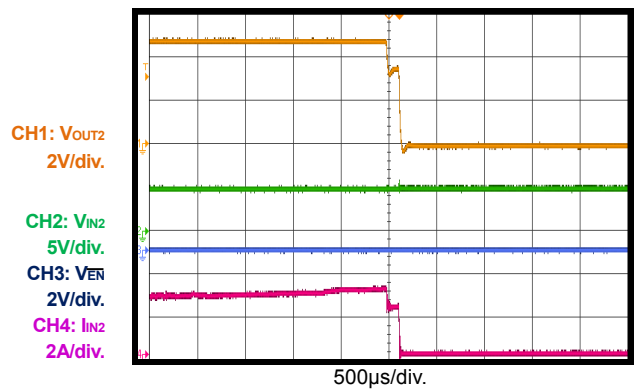
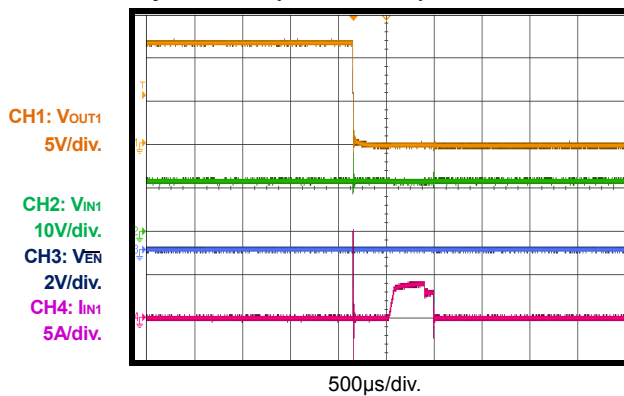
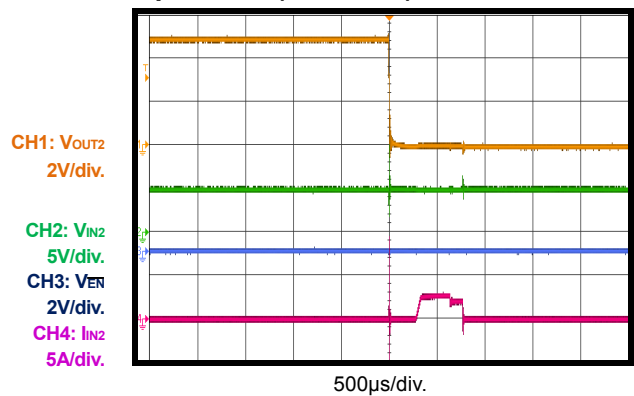
**Shutdown through Enable (12V Efuse)**
 $I_{OUT1}=0A$ 

**Shutdown through Enable (5V Efuse)**
 $I_{OUT2}=0A$ 

**EVB TEST RESULTS (continued)**
 $V_{IN1}=12V$ ,  $V_{IN2}=5V$ ,  $V_{EN}=\text{Float}$ ,  $T_A=25^\circ\text{C}$ , unless otherwise noted.

**Shutdown through Enable (12V Efuse)**
 $I_{OUT1}=3A$ 

**Shutdown through Enable (5V Efuse)**
 $I_{OUT2}=2A$ 

**Current Limit(12V Efuse)**

 Increase  $I_{OUT1}$  Slowly

**Current Limit(5V Efuse)**

 Increase  $I_{OUT2}$  Slowly

**Short Circuit during Normal Operation (12V Efuse)**

**Short Circuit during Normal Operation (5V Efuse)**

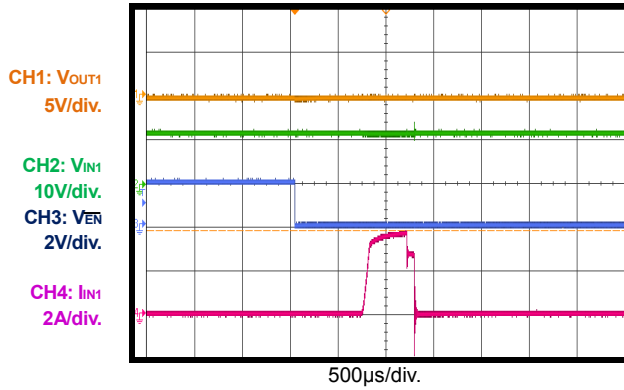
**EVB TEST RESULTS** (continued)

$V_{IN1}=12V$ ,  $V_{IN2}=5V$ ,  $V_{EN}=\text{Float}$ ,  $T_A=25^\circ\text{C}$ , unless otherwise noted.

**Short Circuit before EN Start-Up (12V Efuse)**



**Short Circuit before EN Start-Up (5V Efuse)**

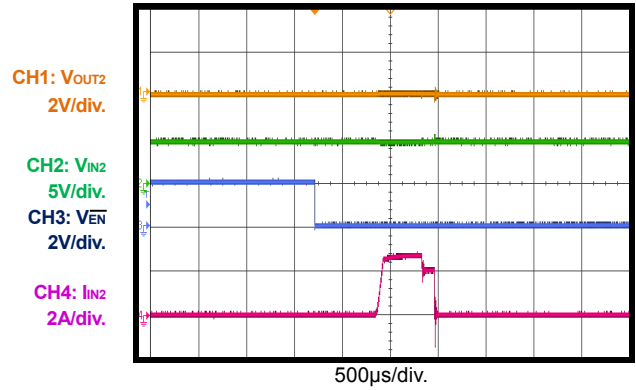

**Output Over Voltage Protection (12V Efuse)**

$V_{IN1}=12V$  to  $17V$ ,  $I_{OUT1}=1.5A$

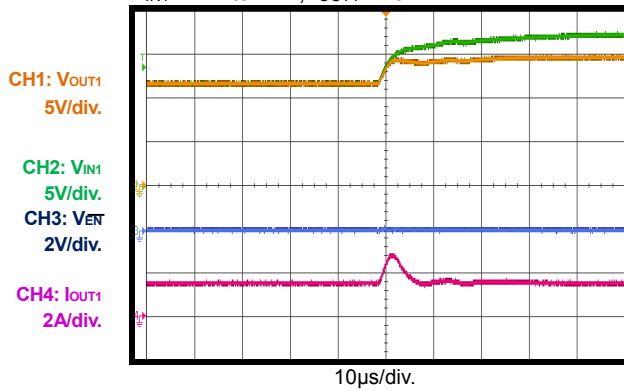

**Output Over Voltage Protection (5V Efuse)**

$V_{IN2}=5V$  to  $7V$ ,  $I_{OUT2}=1A$

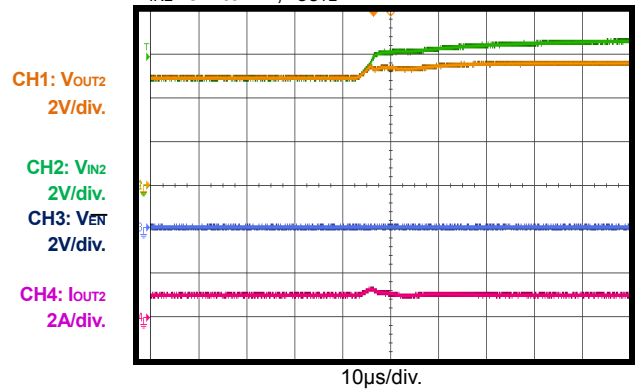

PRINTED CIRCUIT BOARD LAYOUT

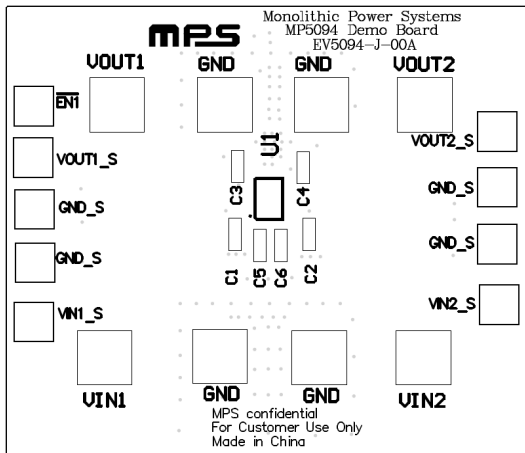

Figure 1—Top Silk Layer

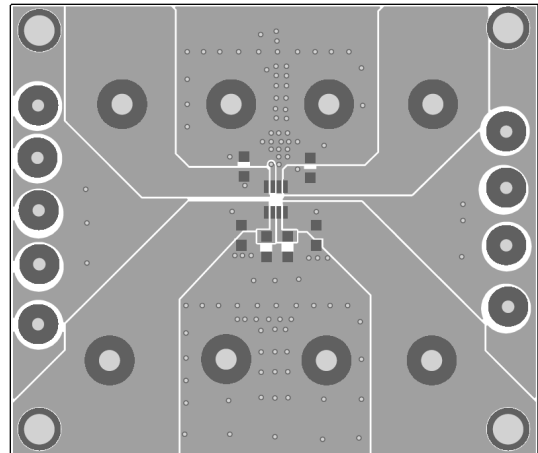

Figure 2—Top Layer

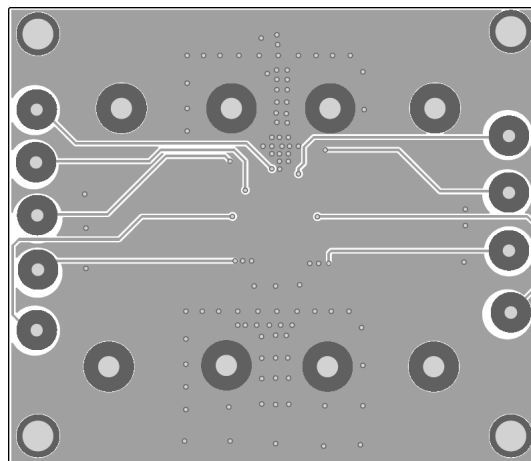

Figure 5—Bottom Layer