



The Future of Analog IC Technology®

# EV6420-J-00A

## Battery Protection IC for 2-/3-Series Cell Li-Ion with Protective MOSFET and PTC Interface

### DESCRIPTION

The EV6420-J-00A is an evaluation board for the MP6420.

The MP6420 provides overcharge protection that integrates a protective, open-drain MOSFET for 2- or 3-series cell Li-ion power systems.

The MP6420 provides a  $\pm 15\text{mV}$ , high-accuracy, overcharge threshold to monitor all series' battery pack conditions. With the high-accuracy threshold, the MP6420 can provide different fixed thresholds from 4.2V to 4.8V internally. Any cell overcharge that occurs turns on the internal protective MOSFET to indicate the error after an internally set, fixed delay time.

The MP6420 is available in a small, space-saving TSOT23-8 package.

### ELECTRICAL SPECIFICATION

Parameter	Symbol	Value	Units
Battery cells <sup>(1)</sup>	$V_B$	2-3	Serialize

**Note:**

1) For Specifications Of Lower Voltage, Please Contact Factory.

### FEATURES

- Wide  $V_{B1}$  Range from 3.6V to 18V
- Fixed Overcharge Threshold from 4.2V to 4.8V
- High-Accuracy  $\pm 15\text{mV}$  Overcharge Threshold
- Supports 2- and 3-Series Cells
- Fixed Delay Time from 2s to 8s
- Integrated 24V/100m $\Omega$  Protective MOSFETs
- Low Quiescent Current: 8 $\mu\text{A}$
- OVP Indicator FLAG and PTC Interface
- External Control CTL
- Available in a TSOT23-8 Package

### APPLICATIONS

- Battery Pack
- UPS
- Power Tool

All MPS parts are lead-free, halogen free, and adhere to the RoHS directive. For MPS green status, please visit MPS website under Quality Assurance. "MPS" and "The Future of Analog IC Technology" are Registered Trademarks of Monolithic Power Systems, Inc.

### EV6420-J-00A EVALUATION BOARD

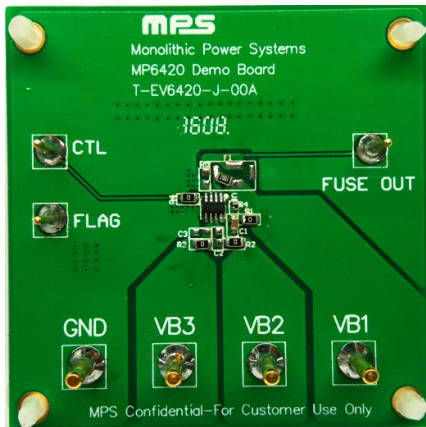

$R_{DS\_ON}$  vs.  $V_{CC}$

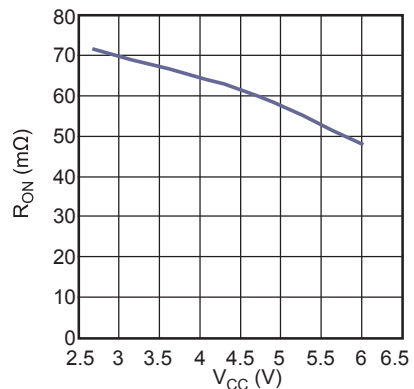

Board Number	MPS IC Number
EV6420-J-00A	MP6420GG

## EVALUATION BOARD SCHEMATIC

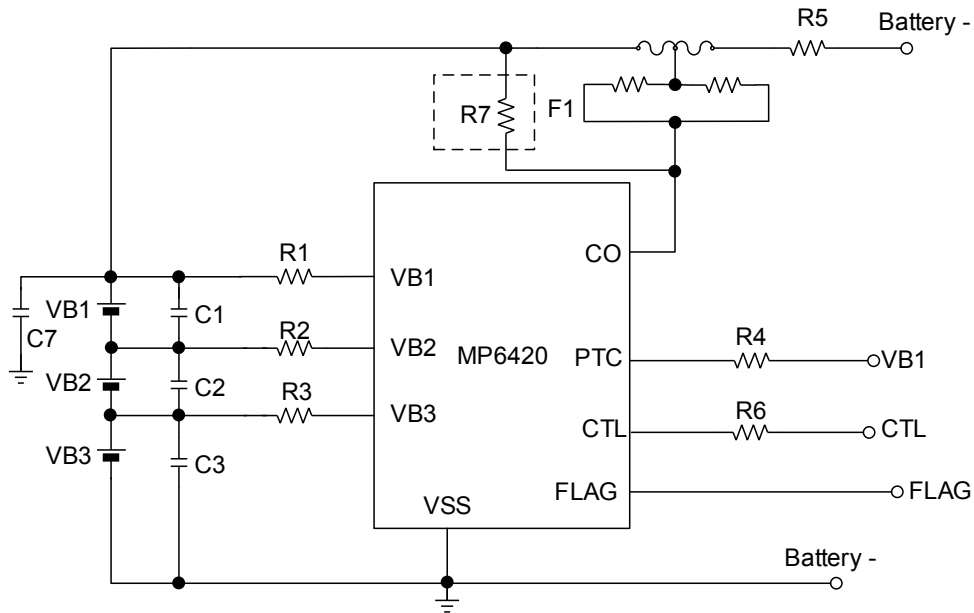

Note: R7 is the pull-up resistor of “CO” pin, just used for evaluation.

## EV6420-J-00A BILL OF MATERIALS

Qty	Ref	Value	Description	Package	Manufacturer	Part Number
1	C1	1µF	Ceramic Cap,16V,X5R	0603	muRata	GRM188R61C105KA93D
0	C2, C3	NC	Film Res,1%	0603		
5	R1,R2, R3, R5, R6	0Ω	Film Res,1%	0603	any	
1	R4	10k		0603	any	
0	F1	NC				
1	R7	10k		0603	any	
1	U1	MP6420	Battery Protection IC	TSOT23-8	MPS	MP6420

## EVB TEST RESULTS

Performance waveforms are tested on the evaluation board.

$V_{B1}$  to  $V_{B2}=V_{B2}$  to  $V_{B3}=V_{B3}$  to  $V_{SS}=4V$  with  $10k\Omega$  resistor between  $V_{B1}$  and PTC,  $T_J = 25^\circ C$ , unless otherwise noted.

**PTC Response**

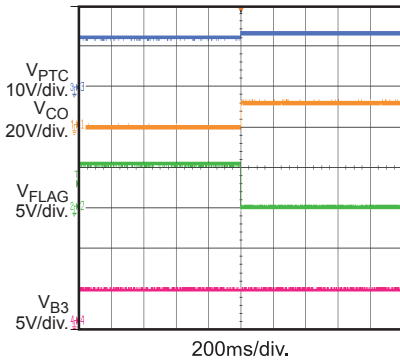

**PTC Response**

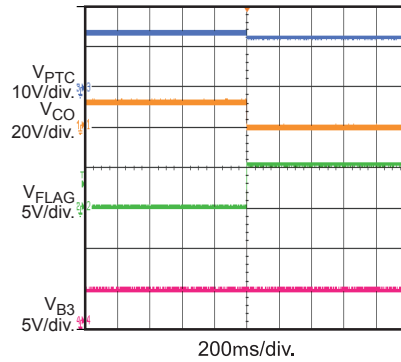

**CTL Response**

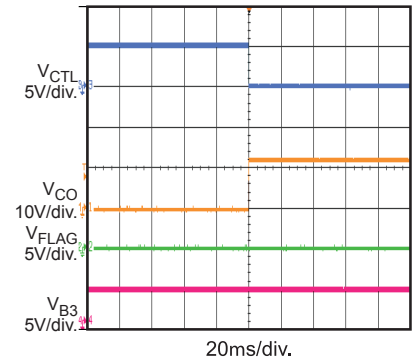

**CTL Response**

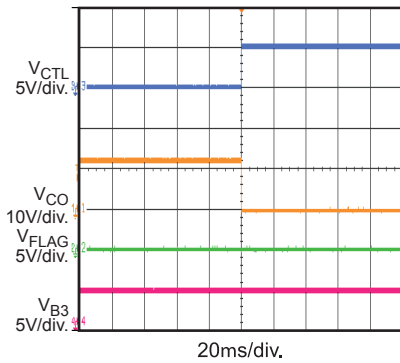

**OVP Response**

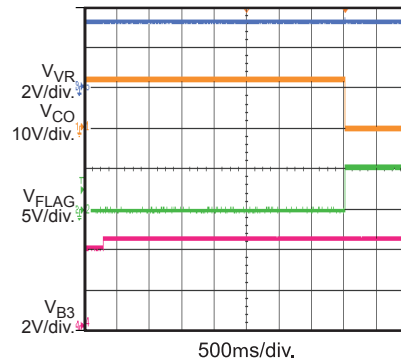

**OVP Recovery Delay**

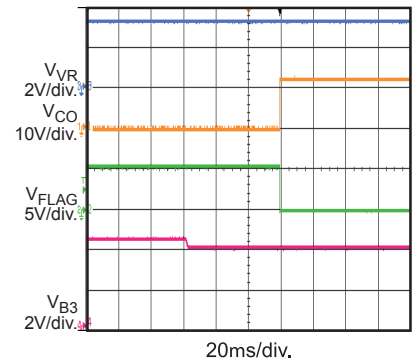

**OVP Not Recovery**

$V_{B1}$  to  $V_{B2}=V_{B2}$  to  $V_{B3}=4V$

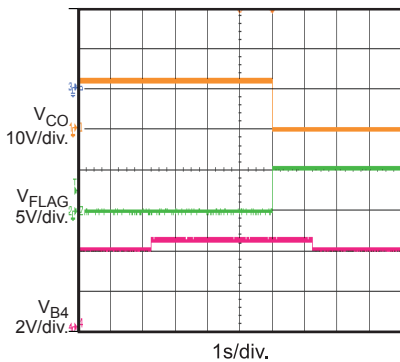

**OVP Recovery**

$V_{B1}$  to  $V_{B2}=V_{B2}$  to  $V_{B3}=3.9V$

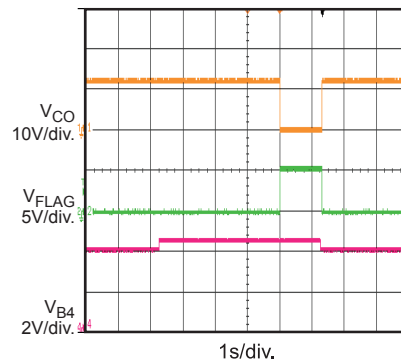

**PRINTED CIRCUIT BOARD LAYOUT**

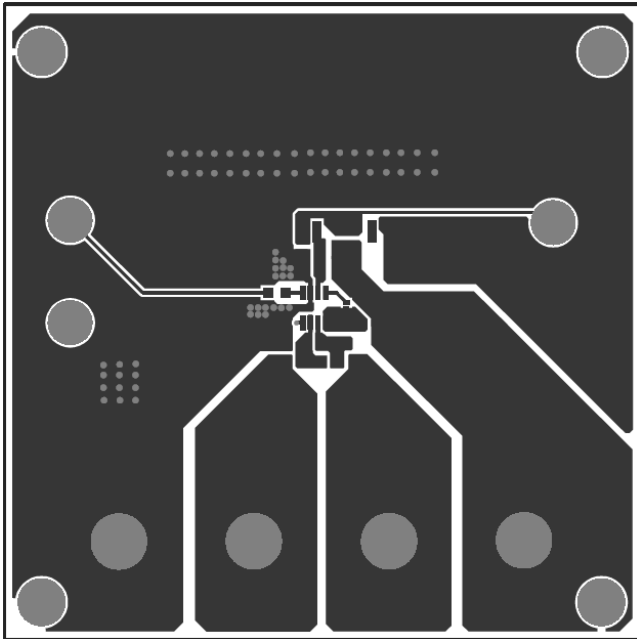

**Figure 1 - Top Layer**

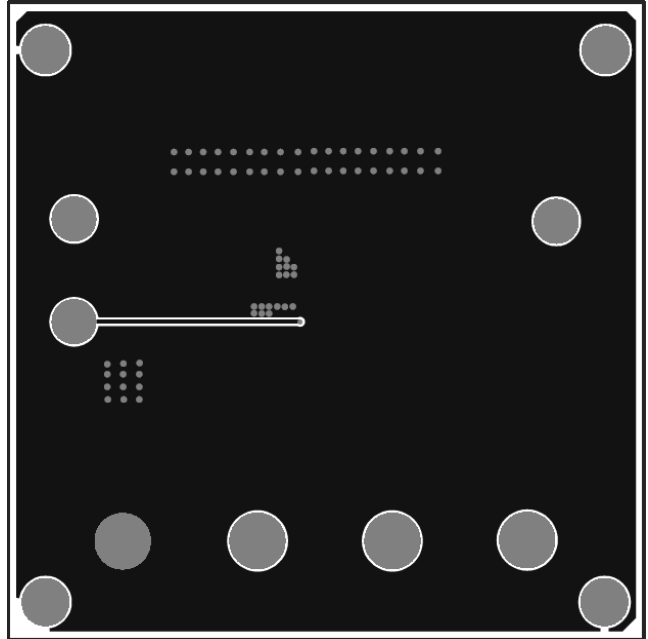

**Figure 2 - Bottom Layer**

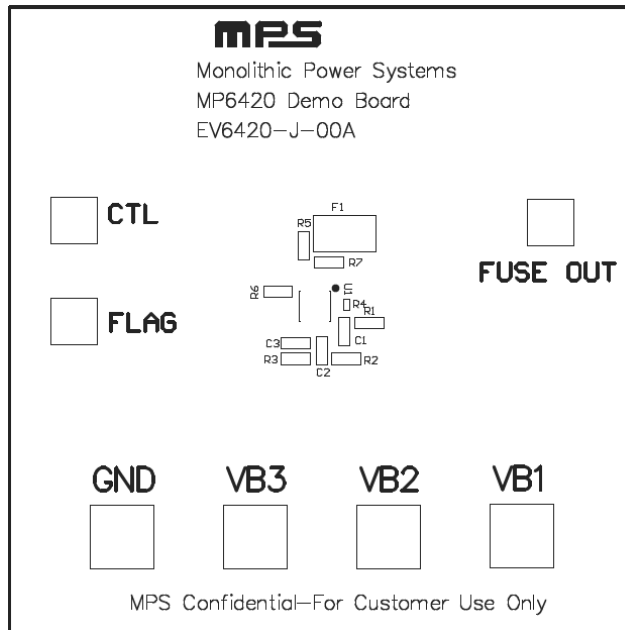

**Figure3 - Bottom Layer**