



EV6509-F-00A

1.2A, 18V, Bipolar Stepper Motor Driver Evaluation Board

DESCRIPTION

The EV6509-F-00A is an evaluation board for the MP6509GF, a bipolar stepper motor driver with dual, built-in full bridges consisting of N-channel power MOSFETs.

The device operates from a 2.7V to 18V supply voltage range, and can deliver output currents up to 1.2A per channel. The safety features include sink and source current limits implemented with external sensors, under-voltage lockout (UVLO), and thermal shutdown. An over-temperature output flag is available to indicate thermal shutdown.

The EV6509-F-00A is a fully assembled and tested PCB. The input control signals for the MP6509 are applied through the connector, or generated on the board. The board can drive a bipolar stepper motor with both full step and half-step mode. It also can drive two independent DC motors.

FEATURES

- Wide 2.7V to 18V Input Voltage Range
- Over-Current and Over-Temperature Indication
- Alternative Input Control Signals (External or Generated on Board)
- Four Selectable Current Attenuation Modes

APPLICATIONS

- POS Printers
- Video Security Cameras
- Battery-Powered Devices
- USB-Powered Devices

All MPS parts are lead-free, halogen-free, and adhere to the RoHS directive. For MPS green status, please visit the MPS website under Quality Assurance. "MPS", the MPS logo, and "Simple, Easy Solutions" are trademarks of Monolithic Power Systems, Inc. or its subsidiaries.

ELECTRICAL SPECIFICATIONS

Parameter	Symbol	Value	Units
Input voltage	V_{IN}	2.7 to 18	V
Output current	I_{OUT}	1.2	A

EV6509-F-00A EVALUATION BOARD

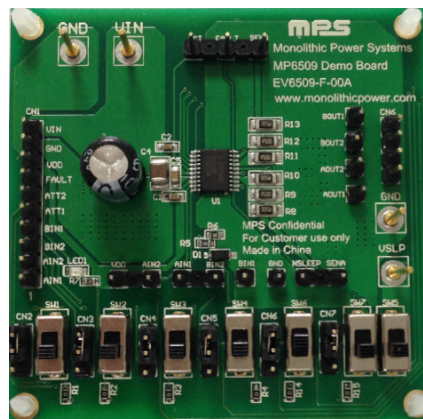

(LxWxH) 6.35cmx6.35cmx1cm

Board Number	MPS IC Number
EV6509-F-00A	MP6509GF

QUICK START GUIDE

1. The power and control signals for the MP6509 are applied through connector CN1. Each pin in the connector is labeled on the EVB. The control signals for AIN1, AIN2, BIN1, and BIN2 can be generated on the board (see step 5 for more detailed information). CN1 also outputs the FAULT signal and V_{DD} (5V) from the IC.
2. Preset the power supply (2.7V to 18V) between either the VIN and GND pins on CN1, or the external VIN and GND terminals.
3. Connector CN6 should be connected to the motor winding terminals. Each pin in the connector is labeled on the EVB as AOUT1, AOUT2, BOUT1, and BOUT2. The polarity of these connections affects the direction of the DC motor. For a stepper motor, one winding should be connected to AOUT1 and AOUT2, while the other should be connected to BOUT1 and BOUT2.
4. If SW5 is switched to the VIN position (top side), the SLEEP pin is pulled up to V_{IN} by a resistor divider. This ensures that the part does not enter sleep mode. If sleep mode is controlled externally, switch SW5 to the VSLP position (bottom side), and connect the SLEEP control signal from the external controller directly to the VSLP terminal.
5. Jumpers (CN2, CN3, CN4, and CN5) are used to select the source of the control signals (AIN1, AIN2, BIN2, and BIN1, respectively).

By placing a shunt between positions 1 and 2, the source of the control signals is routed to connector CN1. This connection allows the user to control these signals through an external controller.

If the shunt is placed between positions 2 and 3, the source of the control signals are routed to the switches (SW1, SW2, SW3, SW4, SW6, and SW7). These switches can be used to set the state of the input control signals. Refer to the MP6509 datasheet for more details on the state of the motor outputs for various input combinations.

6. Diode LED1 indicates the FAULT pin status. If over-current protection (OCP) or over-temperature protection (OTP) occurs, the FAULT pin is pulled low, and the LED lights up.
7. R8, R9, and R10, as well as R11, R12, and R13 are the current-sense resistors connected directly to SENA and SENB, respectively. The other sides of these resistors are connected to GND. These resistors control the current through the MP6509, which is set to be 1.2A per channel. To change the output current, the resistor values must also be changed. The relationship between the output current limit and R8 through R10, and R11 through R13, can be calculated with Equation (1) and Equation (2), respectively:

$$I_{LIM-A} = \frac{200mV}{R8//R9//R10} \quad (1)$$

$$I_{LIM-B} = \frac{200mV}{R11//R12//R13} \quad (2)$$

EVALUATION BOARD SCHEMATIC

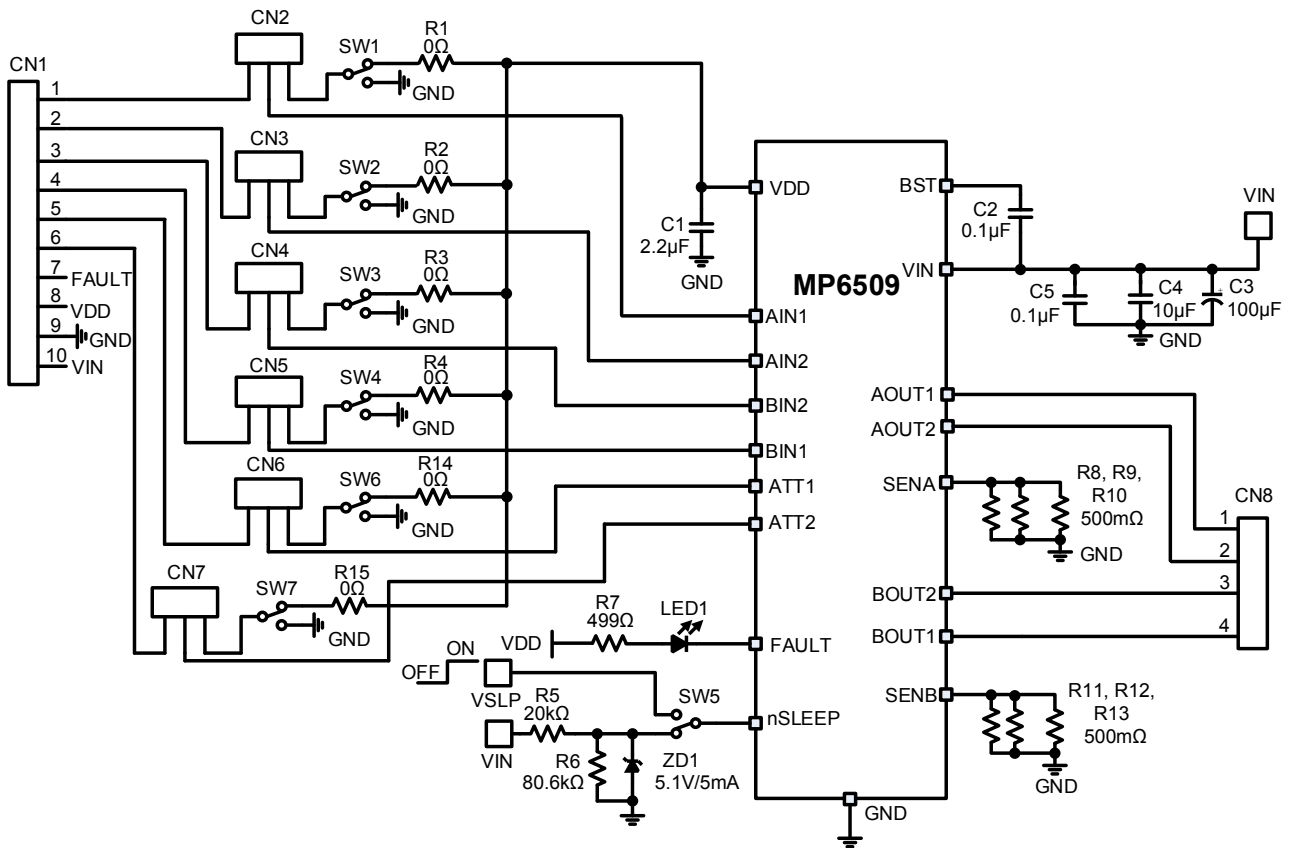

Figure 1: Evaluation Board Schematic

EV6509-F-00A BILL OF MATERIALS

Qty	Ref	Value	Description	Package	Manufacturer	Manufacturer P/N
1	C1	2.2 μ F	Ceramic capacitor, 10V, X7R	0603	Murata	GRM188R71A225KE15D
2	C2, C5	0.1 μ F	Ceramic capacitor, 25V, X7R	0603	Murata	GRM188R71E104KA01D
1	C3	100 μ F	Electrolytic capacitor, 50V, X5R	DIP	Jianghai	CD287-50V100
1	C4	10 μ F	Ceramic capacitor, 50V, X7R	1206	Murata	GRM32ER71H106KA12L
6	R1, R2, R3, R4, R14, R15	0 Ω	Film resistor, 5%	0603	Royal Ohm	0603J0000T5E
1	R5	20k Ω	Film resistor, 1%	0603	Yageo	RC0603FR-0720KL
1	R6	80.6k Ω	Film resistor, 1%	0603	Yageo	RC0603FR-0780K6L
1	R7	499 Ω	Film resistor, 1%	0603	Yageo	RC0603FR-07499RL
6	R8, R9, R10, R11, R12, R13	500m Ω	Film resistor, 1%	1206	Yageo	RL1206FR-070R5L
1	ZD1	5.1V, 5mA	Zener diode	SOD-123	Diodes	BZT52C5V1
1	LED1	Red	LED	0805	Bright LED	BL-HUF35A-TRB
7	SW1, SW2, SW3, SW4, SW5, SW6, SW7	SPDT	Button	DIP	Any	
1	CN1	10-bits/ 2.54mm	Connector	DIP	Any	
6	CN2, CN3, CN4, CN5, CN6, CN7	3-bits/ 2.54mm	Connector	DIP	Any	
6	CN2, CN3, CN4, CN5, CN6, CN7	2.54mm	Short jumper	DIP	Any	
1	CN8	4-bits/ 2.54mm	Connector	DIP	Any	
4	VIN, VSLP, GND, GND	$\Phi = 1$ mm	Connector	DIP	Any	
1	U1	18V, 1.2A	Stepper motor driver	TSSOP-20 EP	MPS	MP6509GF

EVB TEST RESULTS

Performance waveforms are tested on the evaluation board, $V_{IN} = 12V$, $I_{OUT} = 1.2A$, $ATT1 = ATT2 = L$, $f_{STEP} = 200Hz$, R + L load: L = 1.5mH, R = 3.3Ω, $T_A = 25^\circ C$, unless otherwise noted.

Steady State (Full Step)

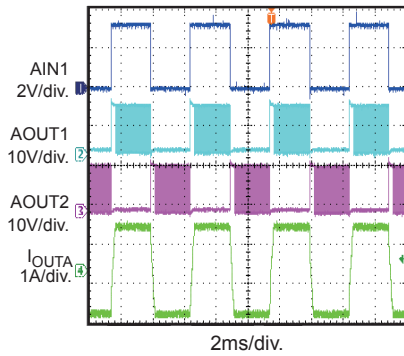

Steady State (Half-Step)

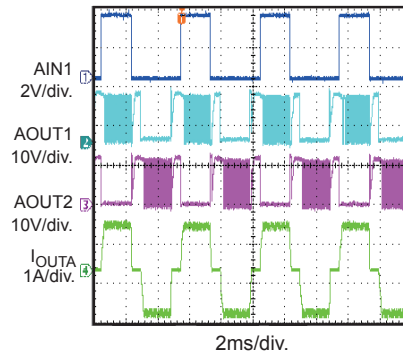

Power Ramp Up (Full Step)

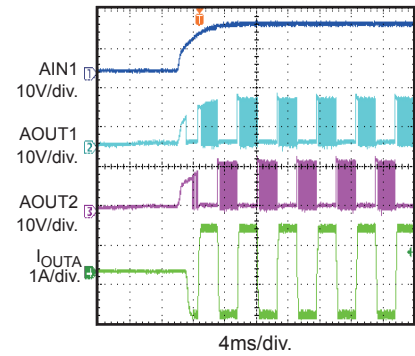

Power Ramp Up (Half-Step)

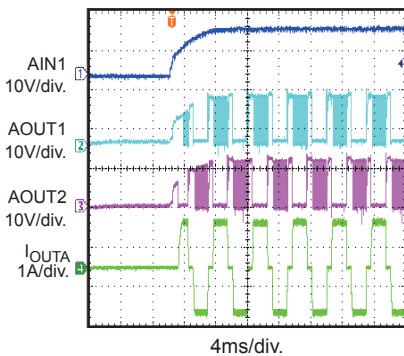

Sleep Entry (Full Step)

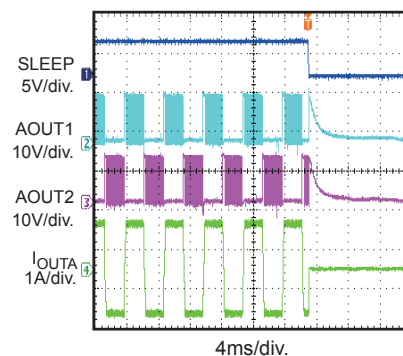

Sleep Recovery (Full Step)

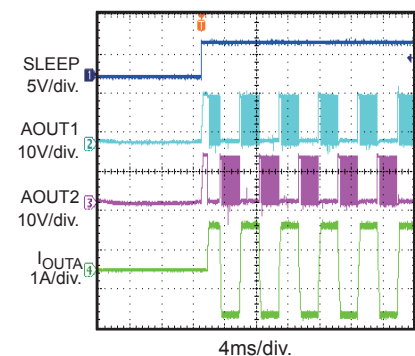

Sleep Entry (Half-Step)

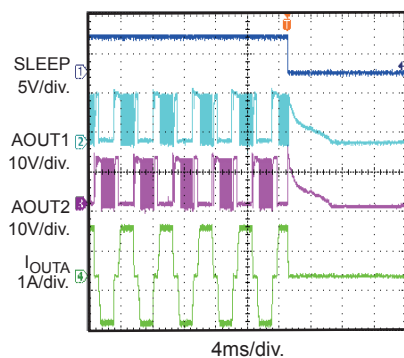

Sleep Recovery (Half-Step)

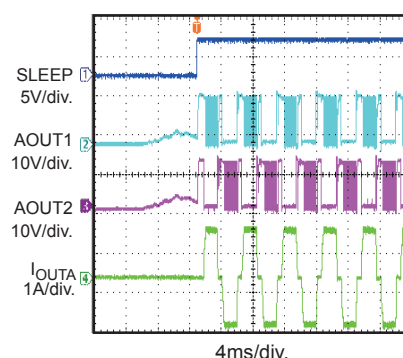

80% Current Attenuation (Full Step)

ATT1 = H, ATT2 = L

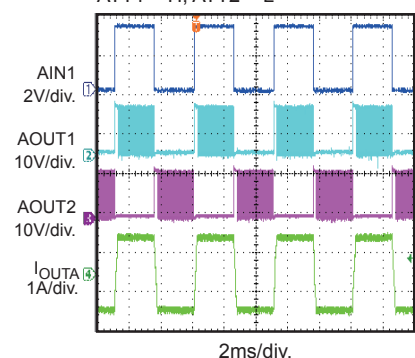

EVB TEST RESULTS *(continued)*

Performance waveforms are tested on the evaluation board, $V_{IN} = 12V$, $I_{OUT} = 1.2A$, $ATT1 = ATT2 = L$, $f_{STEP} = 200Hz$, R + L load: L = 1.5mH, R = 3.3Ω, $T_A = 25^\circ C$, unless otherwise noted.

80% Current Attenuation (Half-Step)

ATT1 = H, ATT2 = L

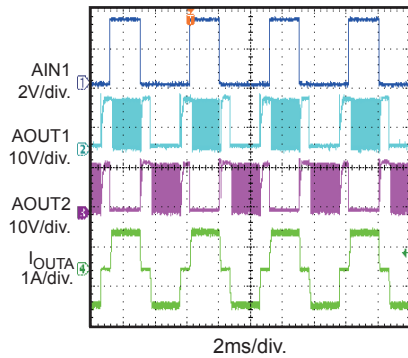

50% Current Attenuation (Full Step)

ATT1 = L, ATT2 = H

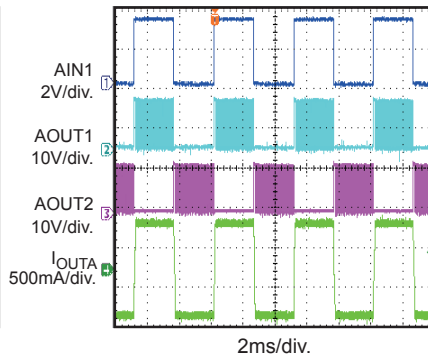

50% Current Attenuation (Half-Step)

ATT1 = L, ATT2 = H

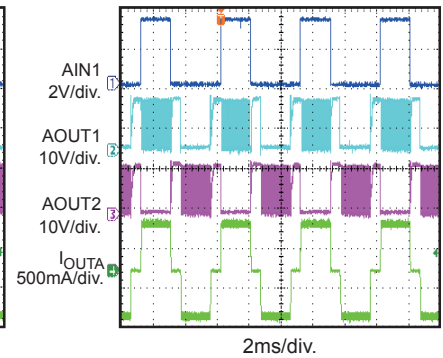

20% Current Attenuation (Full Step)

ATT1 = H, ATT2 = H

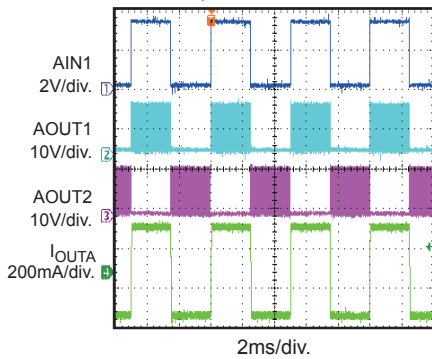

20% Current Attenuation (Half-Step)

ATT1 = H, ATT2 = H

