

### DESCRIPTION

The EV7722DF-02A is the evaluation board for the MP7722. The MP7722 is a stereo 20W Class D Audio Amplifier. It is one of MPS' second generation of fully integrated audio amplifiers which dramatically reduces solution size by integrating the following:

- 180mΩ power MOSFETs
- Startup / Shutdown pop elimination
- Short circuit protection circuits
- Mute / Standby

The MP7722 utilizes a single ended output structure with capacitor divider configuration capable of delivering 2x20W into 4Ω speakers. MPS Class D Audio Amplifiers exhibit the high fidelity of a Class A/B amplifier at efficiencies greater than 90%. The circuit is based on the MPS' AAM™ proprietary variable frequency topology that delivers excellent linearity, fast response time and operates on a single power supply.

### ELECTRICAL SPECIFICATIONS

Parameter	Symbol	Value	Units
Supply Voltage	V <sub>DD</sub>	24	V

### FEATURES

- 20W Output at V<sub>DD</sub> = 24V into a 4Ω load
- THD+N = 0.08% at 1W, 8Ω
- 90% Efficiency at 20W
- 9.5V to 24V Operation from a Single Supply
- Mute/Standby Modes (Sleep)

### APPLICATIONS

- Flat Panel and Projection Televisions
- DVD and Surround Sound Systems
- Flat Panel Monitors
- Multimedia Computers
- Home Stereo Systems

"MPS" and "The Future of Analog IC Technology" are Registered Trademarks of Monolithic Power Systems, Inc.

AAM (Analog Adaptive Modulation) is a Trademark of Monolithic Power Systems, Inc.

### EV7722DF-02A EVALUATION BOARD



(L x W x H) 3.5" x 2.4" x 1.2"  
8.9cm x 6.1cm x 3.0cm

Board Number	MPS IC Number
EV7722DF-02A	MP7722DF

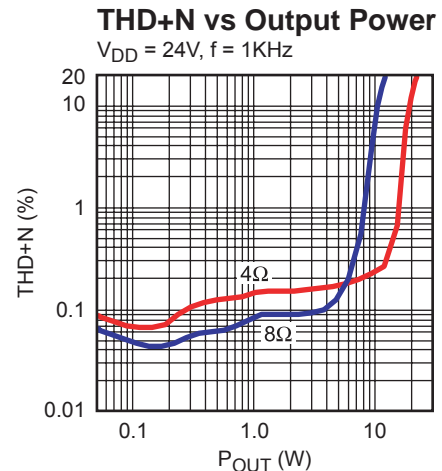

EVALUATION BOARD SCHEMATIC

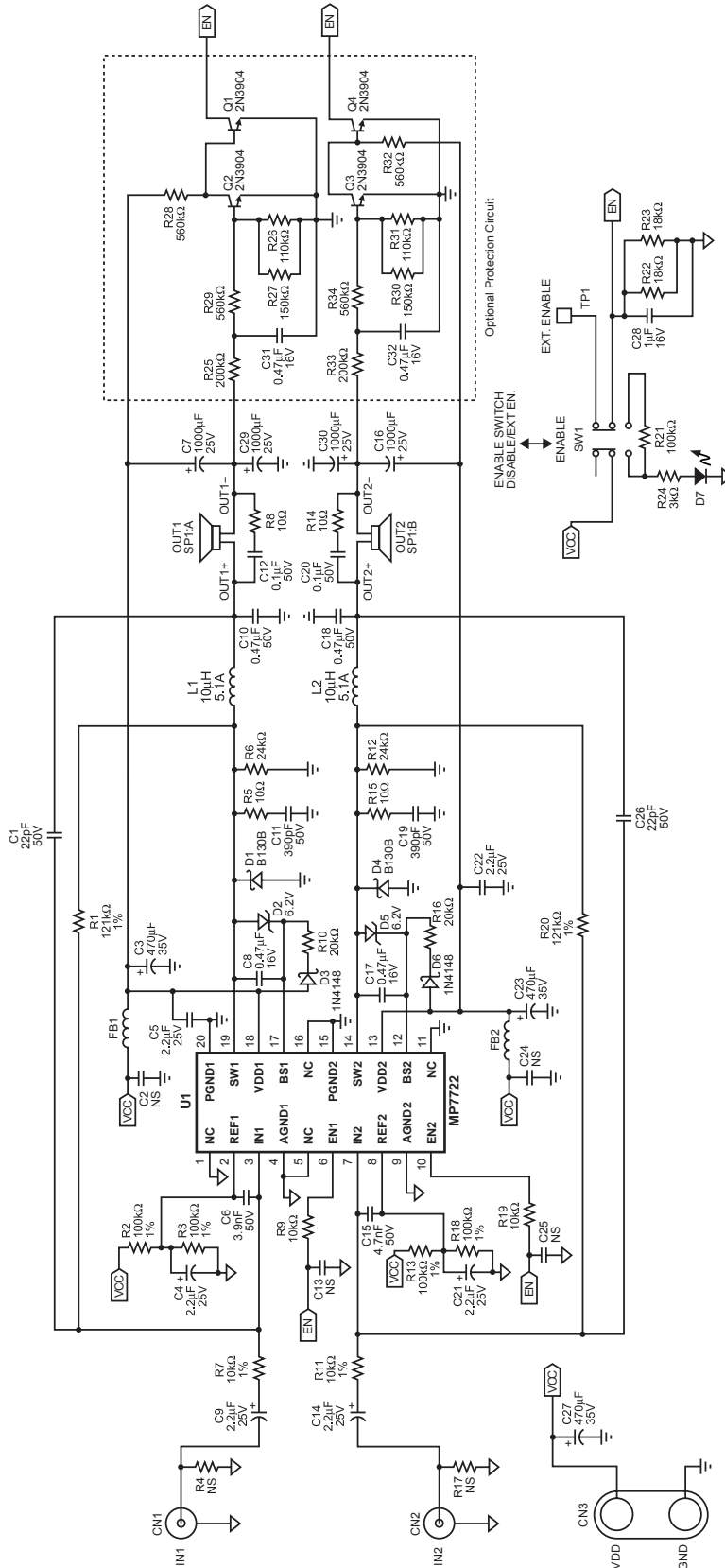

**EV7722DF-02A BILL OF MATERIALS**

Qty	Ref	Value	Description	Package	Manufacturer P/N
2	C1, C26	22pF	Ceramic Capacitor, 50V, C0G	0603	Murata: GRM1885C1H220JA01
4	C2, C13, C25, C24		Not stuffed		
3	C3, C23, C27	470µF	Electrolytic Capacitor, 470uF, 35V, YXF	Radial	Rubycon: 35YXF470M
4	C4, C9, C14, C21	2.2µF	Electrolytic Capacitor, 25V, YXF	Radial	Rubycon: 25YXF2M2
2	C5, C22	2.2µF	Ceramic Capacitor, 25V, X7R	1206	Murata: GRM31MR71E225KA93
1	C6	3.9nF	Ceramic Capacitor, 50V, X7R	0603	Murata: GRM188R71H392KA01
4	C7, C16, C29, C30	1000µF	Electrolytic Capacitor, 25V, YXF	Radial	Rubycon: 25VYXF1000M
4	C8, C17, C31, C32	0.47µF	Ceramic Capacitor, 16V, X7R	0603	Murata: GRM188R71C474KA88D
2	C10, C18	0.47µF	Film Capacitor, 50V, X7R	Radial	Any
2	C11, C19	390pF	Ceramic Capacitor, 50V, C0G	0603	Murata: GRM1885C1H3901JA01
2	C12, C20	0.1µF	Ceramic Capacitor, 50V, X7R	0603	Murata: GRM188R71H104KA993D
1	C15	4.7nF	Ceramic Capacitor, 50V, X7R	0603	Murata: GRM188R71H472KA01
1	C28	1µF	Ceramic Capacitor, 16V, X7R	0805	Murata: GRM21BR71C105KA01L
2	CN1, CN2		Phone Jack, Female	RCA	Any
1	CN3		Banana Jack Connector		Any
2	D1, D4		Schottky Diode, 1A/30V	SMB	Diodes: B130B-13-F
2	D2, D5	6.2V	Zener Diode, 6.2V/250mW	SOD323	Diodes Inc.: BZT52C6V2S
2	D3, D6		Diode Switch, 75V, 100mA	SOD323	Diodes: 1N4148
1	D7		LED	1206	Any
2	FB1, FB2		Fuse, Ferrite Bead, 4A	BS43	Toko: BS43
2	L1, L2	10µH	Inductor (13RHBP), 5.1A	Radial	Toko: 13RHBP-A7502BY-100M
4	Q1, Q2, Q3, Q4		NPN Transistor, 2N3904	SOT23	On Semi: MMBT3904

**EV7722DF-02A BILL OF MATERIALS (continued)**

Qty	Ref	Value	Description	Package	Manufacturer P/N
2	R1, R20	121kΩ	Resistor, 1%	0603	Yageo: RC0603FR-07120KL
4	R2, R3, R13, R18	100kΩ	Resistor, 1%	0603	Yageo: RC0603FR-07100KL
2	R4, R17	NS	Not Stuffed		
2	R5, R15	10Ω	Resistor, 5%	0603	Yageo: RC0603JR-0710RL
2	R6, R12	24kΩ	Resistor, 5%	0603	Yageo: RC0603JR-0725RL
2	R7, R11	10kΩ	Resistor, 1%	0603	Yageo: RC0603FR-0710KL
2	R8, R14	10Ω	Resistor, 5%	1206	Yageo: RC1206JR-0710RL
2	R9, R19	10kΩ	Resistor, 5%	0603	Yageo: RC0603JR-0710KL
2	R10, R16	20kΩ	Resistor, 5%	0603	Yageo: RC0603JR-0720KL
1	R21	100kΩ	Resistor, 5%	0603	Yageo: RC0603JR-07100KL
2	R22,R23	18kΩ	Resistor, 5%	0603	Yageo: RC0603JR-0718KL
1	R24	3kΩ	Resistor, 5%	0603	Yageo: RC0603JR-073KL
2	R25, R33	200kΩ	Resistor, 5%	0603	Yageo: RC0603JR-07200KL
4	R28, R29, R32, R34	560kΩ	Resistor, 5%	0603	Yageo: RC0603JR-07560KL
2	R26, R31	110kΩ	Resistor, 5%	0603	Any
2	R27, R30	150kΩ	Resistor, 5%	0603	Any
1	SP1		Speaker Connector, Red and Black		Any
1	SW1		Switch slide, 12V, 0.1A		Any
1	TP1		Pin (Test Point)		Any
1	U1		MPS AUDIO IC MP7722DF	TSSOP20F	MPS: MP7722DF

### TYPICAL PERFORMANCE CHARACTERISTICS

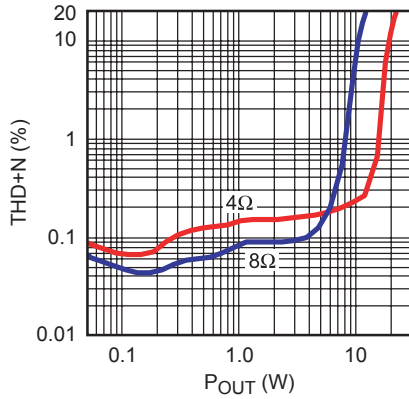
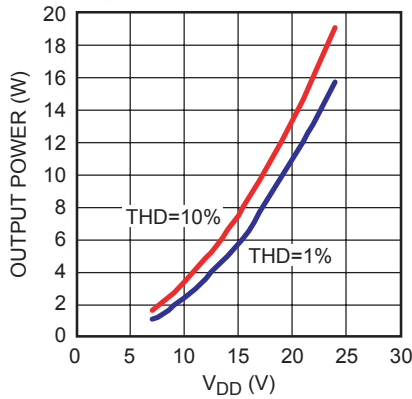
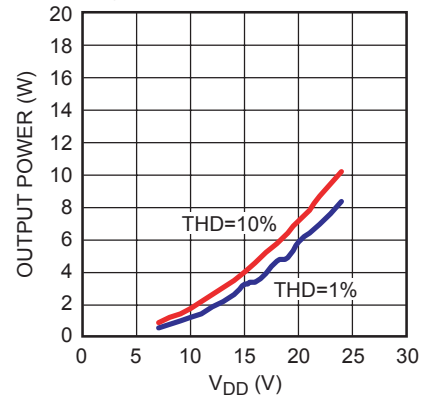
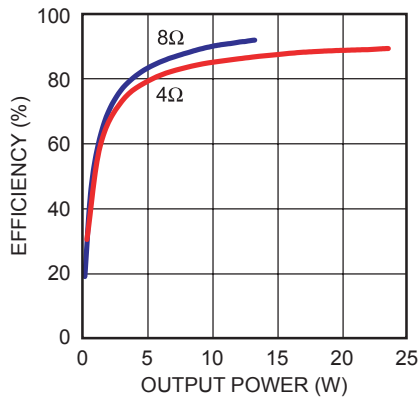
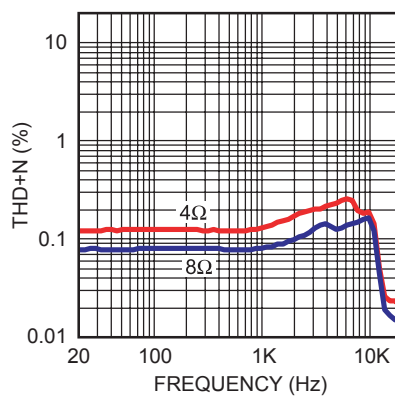
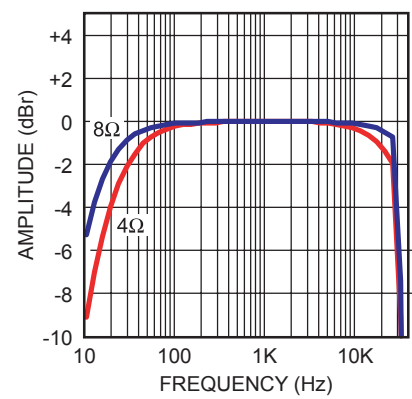
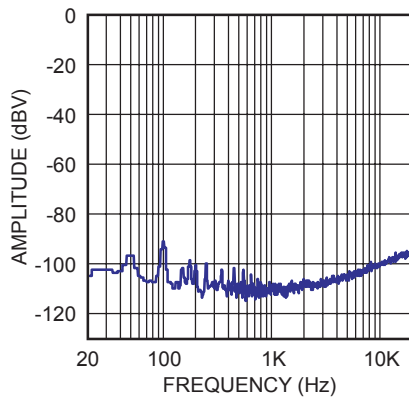
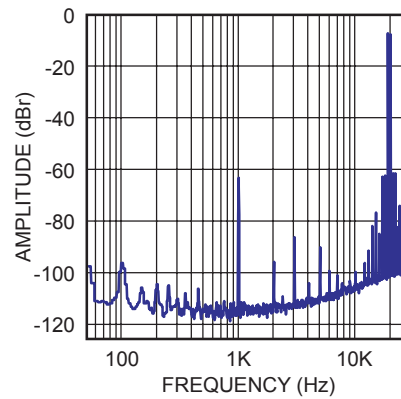
**THD+N vs Output Power**
 $V_{DD} = 24V, f = 1KHz$ 

**Output Power vs  $V_{DD}$** 
 $R_{LOAD} = 4\Omega, f = 1KHz$ 

**Output Power vs  $V_{DD}$** 
 $R_{LOAD} = 8\Omega, f = 1KHz$ 

**Efficiency vs Output Power**
 $V_{DD} = 24V$ 

**THD+N vs Frequency**
 $V_{DD} = 24V, 1W$ 

**Frequency Response**
 $V_{DD} = 24V, A_V = 12$ 

**FFT Noise Floor**
 $V_{DD} = 24V, A\text{-wtd}, 4\Omega$ 

**IHF-IMD**
 $V_{DD} = 24V, A\text{-wtd}, 4\Omega, A_V = 12$ 

PRINTED CIRCUIT BOARD LAYOUT

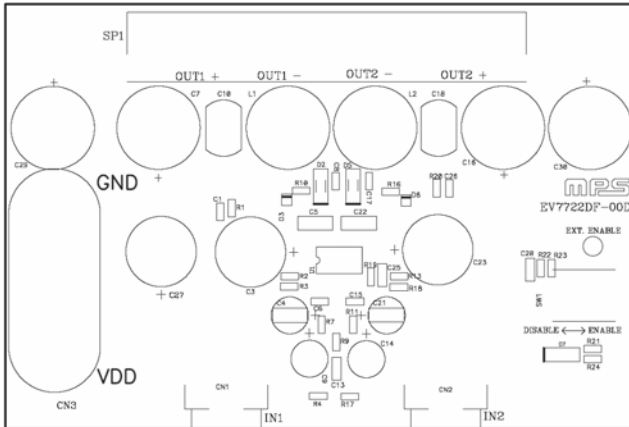

Figure 1—Top Silk Layer

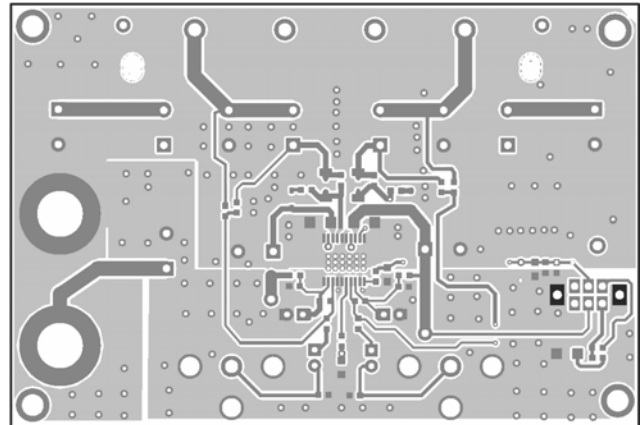

Figure 2—Top Layer

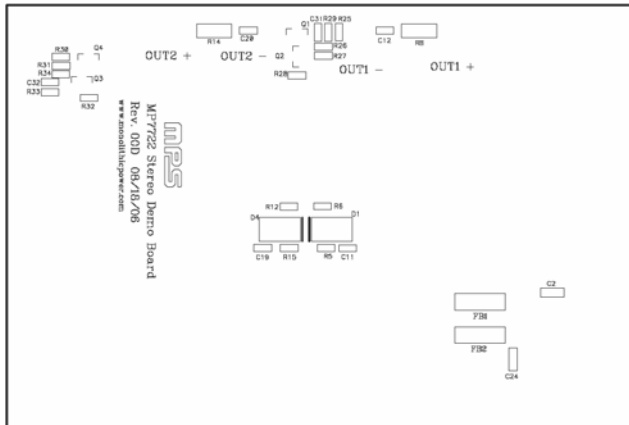

Figure 3—Bottom Silk Layer

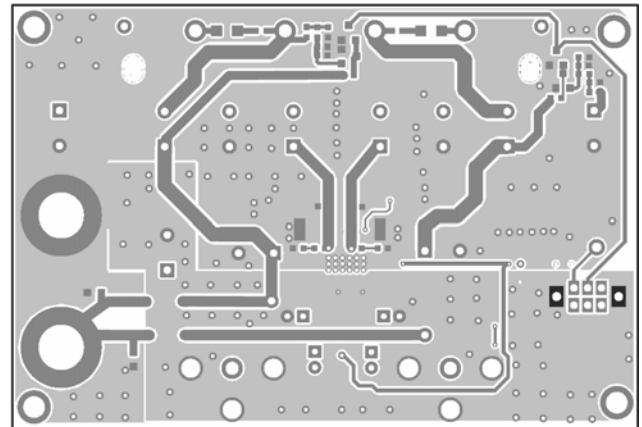

Figure 4—Bottom and Bottom Silk Layer

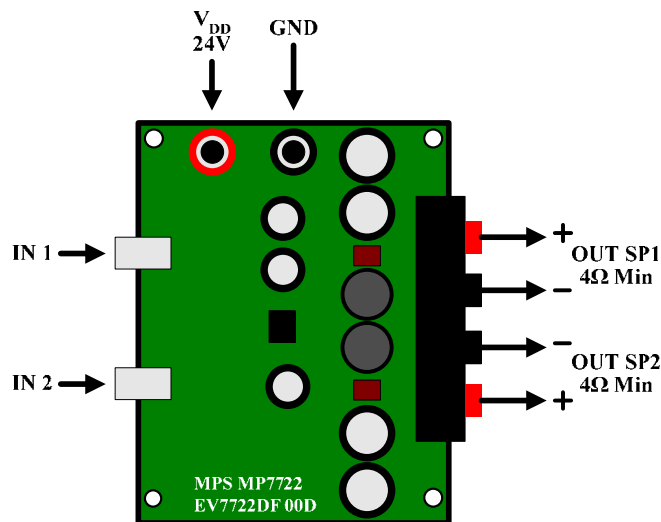

Figure 5—Connection Diagram