



EV8007H-V-00A

IEEE 802.3af PoE PD Interface with 13W Primary-Side Regulated Flyback Converter Evaluation Board

DESCRIPTION

The EV8007H-V-00A evaluation board is designed to demonstrate the capability of the MP8007H's primary-side regulated flyback function. This board supports IEEE 802.3af PoE compliant powered devices (PDs) with a PD interface and flyback power converter. It is targeted for isolated, 13W PoE application.

The PD interface has all the functions of IEEE 802.3af, including detection, classification, inrush current, operation current, and a 100V hot-swap MOSFET. The DC/DC converter uses a fixed peak current and variable frequency discontinuous conduction mode (DCM) to regulate constant output voltage.

The MP8007H is available in a QFN-28 (4mmx5mm) package.

ELECTRICAL SPECIFICATIONS

Parameter	Symbol	Value	Units
Input voltage	V _{IN}	37 to 57	V
Adapter voltage	V _{ADAPTER}	24	V
Output voltage	V _{OUT}	12	V
Output power	P _{OUT}	11 (1)	W

Notes:

- 1) When using a 24V adapter input, the maximum output current will be below 11W, and is limited by transformer design.

FEATURES

- 36V to 57V POE Input or 24V Auxiliary Adapter Input
- 12V Output Voltage and 11W Output Power
- Primary-Side Regulated Flyback without Optocoupler Feedback
- Compatible with 802.3af Specifications
- Discontinuous Conduction Work Mode
- Integrated 180V Switching Power MOSFET
- Up to 3A Programmable Current Limit
- Includes Overload Protection (OLP), Over-Voltage Protection (OVP), Open-Circuit Protection, and Thermal Protection
- Minimal External Components Count
- Available in a QFN-28 (4mmx5mm) Package

APPLICATIONS

- Security Cameras
- VoIP Phones
- WLAN Access Points
- General Flyback Converters

All MPS parts are lead-free, halogen free, and adhere to the RoHS directive. For MPS green status, please visit the MPS website under Quality Assurance. "MPS", the MPS logo, and "Simple, Easy Solutions" are Registered Trademarks of Monolithic Power Systems, Inc. or its subsidiaries.

EV8007H-V-00A EVALUATION BOARD

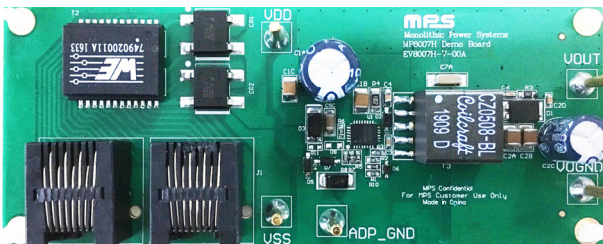

(LxWxH) (11.5cmx4.5cmx1.5cm)

Board Number	MPS IC Number
EV8007H-V-00A	MP8007H

Efficiency vs. Load Current

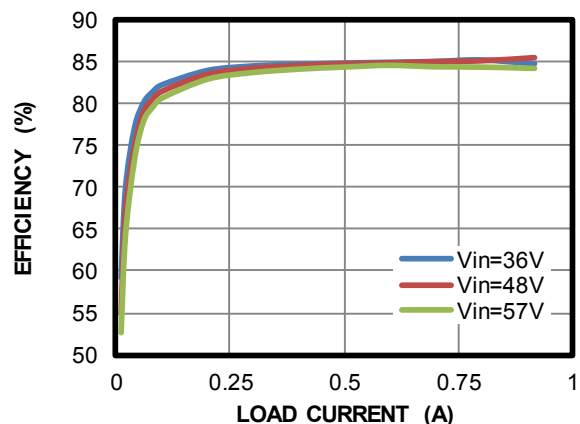

QUICK START GUIDE

The output voltage of this board is set to 12V. The board layout accommodates most commonly used components. There are two methods to start MP8007H.

Method 1:

1. Connect the load terminals to:
 - a. Positive (+): VOUT
 - b. Negative (-): VOGND
2. Plug the cable coming from the PSE into the Ethernet jack (J1). The board should automatically start up.

Method 2:

1. Preset the power supply to $40V \leq V_{IN} \leq 57V$. (It can work in $37V \leq V_{IN} \leq 57V$ after power-up.)
2. Turn the power supply off.
3. Connect the power supply terminals to:
 - a. Positive (+): VDD
 - b. Negative (-): VSS
4. Connect the load terminals to:
 - a. Positive (+): VOUT
 - b. Negative (-): VOGND
5. Turn the power supply on after making the connections.
6. The MP8007H is enabled on the evaluation board once VDD is applied.
7. The MP8007H can supply V_{CC} through the internal high voltage LDO, and D6 and R10 can be removed to save BOM cost, though this may lead to an efficiency decrease of about 0.2%.
8. To use the adapter supply function, connect the adapter positive terminals to:
 - a. Positive (+): VDD
 - b. Negative (-): ADP_GND
9. Turn on the adapter; the board will use the adapter to supply its power.

EVALUATION BOARD SCHEMATIC

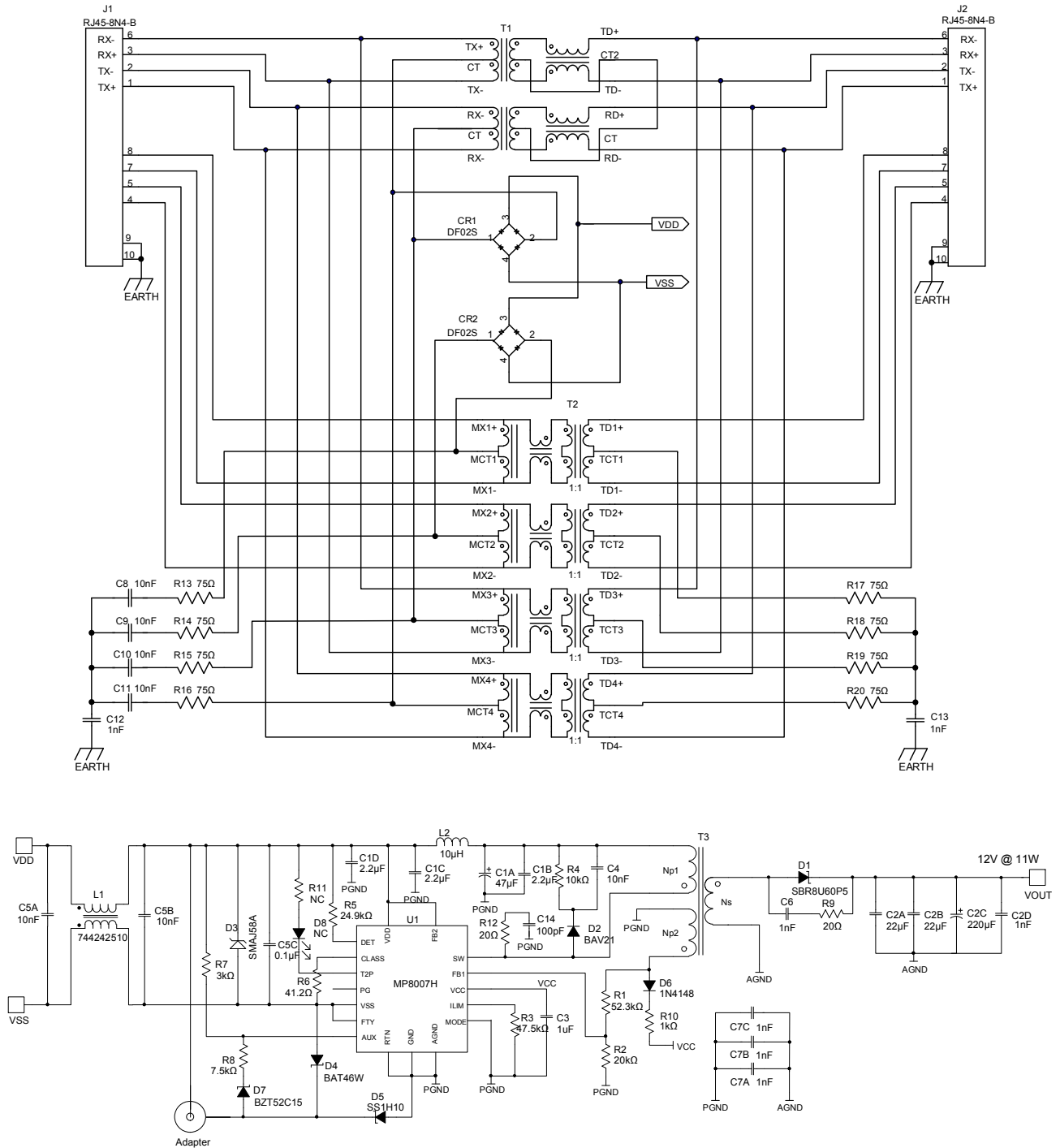

Figure 1: Evaluation Board Schematic

EV8007H-V-00A BILL OF MATERIALS

Qty	Ref	Value	Description	Package	Manufacturer	Manufacturer P/N
1	C1A	47 μ F	47 μ F, 100V, CD284, e-capacitor, 10mmx12.5mm	DIP	Jianghai	ECR2AXY470M100012
3	C1B, C1C, C1D	2.2 μ F	Ceramic capacitor, 100V, X7R	1210	Murata	GRM32ER72A225KA35L
2	C2A, C2B	22 μ F	Ceramic capacitor, 25V, X7R	1210	Murata	GRM32ER71E226KE15L
1	C2C	220 μ F	220 μ F, 25V, CD284, e-capacitor, 8mmx11.5mm	DIP	Jianghai	ECR1EXY221M080011
1	C2D	1nF	Ceramic capacitor, 50V, C0G	0603	Murata	GRM1885C1H102JA01D
1	C3	1 μ F	Ceramic capacitor, 10V, X7R	0603	Murata	GRM188R71A105KA61D
3	C4, C5A, C5B	10nF	Ceramic capacitor, 100V, X7R	0805	Murata	GRM216R72A103KA01D
1	C5C	0.1 μ F	Ceramic capacitor, 100V, X7R	1206	Murata	GRM319R72A104KA01D
1	C6	1nF	Ceramic capacitor, 100V, X7R	0603	Murata	GRM188R72A102KA01D
5	C7A, C7B, C7C, C12, C13	1nF	Ceramic capacitor, 2000V, X7R	1808	Murata	GR442QR73D102KW01L
4	C8, C9, C10, C11	10nF	Ceramic capacitor, 100V, X7R	0603	Murata	GRM188R72A103KA01D
1	C14	100pF	Ceramic capacitor, 250V, X7R	0805	Murata	GRM216R72E101KA01D
1	R1	52.3k Ω	Film resistor, 1%	0603	Royal Ohm	RC0603FR-0752K3L
1	R2	20k Ω	Film resistor, 1%	0603	Royal Ohm	RC0603FR-0720KL
1	R3	47.5k Ω	Film resistor, 1%	0603	Royal Ohm	RC0603FR-0747K5L
1	R4	10k Ω	Film resistor, 1%	1206	Royal Ohm	RC1206FR-0710KL
1	R5	24.9k Ω	Film resistor, 1%	0603	Royal Ohm	RC0603FR-0724K9L
1	R6	41.2 Ω	Film resistor, 1%	0603	Royal Ohm	RC0603FR-0741R2L
1	R7	3k Ω	Film resistor, 1%	0603	Royal Ohm	RC0603FR-073KL
1	R8	7.5k Ω	Film resistor, 5%	0603	Royal Ohm	RC0603JR-077K5L
2	R9,R12	20 Ω	Film resistor, 1%	0805	Royal Ohm	RC0805FR-0720RL
1	R10	1k Ω	Film resistor, 1%	0603	Royal Ohm	RC0603FR-071KL
0	R11	NC				
8	R13, R14, R15, R16, R17, R18, R19, R20	75 Ω	Film resistor, 1%	0603	Royal Ohm	RC0603FR-0775RL
1	D1	SBR8U60 P5	8A, 60V, super barrier rectifier	POWER DI5	Diodes Inc.	SBR8U60P5
1	D2	BAV21	200V, 200mW, switching diode	SOD-123	Diodes Inc.	BAV21W-7-F
1	D3	SMAJ58A	TVS	SMA	Littelfuse	SMAJ58A

EV8007H-V-00A BILL OF MATERIALS (continued)

Qty	Ref	Value	Description	Package	Manufacturer	Manufacturer P/N
1	D4	BAT46W	100V diode	SOD-123	Diodes Inc.	BAT46W-7-F
1	D5	SS1H10	100V Schottky diode	DO-214AC	Vishay	SS1H10-E3/61T
1	D6	1N4148	75V, 250mW switching diode	SOD-323	Diodes Inc.	1N4148WS-7
1	D7	BZT52C15	15V Zener diode	SOD-123	Diodes Inc.	BZT52C15
0	D8	NC				
0	T1	NC				
1	T2	749020011A	WE-LAN LAN transformer	SMD	Würth	749020011A
1	T3	16.4µH	Transformer, $L_P = 16.4\mu\text{H}$, core = EP13	EP13	Coilcraft	CZ0508-BL
2	L1	51µHx2	Common-mode line filter	SMD	Würth	744242510
1	L2	10µH	$I_{SAT} = 4.9\text{A}$, $I_{RMS} = 4.9\text{A}$		Coilcraft	XAL5050-103MEC
2	J1, J2	RJ45-8N4-B	RJ jack	RJ45-TAB	Tyco Electronics	RJ45-8N4-B
2	CR1, CR2	DF02S	1.0A surface-mount glass passivated bridge rectifier	DF-S	Diodes Inc.	DF02S
1	U1	MP8007H	IEEE 802.3af compatible PSR flyback PD device	QFN-28	MPS	MP8007HGV

EVB TEST RESULTS

$V_{IN} = 48V$, $V_{OUT} = 12V$, $P_{OUT} = 11W$, $T_A = 25^\circ C$, unless otherwise noted.

Efficiency vs. Load Current

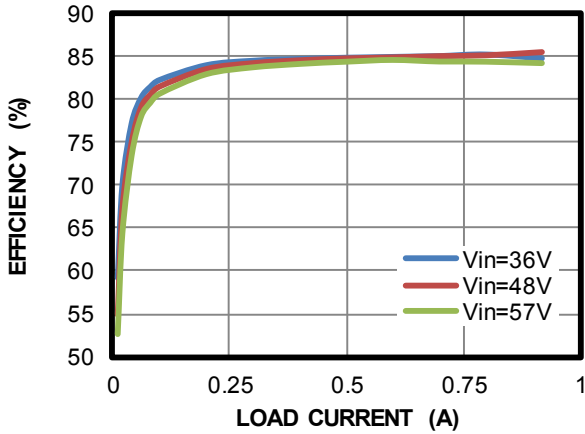

Load Regulation

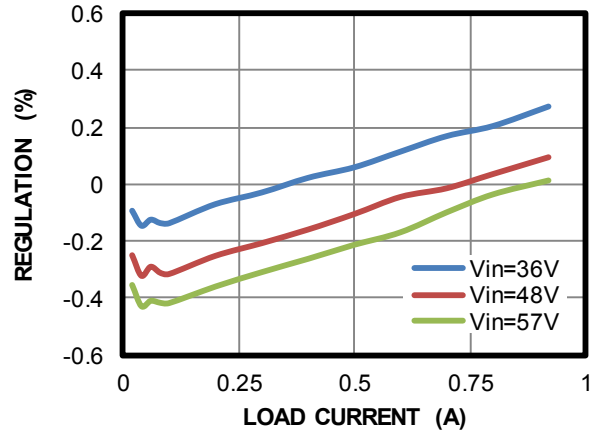

Line Regulation

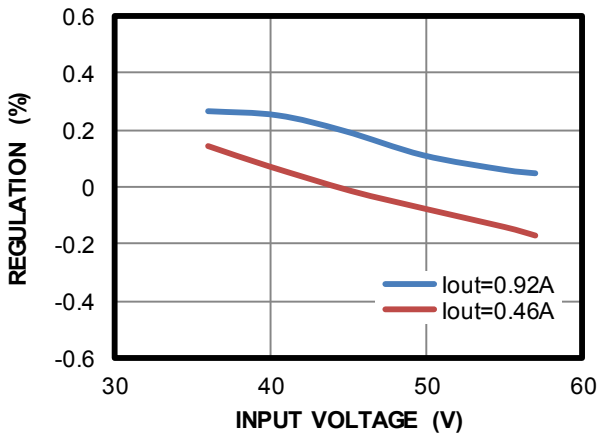

Radiated Emissions Results

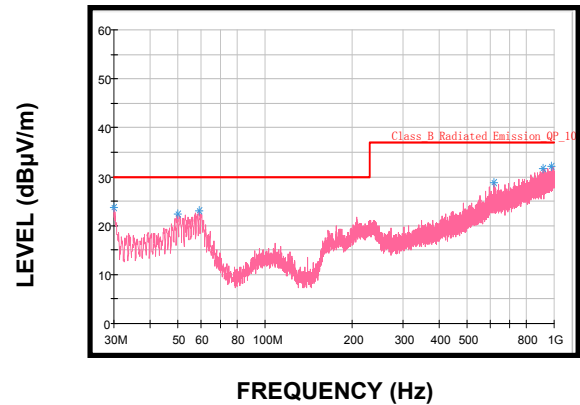

Conducted Emissions Results

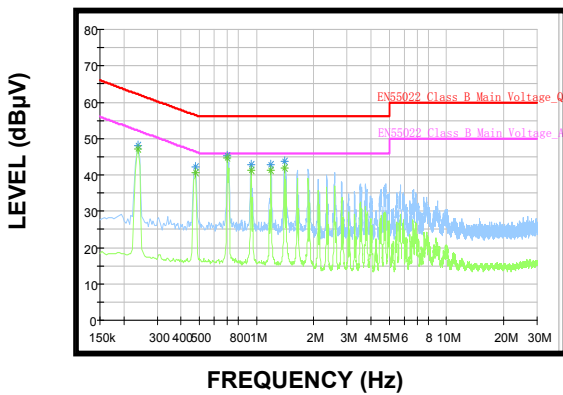

EVB TEST RESULTS (continued)

$V_{IN} = 48V$, $V_{OUT} = 12V$, $P_{OUT} = 11W$, $T_A = 25^\circ C$, unless otherwise noted.

Steady State

$I_{OUT} = 15mA$

CH1: V_{out}/AC
100mV/div.
CH2: V_{in}
20V/div.
CH3: SW
50V/div.
CH3: I_{PRI}
2A/div.

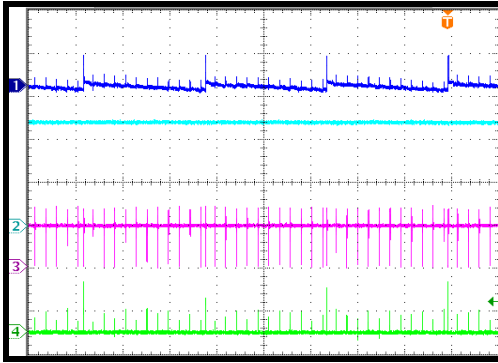

400µs/div.

Steady State

$I_{OUT} = 100mA$

CH1: V_{out}/AC
100mV/div.
CH2: V_{in}
20V/div.
CH3: SW
50V/div.
CH3: I_{PRI}
2A/div.

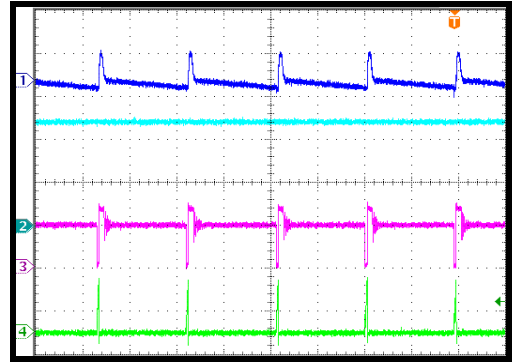

20µs/div.

Steady State

$I_{OUT} = 0.92A$

CH1: V_{out}/AC
100mV/div.
CH2: V_{in}
20V/div.
CH3: SW
50V/div.
CH3: I_{PRI}
2A/div.

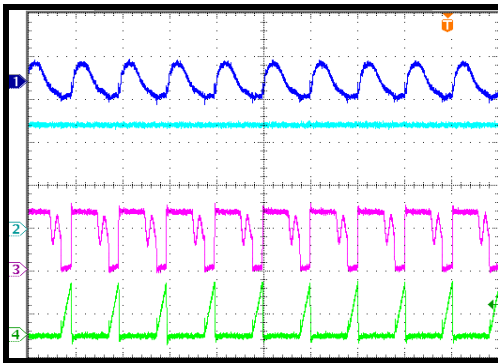

4µs/div.

V_{IN} Start-Up

$I_{OUT} = 15mA$

CH1: V_{out}
5V/div.
CH2: V_{in}
20V/div.
CH3: SW
50V/div.
CH3: I_{PRI}
2A/div.

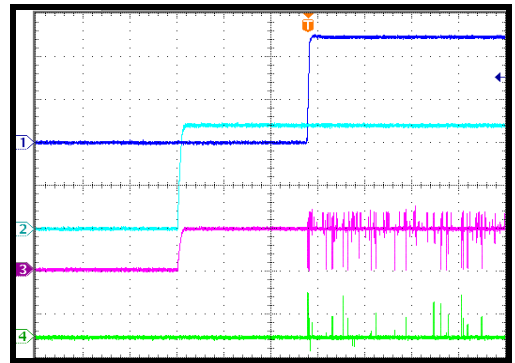

40ms/div.

V_{IN} Start-Up

$I_{OUT} = 0.92A$

CH1: V_{out}
5V/div.
CH2: V_{in}
20V/div.
CH3: SW
50V/div.
CH3: I_{PRI}
2A/div.

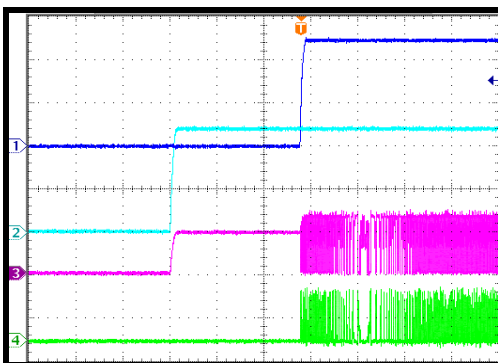

40ms/div.

V_{IN} Shutdown

$I_{OUT} = 15mA$

CH1: V_{out}
5V/div.
CH2: V_{in}
20V/div.
CH3: SW
50V/div.
CH3: I_{PRI}
2A/div.

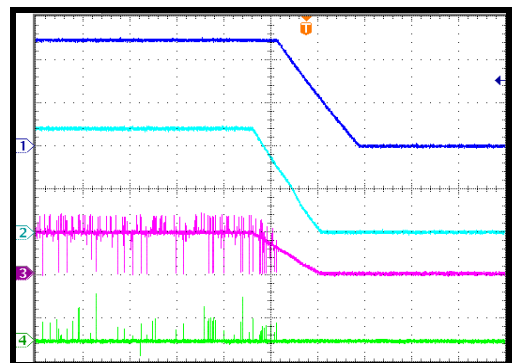

200ms/div.

EVB TEST RESULTS (continued)

$V_{IN} = 48V$, $V_{OUT} = 12V$, $P_{OUT} = 11W$, $T_A = 25^{\circ}C$, unless otherwise noted.

VIN Shutdown

$I_{OUT} = 0.92A$

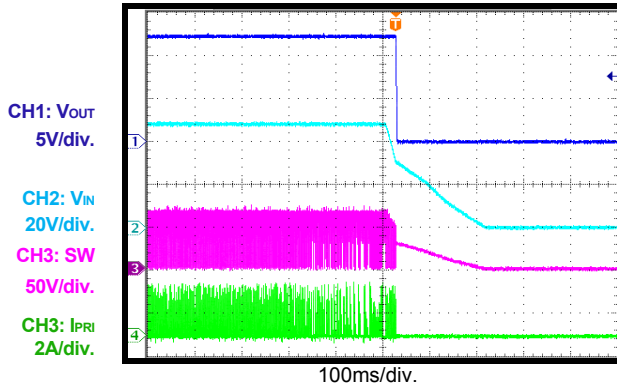

SCP Entry

$I_{OUT} = 15mA$ to short

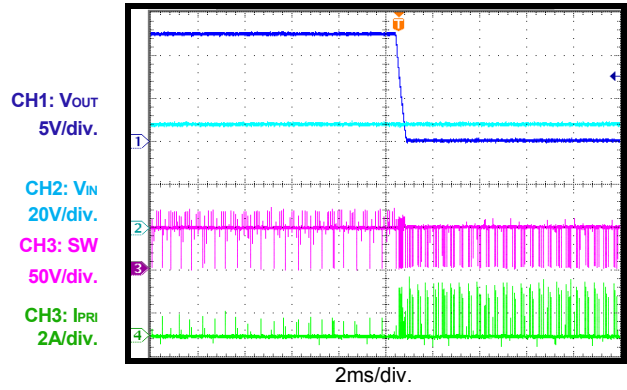

SCP Entry

$I_{OUT} = 0.92A$ to short

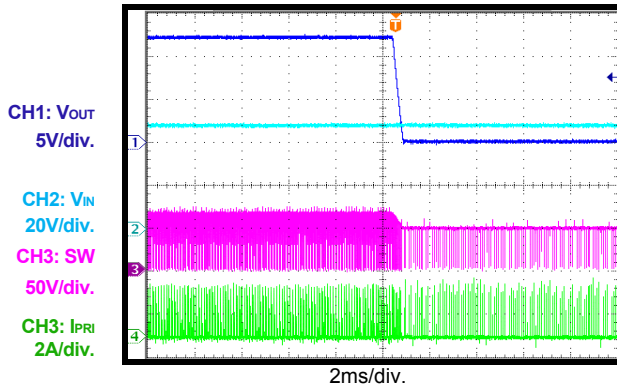

SCP Recovery

$I_{OUT} =$ short to 15mA

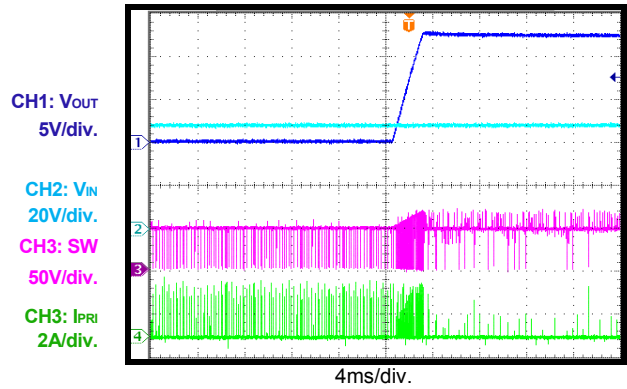

SCP Recovery

$I_{OUT} =$ short to 0.92A

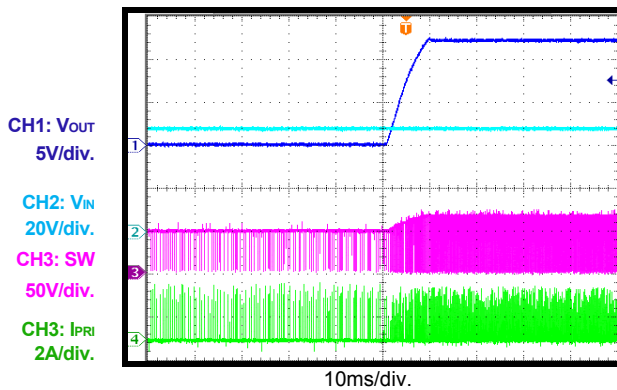

Load Transient

$I_{OUT} = 15mA$ to 0.46A, $I_{RAMP} = 25mA/\mu s$

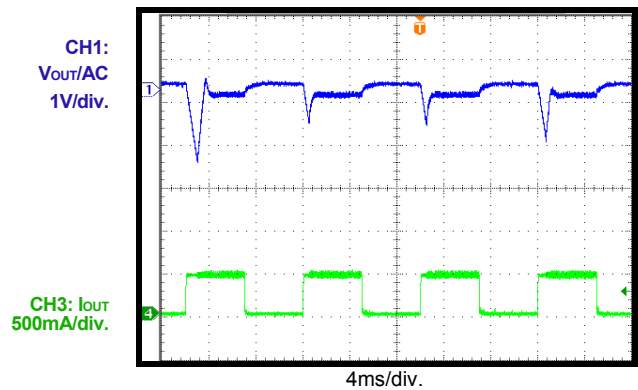

EVB TEST RESULTS (continued)
 $V_{IN} = 48V$, $V_{OUT} = 12V$, $P_{OUT} = 11W$, $T_A = 25^\circ C$, unless otherwise noted.

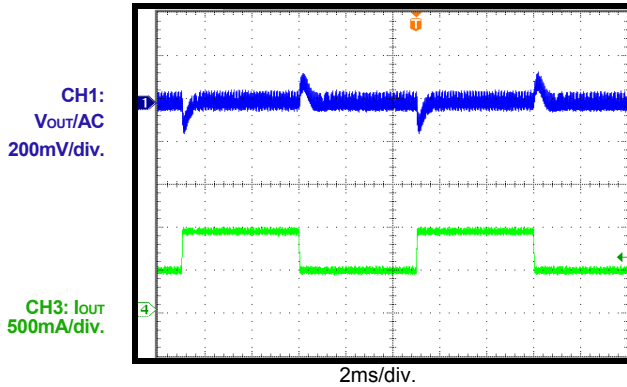
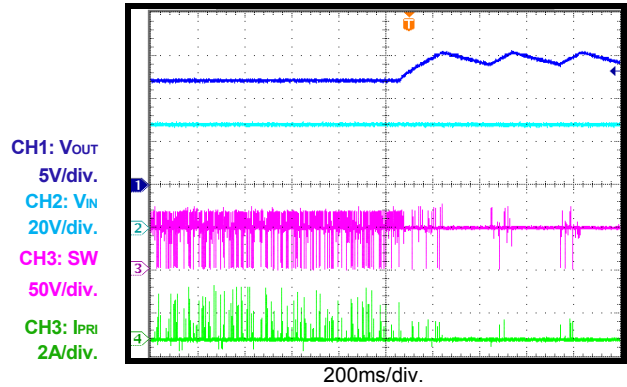
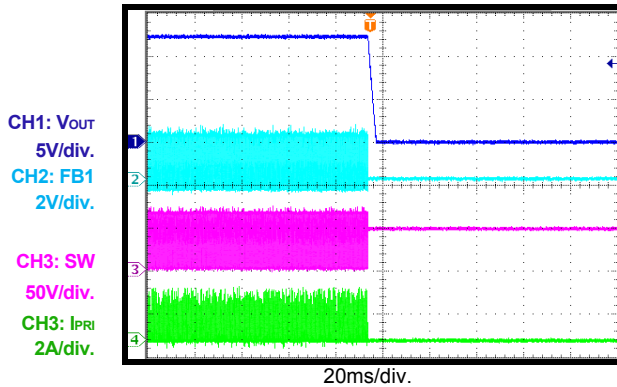
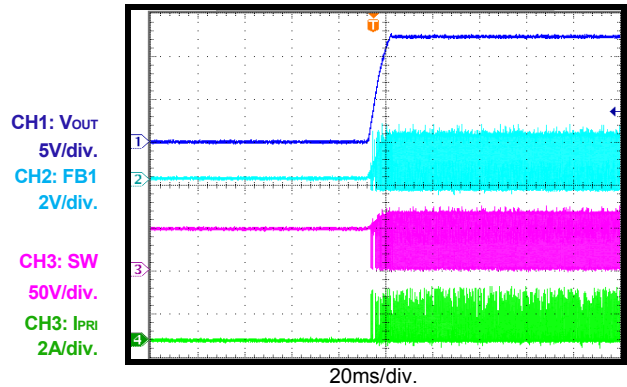
Load Transient
 $I_{OUT} = 0.46A$ to $0.92A$, $I_{RAMP} = 25mA/\mu s$

OVP Entry
 $I_{OUT} = 100mA$ to $2mA$

Open Circuit Entry
 $I_{OUT} = 0.92A$, short FB1 to GND

Open Circuit Recovery
 $I_{OUT} = 0.92A$, release FB1 from short condition

PCB LAYOUT

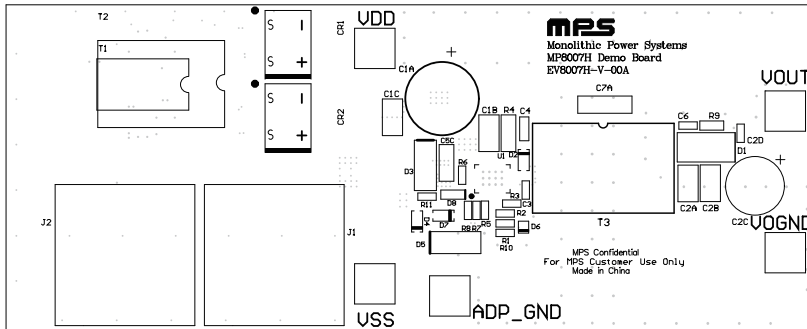

Figure 2: Top Silk Layer

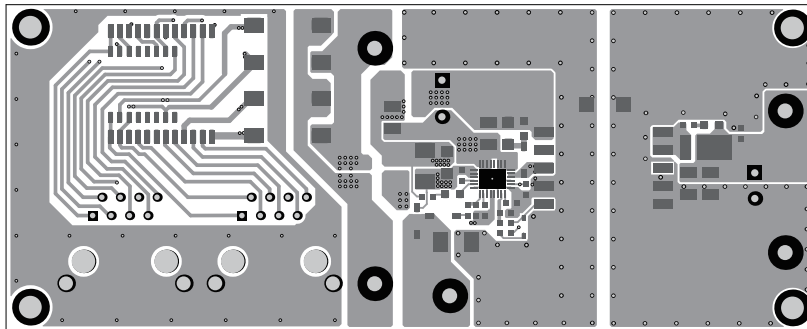

Figure 3: Top Layer

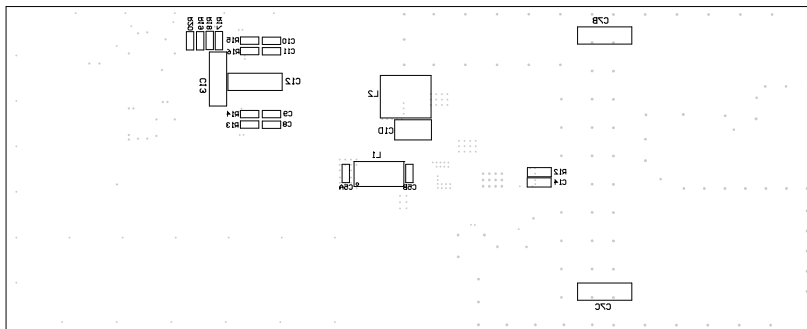

Figure 4: Bottom Silk Layer

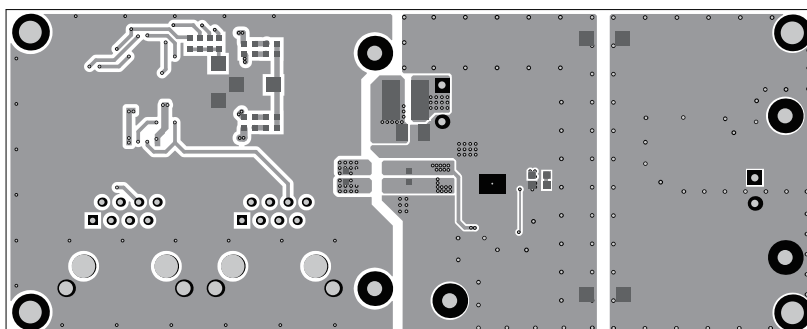

Figure 5: Bottom Layer