

### DESCRIPTION

The EV8771-Q-00A Evaluation Board is designed to demonstrate the capabilities of MPS' MP8771, a fully-integrated high-frequency, synchronous rectified, step-down, switch-mode converter with internal power MOSFETs. It offers a very compact solution to achieve a 10A continuous output current over a wide input range, with excellent load and line regulation. The MP8771 has synchronous-mode operation for higher efficiency over the output current-load range.

Constant On-Time control operation provides very fast transient response and easy loop design as well as very tight output regulation.

Full protection features include SCP, OCP, UVP, and thermal shutdown.

The MP8771 requires a minimal number of readily-available, standard, external components and is available in a space-saving QFN-16 (3mmx3mm) package.

### ELECTRICAL SPECIFICATION <sup>(1)</sup>

Parameter	Symbol	Value	Units
Input Voltage	V <sub>IN</sub>	12	V
Output Voltage	V <sub>OUT</sub>	1	V
Output Current	I <sub>OUT</sub>	10	A

### FEATURES

- Wide 4.5V-to-17V Operating Input Range
- 17mΩ/8mΩ Low-R<sub>DS(ON)</sub> Internal Power MOSFETs
- 100μA Low IQ Current
- High-Efficiency Synchronous-Mode Operation
- Pre-biased Startup
- Fixed 700kHz Switching Frequency
- External Programmable Soft Startup Time
- EN and Power Good for Power Sequencing
- Over-Current Protection and Hiccup
- Thermal Shutdown
- Output Adjustable from 0.6V
- Available in a QFN-16 (3mmx3mm) package

### APPLICATIONS

- Security Camera
- Portable Device, XDSL Device
- Digital Set-Top Boxes
- Flat-Panel Television and Monitors
- General Purposes

**Notes:**

1) For different Input/output voltage specs and different output capacitor/inductor may need change the application circuit parameters

All MPS parts are lead-free, halogen free, and adhere to the RoHS directive. For MPS green status, please visit MPS website under Quality Assurance.

"MPS" and "The Future of Analog IC Technology" are Registered Trademarks of Monolithic Power Systems, Inc.

## EV8771-Q-00A EVALUATION BOARD

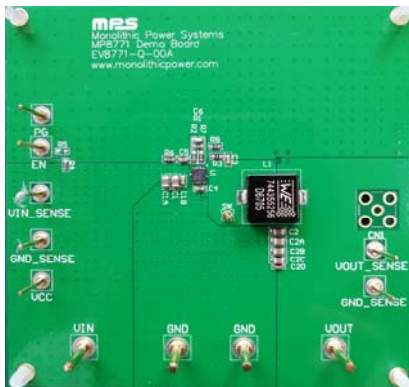

(L x W) 85mm x 85mm

Board Number	MPS IC Number
EV8771-Q-00A	MP8771GQ

### Efficiency vs. Load Current

V<sub>OUT</sub>=1V, L=0.56μH, DCR=1.5mΩ

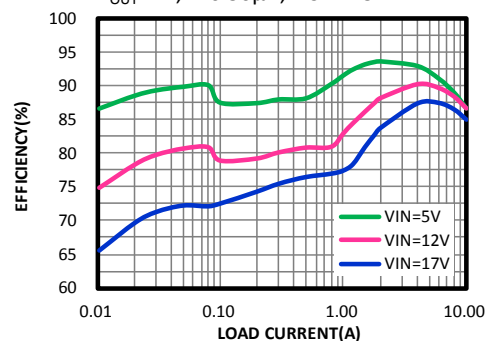

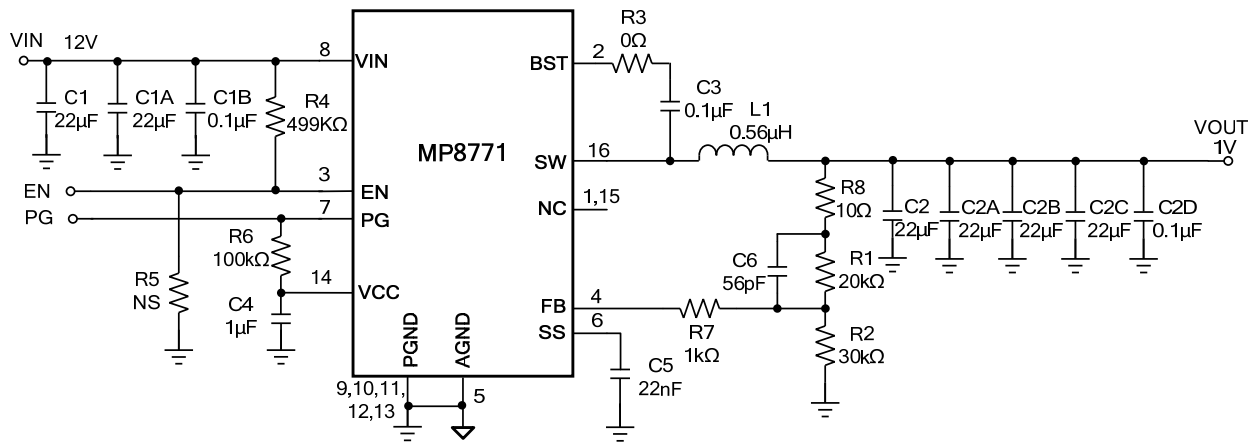
**EVALUATION BOARD SCHEMATIC**

**EV8771-Q-00A BILL OF MATERIALS**

Qty	Ref	Value	Description	Package	Manufacturer	Part Number
6	C1,C1A, C2,C2A, C2B,C2C	22μF	Ceramic Cap., 25V, X5R	0805	muRata	GRM21BR61E226ME44L
3	C1B,C2D C3	0.1μF	Ceramic Cap., 25V, X7R	0603	muRata	GRM188R71E104KA01D
1	C4	1μF	Ceramic Cap., 25V, X7R	0603	muRata	GRM188R71E105KA12D
1	C5	22nF	Ceramic Cap., 16V, X7R	0603	muRata	GRM188R71C223KA01D
1	C6	56pF	Ceramic Cap., 50V, C0G	0603	muRata	GRM1885C1H560JA01D
1	R1	20k	Thick Film Res., 1%	0603	Yageo	RC0603FR-0720KL
1	R2	30k	Thick Film Res., 1%	0603	Yageo	RC0603FR-0730KL
1	R3	0Ω	Thick Film Res., 1%	0603	Yageo	RC0603FR-070RL
1	R4	499k	Thick Film Res., 1%	0603	Yageo	RC0603FR-07499KL
0	R5,R9, R10	NS		0603		
1	R6	100k	Thick Film Res., 1%	0603	Yageo	RC0603FR-07100KL
1	R7	1k	Thick Film Res., 1%	0603	Yageo	RC0603FR-071KL
1	R8	10Ω	Thick Film Res., 1%	0603	Yageo	RC0603JR-0710RL
1	L1	0.56μH	Inductor, DCR=1.5mΩ,Is=30A	SMD	Wurth	744355256
1	U1	MP8771	Synchronous Step-Down Convert	QFN-16 (3mmx3mm)	MPS	MP8771GQ

## EVB TEST RESULTS

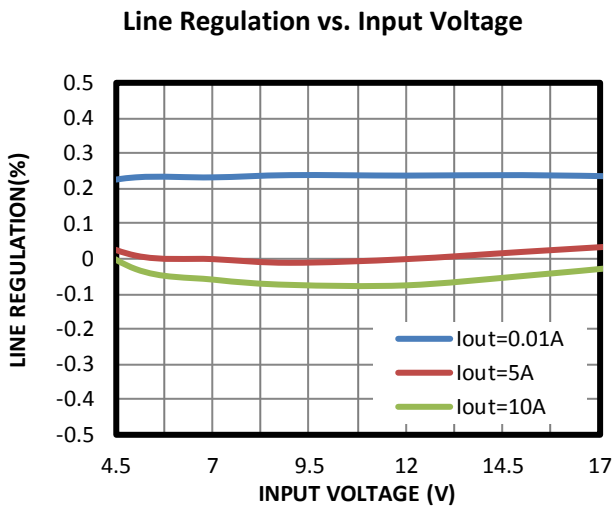
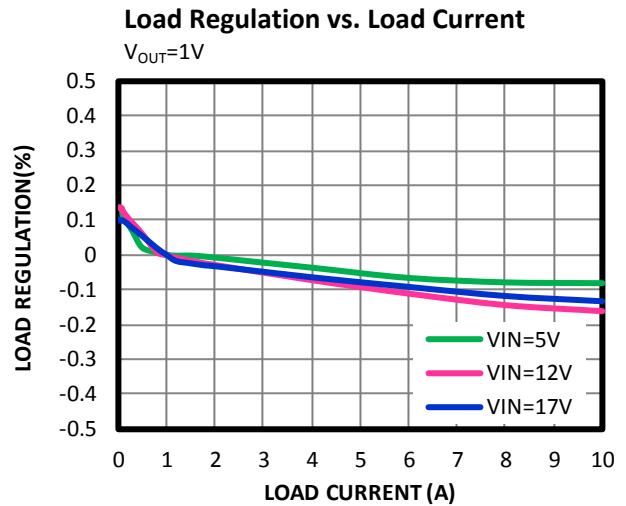
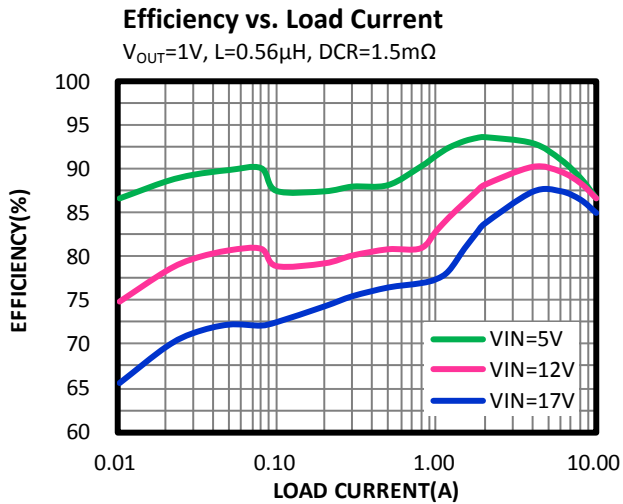
$V_{IN} = 12V$ ,  $V_{OUT} = 1V$ ,  $L = 0.56\mu H$ ,  $T_A = +25^\circ C$ , unless otherwise noted.



**EVB TEST RESULTS** *(continued)*

$V_{IN} = 12V$ ,  $V_{OUT} = 1V$ ,  $L = 0.56\mu H$ ,  $T_A = +25^\circ C$ , unless otherwise noted.

**Input/Output Ripple**

$I_{OUT}=0A$

CH1:  $V_{OUT}/AC$   
50mV/div.  
CH2:  $V_{IN}/AC$   
50mV/div.  
CH3:  $V_{SW}$   
5V/div.  
CH4:  $I_L$   
2A/div.

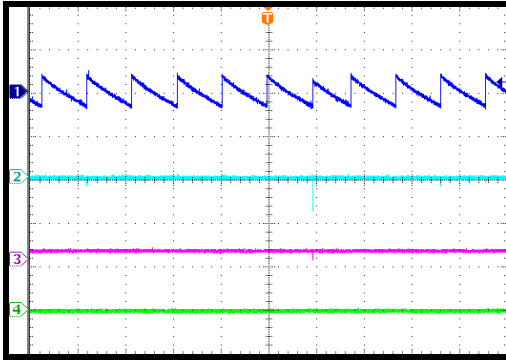

100ms/div.

**Input/Output Ripple**

$I_{OUT}=0A$

CH1:  $V_{OUT}/AC$   
50mV/div.  
CH2:  $V_{IN}/AC$   
100mV/div.  
CH3:  $V_{SW}$   
10V/div.  
CH4:  $I_L$   
5A/div.

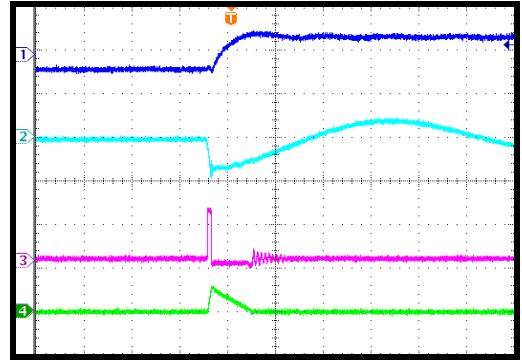

2µs/div.

**Input/Output Ripple**

$I_{OUT}=10A$

CH1:  $V_{OUT}/AC$   
10mV/div.  
CH2:  $V_{IN}/AC$   
500mV/div.  
CH3:  $V_{SW}$   
10V/div.  
CH4:  $I_L$   
10A/div.

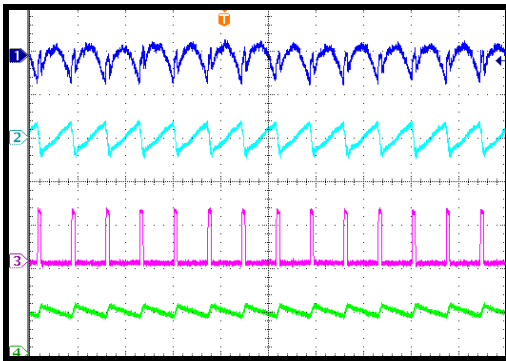

2µs/div.

**Start-Up through Input Voltage**

$I_{OUT}=0A$

CH1:  $V_{OUT}$   
1V/div.  
CHR1:  $V_{PG}$   
5V/div.  
CH2:  $V_{IN}$   
10V/div.  
CH3:  $V_{SW}$   
10V/div.  
CH4:  $I_L$   
10A/div.

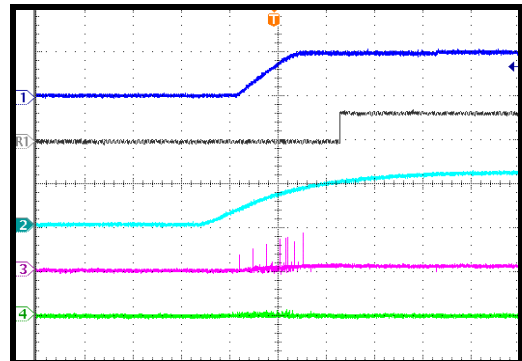

2ms/div.

**Start-Up through Input Voltage**

$I_{OUT}=10A$

CH1:  $V_{OUT}$   
1V/div.  
CHR1:  $V_{PG}$   
5V/div.  
CH2:  $V_{IN}$   
10V/div.  
CH3:  $V_{SW}$   
10V/div.  
CH4:  $I_L$   
10A/div.

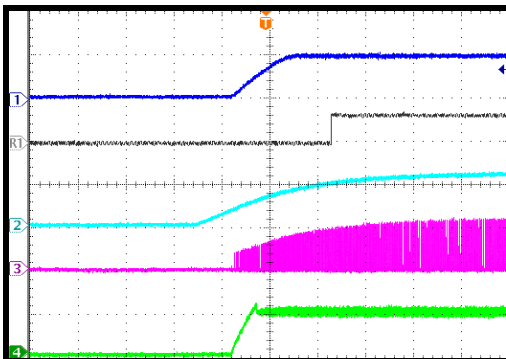

2ms/div.

**Shutdown through Input Voltage**

$I_{OUT}=0A$

CH1:  $V_{OUT}$   
1V/div.  
CHR1:  $V_{PG}$   
5V/div.  
CH2:  $V_{IN}$   
10V/div.  
CH3:  $V_{SW}$   
10V/div.  
CH4:  $I_L$   
10A/div.

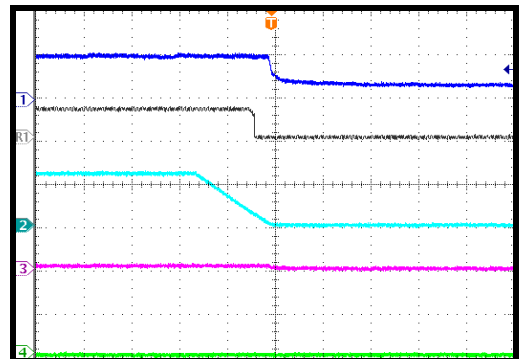

40ms/div.

**EVB TEST RESULTS** *(continued)*

$V_{IN} = 12V$ ,  $V_{OUT} = 1V$ ,  $L = 0.56\mu H$ ,  $T_A = +25^\circ C$ , unless otherwise noted.

**Shutdown through Input Voltage**

$I_{OUT} = 10A$

CH1:  $V_{OUT}$   
1V/div.  
CHR1:  $V_{PG}$   
5V/div.  
CH2:  $V_{IN}$   
10V/div.  
CH3:  $V_{SW}$   
10V/div.  
CH4:  $I_L$   
10A/div.

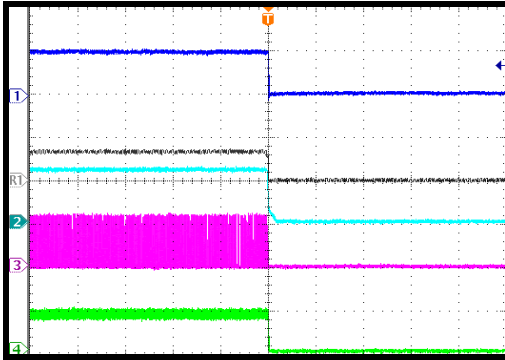

100ms/div.

**Start-Up through EN**

$I_{OUT} = 0A$

CH1:  $V_{OUT}$   
1V/div.  
CHR1:  $V_{PG}$   
5V/div.  
CH2:  $V_{EN}$   
5V/div.  
CH3:  $V_{SW}$   
10V/div.  
CH4:  $I_L$   
10A/div.

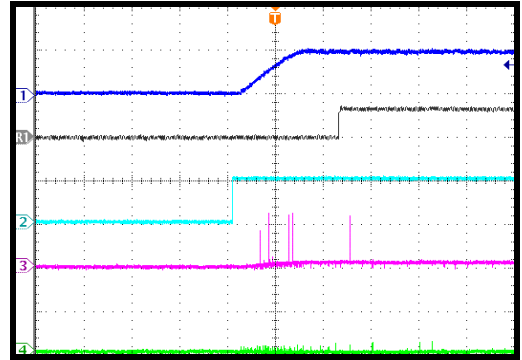

2ms/div.

**Start-Up through EN**

$I_{OUT} = 10A$

CH1:  $V_{OUT}$   
1V/div.  
CHR1:  $V_{PG}$   
5V/div.  
CH2:  $V_{EN}$   
5V/div.  
CH3:  $V_{SW}$   
10V/div.  
CH4:  $I_L$   
10A/div.

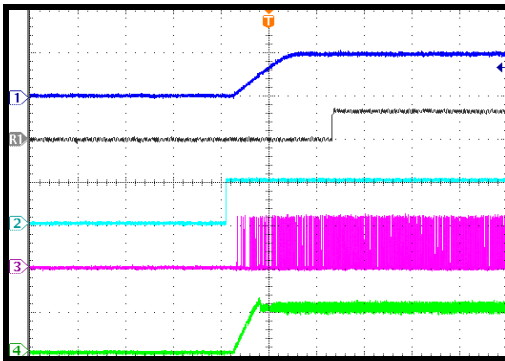

2ms/div.

**Shutdown through EN**

$I_{OUT} = 0A$

CH1:  $V_{OUT}$   
1V/div.  
CHR1:  $V_{PG}$   
5V/div.  
CH2:  $V_{EN}$   
5V/div.  
CH3:  $V_{SW}$   
10V/div.  
CH4:  $I_L$   
10A/div.

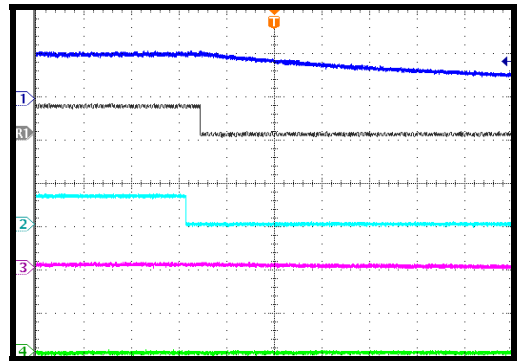

400ms/div.

**Shutdown through EN**

$I_{OUT} = 10A$

CH1:  $V_{OUT}$   
1V/div.  
CHR1:  $V_{PG}$   
5V/div.  
CH2:  $V_{EN}$   
5V/div.  
CH3:  $V_{SW}$   
10V/div.  
CH4:  $I_L$   
10A/div.

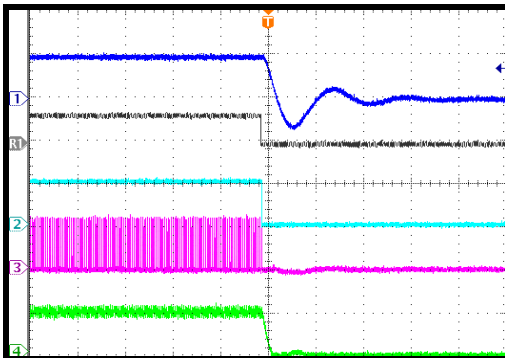

40µs/div.

**Short Circuit Protection Entry**

$I_{OUT} = 0A$

CH1:  $V_{OUT}$   
1V/div.  
CH2:  $V_{PG}$   
5V/div.  
CH3:  $V_{SW}$   
10V/div.  
CH4:  $I_L$   
10A/div.

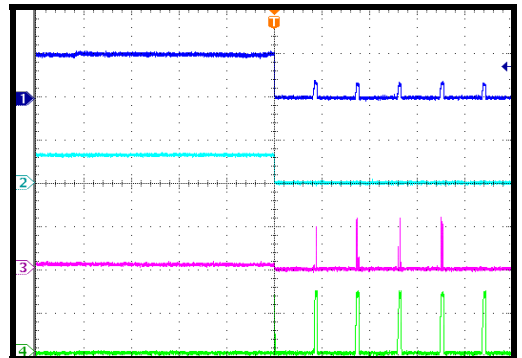

20ms/div.

**EVB TEST RESULTS** *(continued)*

$V_{IN} = 12V$ ,  $V_{OUT} = 1V$ ,  $L = 0.56\mu H$ ,  $T_A = +25^\circ C$ , unless otherwise noted.

**Short Circuit Protection Steady State**  
Short Output to GND

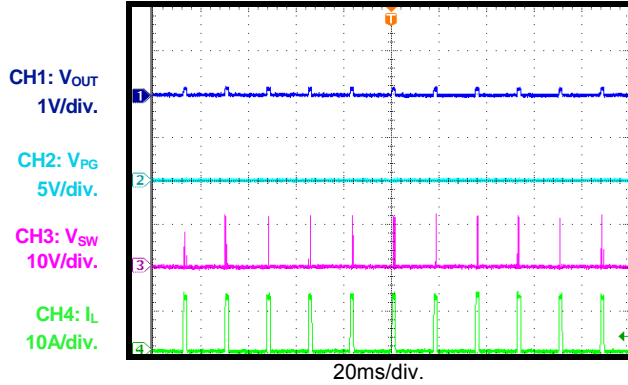

**Short Circuit Protection Recovery**  
 $I_{OUT}=0A$

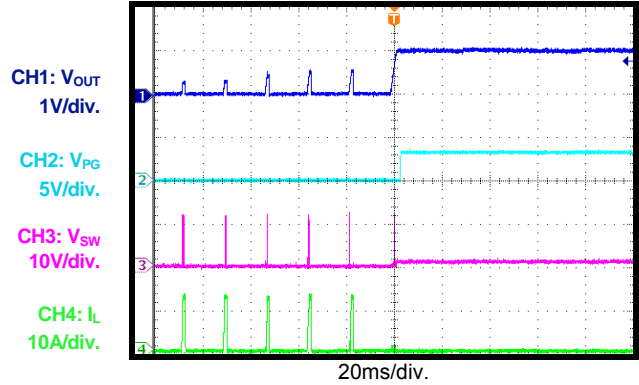

**Load Transient**

$I_{OUT}=5A-10A$

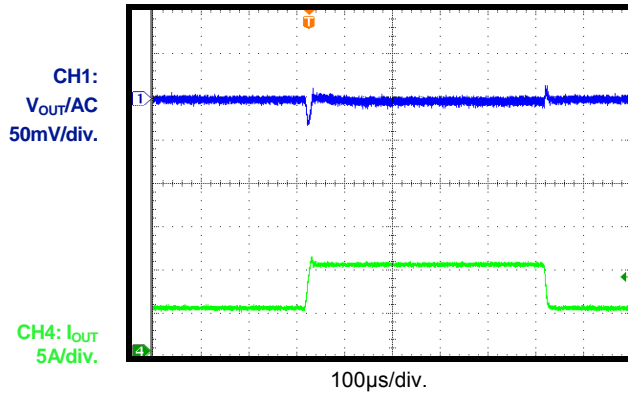

## PRINTED CIRCUIT BOARD LAYOUT

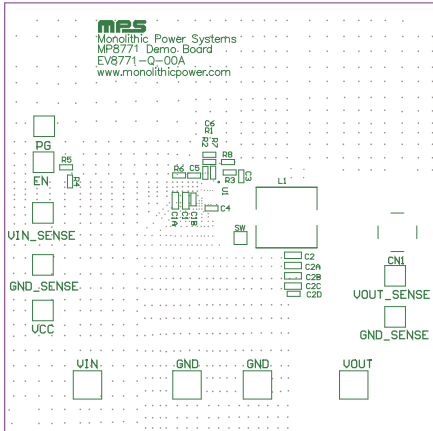

Figure 1—Top Silk Layer

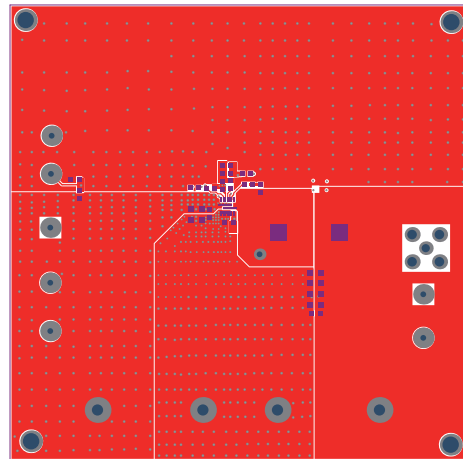

Figure 2—Top Layer

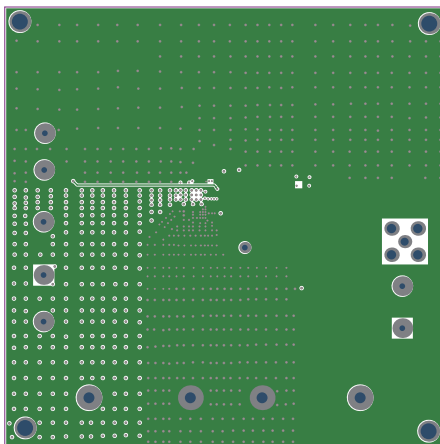

Figure 3—Inner Layer 1

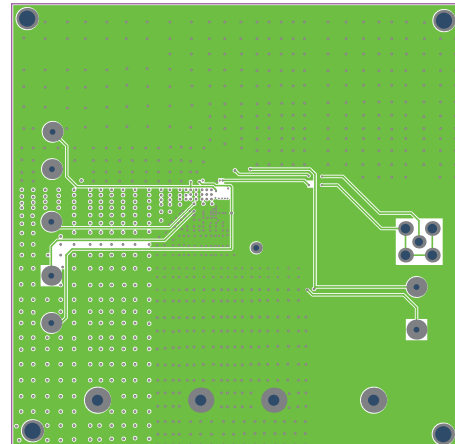

Figure 4—Inner Layer 2

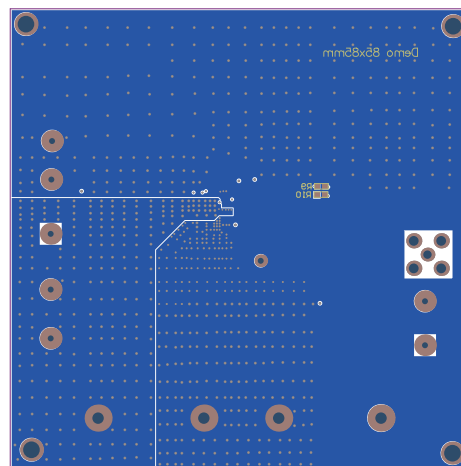

Figure 5—Bottom Layer