

FEATURES

- ▶ High performance
 - ▶ Throughput: 2 MSPS (AD4030-24) or 500 kSPS (AD4032-24) options
 - ▶ INL: ± 0.9 ppm maximum from -40°C to $+125^{\circ}\text{C}$
 - ▶ SNR: 108.4 dB typical
 - ▶ THD: -127 dB typical
 - ▶ NSD: -169 dBFS/Hz typical
- ▶ Low power
 - ▶ 30 mW at 2 MSPS
 - ▶ 10 mW at 500 kSPS
 - ▶ 3 mW at 10 kSPS
- ▶ Easy Drive™ features reduce system complexity
 - ▶ Low 1.2 μA input current for dc inputs at 2 MSPS
 - ▶ Wide common-mode input range: $-(1/128) \times V_{\text{REF}}$ to $+(129/128) \times V_{\text{REF}}$
- ▶ Flexible external reference voltage range: 4.096 V to 5 V
 - ▶ Accurate integrated reference buffer with 2 μF bypass capacitor
- ▶ Programmable block averaging filter with up to 2^{16} decimation
 - ▶ Extended sample resolution to 30 bits
 - ▶ Overage and synchronization bits
- ▶ Flexi-SPI digital interface
 - ▶ 1, 2, or 4 SDO lanes allows slower SCK
 - ▶ Echo clock mode simplifies use of digital isolator
 - ▶ Compatible with 1.2 V to 1.8 V logic
- ▶ 7 mm \times 7 mm, 64-Ball CSP_BGA package with internal supply and reference capacitors to help reduce system footprint

APPLICATIONS

- ▶ Automatic test equipment
- ▶ Digital control loops
- ▶ Medical instrumentation
- ▶ Seismology
- ▶ Semiconductor manufacturing
- ▶ Scientific instrumentation

FUNCTIONAL BLOCK DIAGRAM

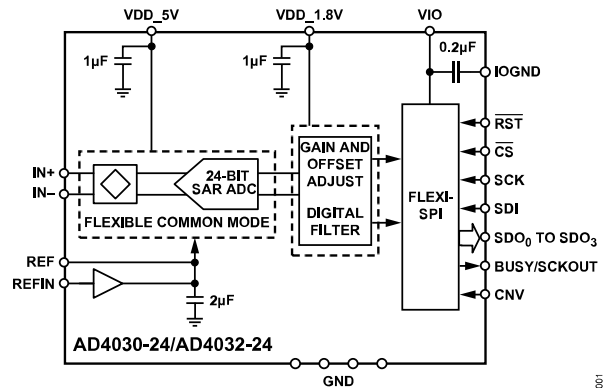

Figure 1. Functional Block Diagram

GENERAL DESCRIPTION

The AD4030-24/AD4032-24 are 2 MSPS or 500 kSPS successive approximation register (SAR), analog-to-digital converters (ADC) with Easy Drive™. With a guaranteed maximum ± 0.9 ppm integral nonlinearity (INL) and no missing codes at 24-bits, the AD4030-24/AD4032-24 achieve unparalleled precision from -40°C to $+125^{\circ}\text{C}$. Figure 1 shows the functional architecture of the AD4030-24/AD4032-24.

A low drift, internal precision reference buffer eases voltage reference sharing with other system circuitry. The AD4030-24/AD4032-24 offer a typical dynamic range of 109 dB when using a 5 V reference. The low noise floor enables signal chains requiring less gain and lower power. A block averaging filter with programmable decimation ratio can increase dynamic range up to 155.5 dB. The wide differential input and common mode ranges allow inputs to use the full $\pm V_{\text{REF}}$ range without saturating, simplifying signal conditioning requirements and system calibration. The improved settling of the Easy Drive analog inputs broadens the selection of analog front-end components compatible with the AD4030-24/AD4032-24. Both single-ended and differential signals are supported.

The versatile Flexi-SPI serial peripheral interface (SPI) eases host processor and ADC integration. A wide data clocking window, multiple SDO lanes, and optional dual data rate (DDR) data clocking can reduce the serial clock to 10 MHz while operating at a sample rate of 2 MSPS or 500 kSPS. Echo clock mode and ADC host clock mode relax the timing requirements and simplify the use of digital isolators.

The 7 mm \times 7 mm, 64-Ball CSP_BGA package of the AD4030-24/AD4032-24 integrates all critical power supply and reference bypass capacitors, reducing the footprint and system component count, and lessening sensitivity to board layout.

TABLE OF CONTENTS

Features.....	1	Device Reset.....	27
Applications.....	1	Power Supplies.....	27
Functional Block Diagram.....	1	Serial Interface.....	29
General Description.....	1	SPI Signals.....	29
Specifications.....	4	Sample Conversion Timing and Data	
Timing Specifications.....	6	Transfer.....	31
Absolute Maximum Ratings.....	12	Clocking Modes	32
Thermal Resistance.....	12	Data Clocking Requirements and Timing.....	35
Electrostatic Discharge (ESD) Ratings.....	12	Layout Guidelines.....	39
ESD Caution.....	12	Registers.....	40
Pin Configuration and Function Descriptions.....	13	Register Details.....	41
Typical Performance Characteristics.....	15	Interface Configuration A Register.....	41
Terminology.....	20	Interface Configuration B Register.....	41
Integral Nonlinearity Error (INL).....	20	Device Configuration Register.....	42
Differential Nonlinearity Error (DNL).....	20	Chip Type Register.....	42
Zero Error (ZE).....	20	Product ID Low Register.....	42
Gain Error (GE).....	20	Product ID High Register.....	42
Spurious-Free Dynamic Range (SFDR).....	20	Chip Grade Register.....	43
Effective Number of Bits (ENOB).....	20	Scratch Pad Register.....	43
Total Harmonic Distortion (THD).....	20	SPI Revision Register.....	43
Dynamic Range (DR).....	20	Vendor ID Low Register.....	44
Signal-to-Noise Ratio (SNR).....	20	Vendor ID High Register.....	44
Signal-to-Noise-and-Distortion (SINAD)		Stream Mode Register.....	44
Ratio.....	20	Interface Status A Register.....	44
Aperture Delay.....	20	Exit Configuration Mode Register.....	45
Transient Response.....	20	Averaging Mode Register.....	45
Common-Mode Rejection Ratio (CMRR).....	20	Offset Registers.....	46
Power Supply Rejection Ratio (PSRR).....	20	Gain Registers.....	46
Theory of Operation.....	21	Modes Register.....	47
Overview.....	21	Internal Oscillator Register.....	47
Converter Operation.....	21	Output Driver Register.....	48
Transfer Function.....	22	Test Pattern Registers.....	48
Analog Features.....	22	Digital Diagnostics Register.....	49
Digital Sample Processing Features.....	22	Digital Errors Register.....	49
Applications Information.....	25	Outline Dimensions.....	50
Typical Application Diagrams.....	25	Ordering Guide.....	50
Analog Front-End Design.....	25	Evaluation Boards.....	50
Reference Circuitry Design	25		

REVISION HISTORY

8/2022—Rev. 0 to Rev. A

Added AD4032-24.....	1
Changes to Features Section, Figure 1, and General Description Section.....	1
Changes to Table 1.....	4
Changes to Table 2.....	6
Change to Table 9.....	12
Changes to Figure 11.....	13
Changes to Figure 25 Caption.....	17

TABLE OF CONTENTS

Added Figure 26; Renumbered Sequentially.....	17
Changes to Figure 30 Caption and Figure 35.....	18
Added Figure 31.....	18
Added Figure 36.....	19
Changes to Overview Section.....	21
Changes to Figure 44 and Figure 45.....	25
Changes to Figure 46 and Reference Circuitry Design Section.....	26
Changes to Figure 50.....	29
Changes to Figure 54 and Figure 55.....	33
Changes to Table 23.....	43
Changes to Table 28.....	44
Changes to Table 29.....	45
Changes to Table 38.....	48
Updated Outline Dimensions.....	50
Changes to Ordering Guide.....	50

4/2022—Revision 0: Initial Version

SPECIFICATIONS

VDD_5V = 5.4 V, VDD_1.8V = 1.8 V, VIO = 1.8 V, REFIN = 5 V, input common mode = 2.5 V, $f_S = 2$ MSPS for the AD4030-24 or 500 kSPS for the AD4032-24, and all specifications T_{MIN} to T_{MAX}, unless otherwise noted. Typical values are at T_A = 25°C.

Table 1.

Parameter	Test Conditions/Comments	Min	Typ	Max	Unit
RESOLUTION		24			Bits
ANALOG INPUT					
Voltage Range	$V_{IN+} - V_{IN-}$	$-(65/64) \times V_{REF}$		$+(65/64) \times V_{REF}$	V
Absolute Input Voltage	V_{IN+}, V_{IN-} to GND	$-(1/128) \times V_{REF}$		$+(129/128) \times V_{REF}$	V
Common-Mode Input Range	$(V_{IN+} + V_{IN-})/2$	$-(1/128) \times V_{REF}$		$+(129/128) \times V_{REF}$	V
Common-Mode Rejection Ratio (CMRR)	$f_{IN} = 10$ kHz		132		dB
Analog Input Current	Acquisition phase, T = 25°C		0.8		nA
	Converting any dc input at 2 MSPS		1.2		μA
Analog Input Capacitance	Acquisition phase		120		pF
	Outside acquisition phase (C _{PIN})		4		pF
THROUGHPUT					
Complete Cycle					
AD4030-24		500			ns
AD4032-24		2000			ns
Conversion Time		264	282	300	ns
Acquisition Phase ¹					
AD4030-24		244	260	275	ns
AD4032-24		1744	1760	1775	ns
Throughput Rate					
AD4030-24		0		2	MSPS
AD4032-24		0		500	kSPS
DC ACCURACY					
No Missing Codes		24			Bits
Integral Nonlinearity Error (INL)		-0.9	±0.1	+0.9	ppm
Differential Nonlinearity Error (DNL)			±0.5		LSB
Transition Noise			21		LSB rms
Zero Error		-90	0	+90	μV
Zero Error Drift			±0.007		ppm/°C
Gain Error	Buffer disabled, REF = 5 V	-0.004	±0.0002	+0.004	%FS
	Buffer enabled, REFIN = 5 V	-0.008	±0.0006	+0.008	%FS
Gain Error Temperature Drift	Buffer disabled, REF = 5 V		±0.025		ppm/°C
	Buffer enabled, REFIN = 5 V		±0.07		ppm/°C
Power Supply Sensitivity	VDD_5V = 5.4 V ± 0.1 V		±0.1		ppm
	VDD_1.8V = 1.8 V ± 5%		±0.2		ppm
Low Frequency Noise ²	Bandwidth = 0.1 Hz to 10 Hz		1.3		μV p-p
AC ACCURACY					
Dynamic Range			109		dB
Noise Spectral Density (NSD)			-169		dBFS/Hz
Total RMS Noise			12.5		μV rms
Signal-to-Noise Ratio (SNR)	$f_{IN} = 1$ kHz, -0.5 dBFS	105.6	108.4		dB
Spurious-Free Dynamic Range (SFDR)	$f_{IN} = 1$ kHz, -0.5 dBFS		127		dB
Total Harmonic Distortion (THD)	$f_{IN} = 1$ kHz, -0.5 dBFS		-127	-115	dB
Signal-to-Noise-and-Distortion (SINAD) Ratio	$f_{IN} = 1$ kHz, -0.5 dBFS	105.6	108.3		dB
Oversampled Dynamic Range	Averaging = 2		112		dB
	Averaging = 256		133		dB
	Averaging = 65536		155.5		dB

SPECIFICATIONS

Table 1.

Parameter	Test Conditions/Comments	Min	Typ	Max	Unit
SNR	VDD_5V = 5.0 V, f _{IN} = 1 kHz, -0.5 dBFS, REFIN = 4.096 V		106.7		dB
SFDR	VDD_5V = 5.0 V, f _{IN} = 1 kHz, -0.5 dBFS, REFIN = 4.096 V		130		dB
THD	VDD_5V = 5.0 V, f _{IN} = 1 kHz, -0.5 dBFS, REFIN = 4.096 V		-130		dB
SINAD	VDD_5V = 5.0 V, f _{IN} = 1 kHz, -0.5 dBFS, REFIN = 4.096 V		106.7		dB
SNR	f _{IN} = 100 kHz, -0.5 dBFS		108.1		dB
THD	f _{IN} = 100 kHz, -0.5 dBFS		-113		dB
SINAD	f _{IN} = 100 kHz, -0.5 dBFS		106.9		dB
-3 dB Input Bandwidth			74		MHz
Aperture Delay			0.7		ns
Aperture Jitter			1.4		ps rms
INTERNAL REFERENCE BUFFER					
REFIN Voltage Range	External reference drives REFIN 5.3 V ≤ VDD_5V ≤ 5.5 V 4.8 V ≤ VDD_5V ≤ 5.25 V 4.75 V ≤ VDD_5V ≤ 5.25 V	4.95	5 4.5 4.096	5.05 4.146	V V V
REFIN Bias Current		-50	5	+50	nA
REFIN Input Capacitance			40		pF
Reference Buffer Offset Error	REFIN = 5 V, T _A = 25°C REFIN = 4.5 V, T _A = 25°C REFIN = 4.096 V, T _A = 25°C	-100	±25	+100	μV μV μV
Reference Buffer Offset Drift			±0.3		μV/°C
Power-On Settling Time			3		ms
EXTERNALLY OVERDRIVEN REFERENCE					
REF Voltage Range	External reference drives REF (REFIN = 0 V) 5.3 V ≤ VDD_5V ≤ 5.5 V 4.8 V ≤ VDD_5V ≤ 5.25 V 4.75 V ≤ VDD_5V ≤ 5.25 V	4.95	5 4.5 4.096	5.05 4.146	V V V
REF Current					
AD4030-24	f _S = 2 MSPS		1.8		μA
AD4032-24	f _S = 500 KSPS		0.5		μA
REF Input Capacitance			2		μF
DIGITAL INPUTS					
Logic Levels	1.14 V ≤ V _{IO} ≤ 1.89 V				
Input Voltage Low (V _{IL})		-0.3		+0.35 × V _{IO}	V
Input Voltage High (V _{IH})		0.65 × V _{IO}		V _{IO} + 0.3	V
Input Current Low (I _{IL})		-10		+10	μA
Input Current High (I _{IH})		-10		+10	μA
Input Pin Capacitance			2		pF
DIGITAL OUTPUTS					
Pipeline Delay	1.14 V ≤ V _{IO} ≤ 1.89 V				
Output Voltage Low (V _{OL})	I _{SINK} = 2 mA			0.25 × V _{IO}	V
Output Voltage High (V _{OH})	I _{SOURCE} = 2 mA	0.75 × V _{IO}			V

SPECIFICATIONS

Table 1.

Parameter	Test Conditions/Comments	Min	Typ	Max	Unit
POWER SUPPLIES					
VDD_5V	REF = 5 V	5.3	5.4	5.5	V
	REF = 4.5 V	4.8	5	5.25	V
	REF = 4.096 V	4.75	5	5.25	V
VDD_1.8V		1.71	1.8	1.89	V
VIO ³		1.14		1.89	V
Standby Current					
VDD_5V			500		μA
VDD_1.8V			90		μA
VIO			< 1		μA
Shutdown Current					
VDD_5V			5		μA
VDD_1.8V			5		μA
VIO			< 1		μA
Operating Current, AD4030-24					
VDD_5V	2 MSPS VDD_5V = 5.4 V		2.7	3.2	mA
VDD_1.8V	VDD_1.8V = 1.8 V		8.2	11.2	mA
VIO	VIO = 1.8 V, 1-lane SDO		0.6		mA
Operating Current, AD4032-24					
VDD_5V	500 kSPS VDD_5V = 5.4 V		1.1	1.5	mA
VDD_1.8V	VDD_1.8V = 1.8 V		2.1	3.1	mA
VIO	VIO = 1.8 V, 1-lane SDO		0.15		mA
Power Dissipation					
	2 MSPS		30	39	mW
	500 kSPS		10	14.2	mW
t _{RESET_DELAY}	After power-on, delay from VDD_5V and VDD_1.8V valid to RST assertion	3			ms
t _{RESET_PW}	RST pulse width	50			ns
TEMPERATURE RANGE					
Specified Performance	T _{MIN} to T _{MAX}	-40		+125	°C

¹ The acquisition phase is the time available for the input sampling capacitors to acquire a new input with the ADC running at a throughput rate of 2 MSPS for the AD4030-24 or 500 kSPS for the AD4032-24.

² See the low frequency noise plot in [Figure 24](#). 1/f noise is canceled internally by auto-zeroing. Noise spectral density is substantially uniform from dc to f_S/2.

³ When VIO < 1.4 V, Bit IO2X must be set to 1. See the [Output Driver Register](#) section.

TIMING SPECIFICATIONS

VDD_5V = 5.4 V, VDD_1.8V = 1.8 V, VIO = 1.8 V, REFIN = 5 V, input common mode = 2.5 V, f_S = 2 MSPS for the AD4030-24 or 500 kSPS for the AD4032-24, and all specifications are T_{MIN} to T_{MAX}, unless otherwise noted. Typical values are at T_A = 25°C. See [Figure 2](#) for the timing voltage levels. For VIO < 1.4 V, Bit IO2X must be set to 1.

Table 2. Digital Timing Interface

Parameter ¹	Symbol	Min	Typ	Max	Unit	
Conversion Time: CNV Rising Edge to Data Available	t _{CONV}	264	282	300	ns	
Acquisition Phase ²	t _{ACQ}	AD4030-24	244	260	275	ns
		AD4032-24	1744	1760	1775	ns
		Time Between Conversions	t _{CYC}			
AD4030-24		500			ns	
AD4032-24		2000			ns	

SPECIFICATIONS

Table 2. Digital Timing Interface

Parameter ¹	Symbol	Min	Typ	Max	Unit
CNV High Time	t_{CNVH}	10			ns
CNV Low Time	t_{CNVL}	20			ns
Internal Oscillator Frequency	f_{OSC}	75.1	80	84.7	MHz

¹ Timing specifications assume a 5 pF load capacitance on digital output pins. t_{CONV} , t_{CYC} , t_{SCK} , and t_{SCKOUT} are production tested. All other timing specifications are guaranteed by characterization and design.

² The acquisition phase is the time available for the input sampling capacitors to acquire a new input with the ADC running at a throughput rate of 2 MSPS for the AD4030-24 or 500 kSPS for the AD4032-2.

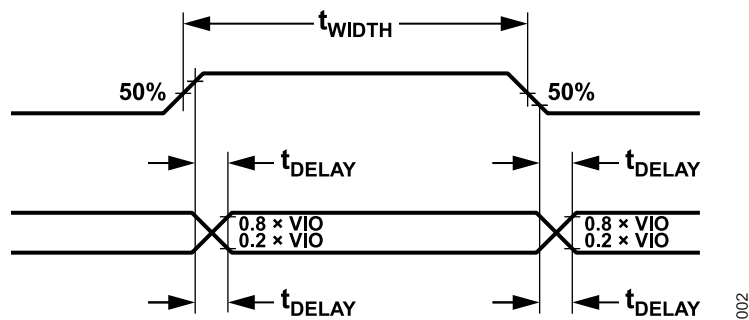

Figure 2. Voltage Levels for Timing

Table 3. Register Read and Write Timing

Parameter	Symbol	Min	Typ	Max	Unit
\overline{CS} Pulse Width	t_{CSPW}	10			ns
SCK Period	t_{SCK}				
VIO > 1.71 V		11.6			ns
VIO > 1.14 V		12.3			ns
SCK Low Time	t_{SCKL}	5.2			ns
SCK High Time	t_{SCKH}	5.2			ns
SCK Falling Edge to Data Remains Valid	t_{HSDO}	2.1			ns
SCK Falling Edge to Data Valid Delay	t_{DSDO}				
VIO > 1.71 V				9.4	ns
VIO > 1.14 V				11.8	ns
\overline{CS} Rising Edge to SDO High Impedance	t_{CSDIS}			9	ns
SDI Valid Setup Time to SCK Rising Edge	t_{SSDI}	1.5			ns
SDI Valid Hold Time from SCK Rising Edge	t_{HSDI}	1.5			ns
\overline{CS} Falling Edge to First SCK Rising Edge	t_{CSSCK}				
VIO > 1.71 V		11.6			ns
VIO > 1.14 V		12.3			ns
Last SCK Edge to \overline{CS} Rising Edge	t_{SCKCS}	5.2			ns

SPECIFICATIONS

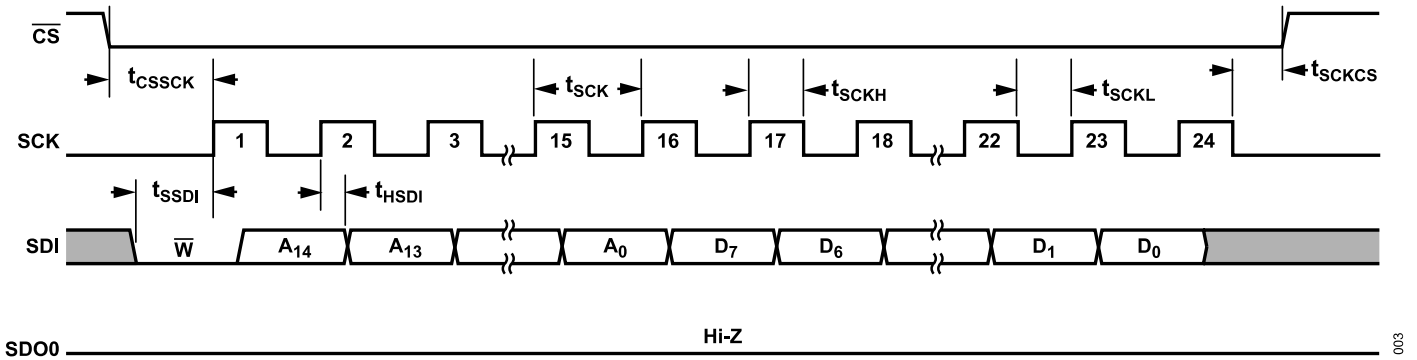

Figure 3. Register Configuration Mode Write Timing

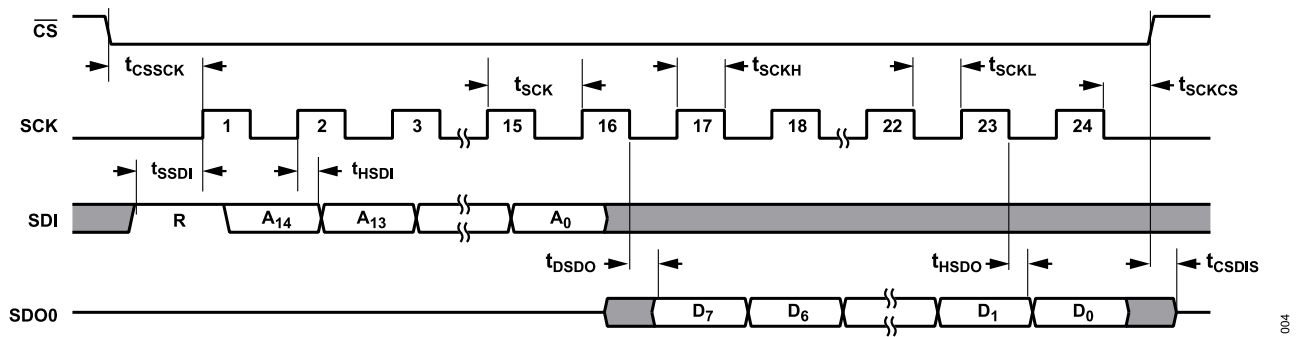

Figure 4. Register Configuration Mode Read Timing

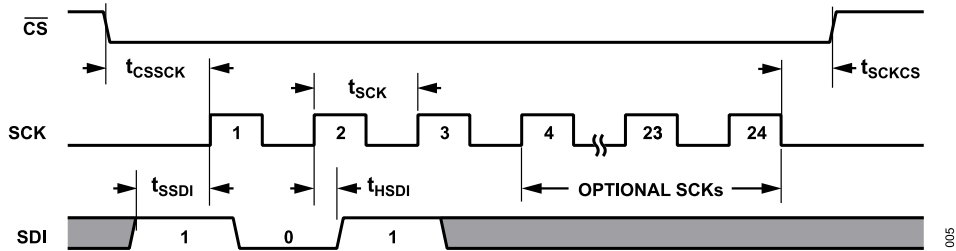

Figure 5. Register Configuration Mode Command Timing

Table 4. SPI-Compatible Mode Timing

Parameter	Symbol	Min	Typ	Max	Unit
SCK Period	t_{SCK}	9.8			ns
VIO > 1.71 V		12.3			ns
VIO > 1.14 V					ns
SCK Low Time	t_{SCKL}	4.2			ns
VIO > 1.71 V		5.2			ns
VIO > 1.14 V					ns
SCK High Time	t_{SCKH}	4.2			ns
VIO > 1.71 V		5.2			ns
VIO > 1.14 V					ns
SCK Falling Edge to Data Remains Valid	t_{HSDO}	1.4			ns
SCK Falling Edge to Data Valid Delay	t_{DSDO}				ns
VIO > 1.71 V				5.6	ns
VIO > 1.14 V				8.1	ns

SPECIFICATIONS

Table 4. SPI-Compatible Mode Timing

Parameter	Symbol	Min	Typ	Max	Unit
$\overline{\text{CS}}$ Falling Edge to SDO Valid	t_{CSEN}				ns
VIO > 1.71 V				6.8	ns
VIO > 1.14 V				9.3	ns
$\overline{\text{CS}}$ Falling Edge to First SCK Rising Edge	t_{CSSCK}				
VIO > 1.71 V		9.8			ns
VIO > 1.14 V		12.3			ns
Last SCK Edge to $\overline{\text{CS}}$ Rising Edge	t_{SCKCS}	4.2			ns
$\overline{\text{CS}}$ Rising Edge to SDO High Impedance	t_{CSDIS}			9	ns
$\overline{\text{CS}}$ Falling Edge to BUSY Rising Edge	t_{CSBUSY}		6		ns

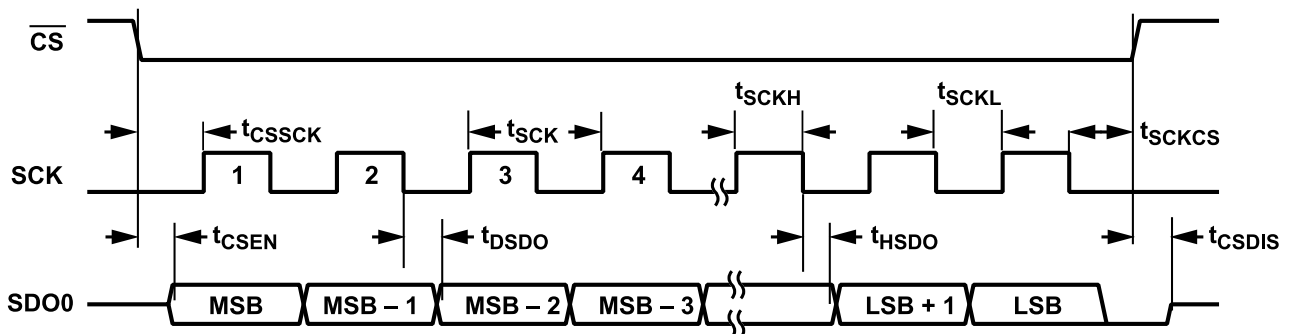

Figure 6. SPI Clocking Mode 1-Lane SDR Timing

Table 5. Echo Clock Mode Timing, SDR, 1-Lane

Parameter	Symbol	Min	Typ	Max	Unit
SCK Period	t_{SCK}				
VIO > 1.71 V		9.8			ns
VIO > 1.14 V		12.3			ns
SCK Low Time, SCK High Time	$t_{\text{SCKL}}, t_{\text{SCKH}}$				
VIO > 1.71 V		4.2			ns
VIO > 1.14 V		5.2			ns
SCK Rising Edge to Data/SCKOUT Remains Valid	t_{HSDO}	1.1			ns
SCK Rising Edge to Data/SCKOUT Valid Delay	t_{DSDO}				
VIO > 1.71 V				5.6	ns
VIO > 1.14 V				8.1	ns
$\overline{\text{CS}}$ Falling Edge to First SCK Rising Edge	t_{CSSCK}				
VIO > 1.71 V		9.8			ns
VIO > 1.14 V		12.3			ns
Skew Between Data and SCKOUT	t_{SKEW}	-0.4	0	+0.4	ns
Last SCK Edge to $\overline{\text{CS}}$ Rising Edge	t_{SCKCS}	4.2			ns
$\overline{\text{CS}}$ Rising Edge to SDO High Impedance	t_{CSDIS}			9	ns

SPECIFICATIONS

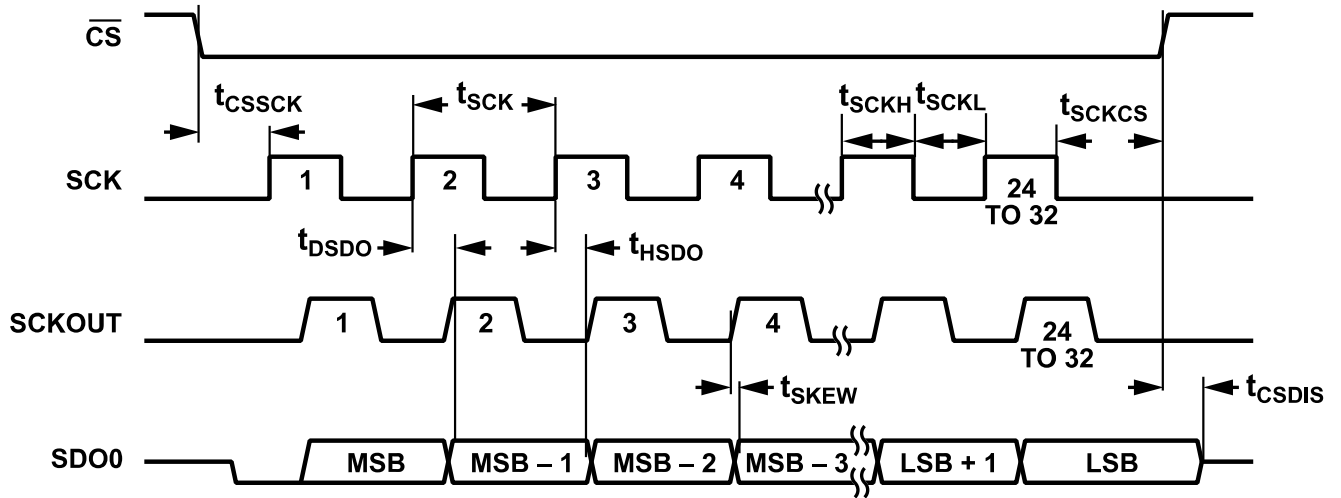

Figure 7. Echo Clock Mode Timing, SDR, 1-Lane

Table 6. Echo Clock Mode Timing, DDR, 1-Lane

Parameter	Symbol	Min	Typ	Max	Unit
SCK Period	t_{SCK}	12.3			ns
SCK Low Time, SCK High Time	t_{SCKL} , t_{SCKH}	5.2			ns
SCK Edge to Data/SCKOUT Remains Valid	t_{HSDO}	1.1			ns
SCK Edge to Data/SCKOUT Valid Delay	t_{DSDO}			6.2	ns
VIO > 1.71 V				8.7	ns
VIO > 1.14 V					ns
\overline{CS} Falling Edge to First SCK Rising Edge	t_{CSSCK}	12.3			ns
Skew Between Data and SCKOUT	t_{SKEW}	-0.4	0	+0.4	ns
Last SCK Edge to \overline{CS} Rising Edge	t_{SCKCS}	9			ns
\overline{CS} Rising Edge to SDO High Impedance	t_{CSDIS}			9	ns

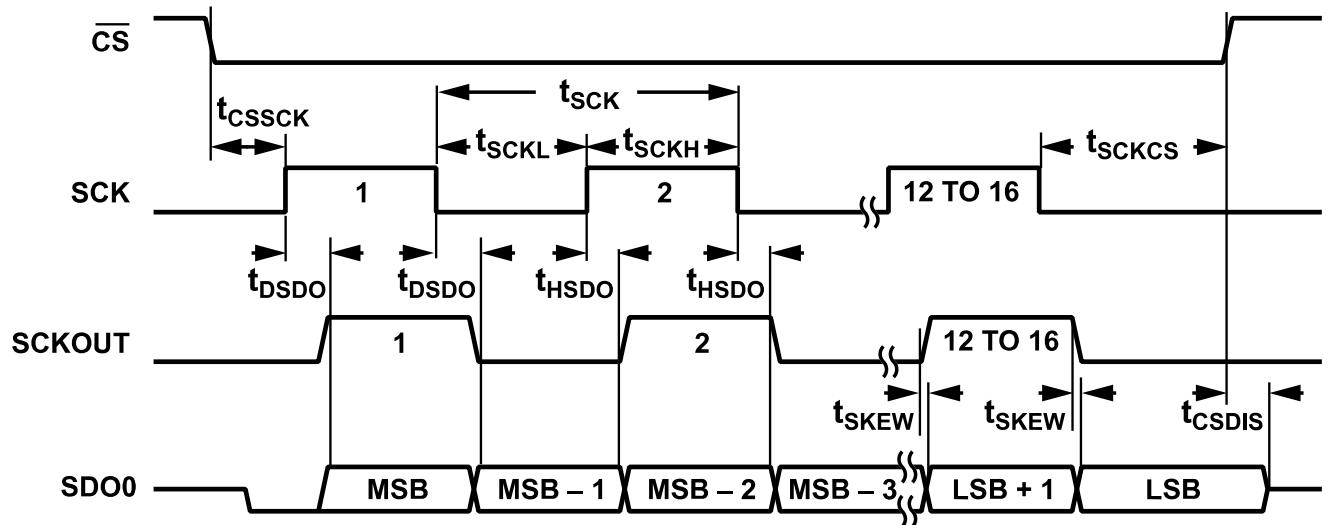

Figure 8. Echo Clock Mode Timing, DDR, 1-Lane

SPECIFICATIONS

Table 7. Host Clock Mode Timing

Parameter	Symbol	Min	Typ	Max	Unit
SCK Period	t_{SCKOUT}	11.8	12.5	13.3	ns
OSC_DIV = No Divide		23.6	25	26.6	ns
OSC_DIV = Divide by 2		47.4	50	53.2	ns
OSC_DIV = Divide by 4					
SCK Low Time	$t_{SCKOUTL}$	$0.45 \times t_{SCKOUT}$		$0.55 \times t_{SCKOUT}$	ns
SCK High Time	$t_{SCKOUTH}$	$0.45 \times t_{SCKOUT}$		$0.55 \times t_{SCKOUT}$	ns
\overline{CS} Falling Edge to First SCKOUT Rising Edge	$t_{DSCKOUT}$				
VIO > 1.71 V		10	13.6	19	ns
VIO > 1.14 V		10	15	21	ns
Skew Between Data and SCKOUT	t_{SKEW}	-0.4	0	+0.4	ns
Last SCKOUT Edge to \overline{CS} Rising Edge	$t_{SCKOUTCS}$	5.2			ns
\overline{CS} Rising Edge to SDO High Impedance	t_{CSDIS}			9	ns

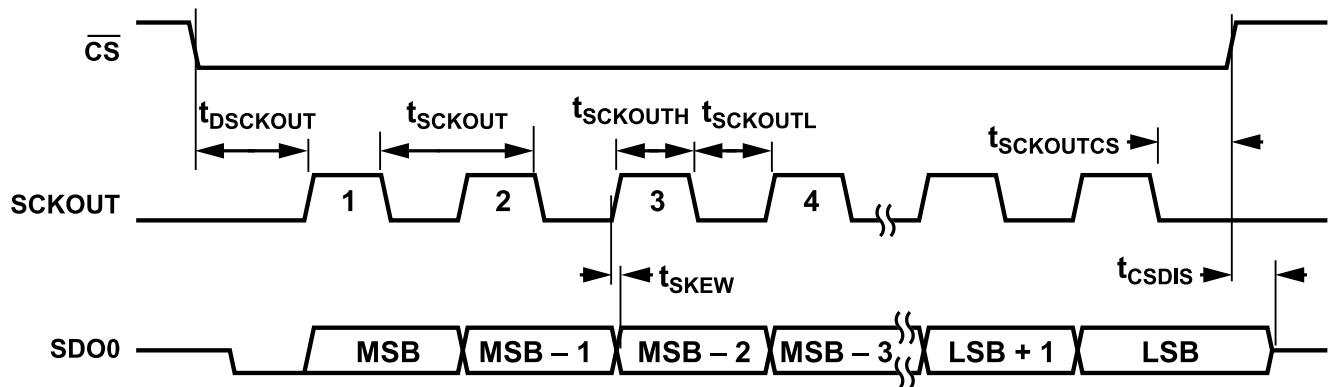

Figure 9. Host Clock Mode Timing, SDR, 1-Lane

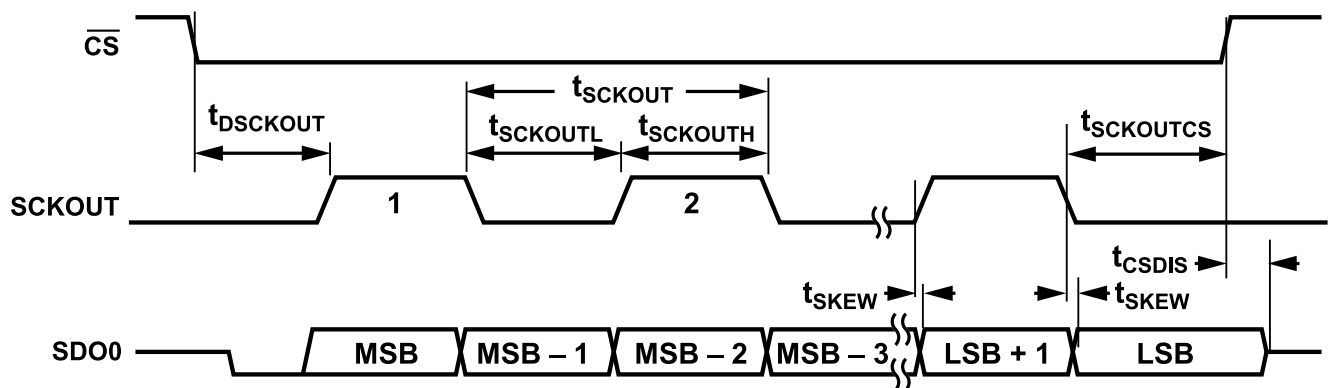

Figure 10. Host Clock Mode Timing, DDR, 1-Lane

ABSOLUTE MAXIMUM RATINGS

Table 8.

Parameter	Rating
Analog Inputs	
IN+, IN-, REFIN to GND	-0.3 V to VDD_5V + 0.3 V
Supply Voltage	
VDD_5V, REF to GND	-0.3 V to +6.0 V
VDD_1.8V, VIO to GND	-0.3 V to +2.1 V
Digital Inputs to GND	-0.3 V to VIO + 0.3 V
CNV to GND	-0.3 V to VIO + 0.3 V
Digital Outputs to GND	-0.3 V to VIO + 0.3 V
Storage Temperature Range	-55°C to +150°C
Operating Junction Temperature Range	-40°C to +125°C
Maximum Reflow (Package Body) Temperature	260°C

Stresses at or above those listed under Absolute Maximum Ratings may cause permanent damage to the product. This is a stress rating only; functional operation of the product at these or any other conditions above those indicated in the operational section of this specification is not implied. Operation beyond the maximum operating conditions for extended periods may affect product reliability.

THERMAL RESISTANCE

Thermal performance is directly linked to printed circuit board (PCB) design and operating environment. Careful attention to PCB thermal design is required.

Table 9. Thermal Resistance

Package Type	θ_{JA}	θ_{JC}	Unit
05-08-1797	35	16	°C/W

ELECTROSTATIC DISCHARGE (ESD) RATINGS

The following ESD information is provided for handling of ESD-sensitive devices in an ESD protected area only.

Human body model (HBM) per ANSI/ESDA/JEDEC JS-001.

Field induced charged device model (FICDM) per ANSI/ESDA/JEDEC JS-002.

ESD Ratings for AD4030-24/AD4032-24

Table 10. AD4030-24/AD4032-24, 64-Ball CSP_BGA

ESD Model	Withstand Threshold (kV)	Class
HBM	4	3A
FICDM	1.25	C3

ESD CAUTION



ESD (electrostatic discharge) sensitive device. Charged devices and circuit boards can discharge without detection. Although this product features patented or proprietary protection circuitry, damage may occur on devices subjected to high energy ESD. Therefore, proper ESD precautions should be taken to avoid performance degradation or loss of functionality.

PIN CONFIGURATION AND FUNCTION DESCRIPTIONS

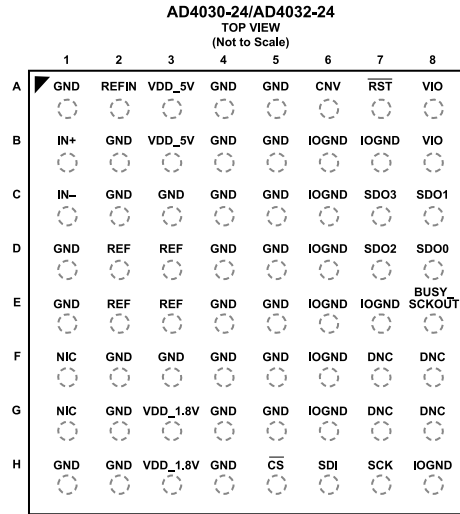

NOTES
 1. NIC = NOT INTERNALLY CONNECTED. THESE PINS ARE NOT CONNECTED INTERNALLY.
 2. DNC = DO NOT CONNECT TO THESE PINS. THEY ARE INTERNALLY CONNECTED TO DIGITAL OUTPUT DRIVERS IN HIGH-Z MODE.
 3. NIC = NOT INTERNALLY CONNECTED. THESE PINS ARE NOT CONNECTED INTERNALLY.

Figure 11. Pin Configuration

Table 11. Pin Function Descriptions

Pin No.	Mnemonic	Type ¹	Description
A1, A4, A5, B2, B4, B5, C2 to C5, D1, D4, D5, E1, E4, E5, F2 to F5, G2, G4, G5, H1, H2, H4	GND	P	Power Supply Ground.
A2	REFIN	AI	Buffered Reference Input. When using the internal reference buffer, drive REFIN with 4.096 V to 5 V (referred to ground). To disable the reference buffer, tie REFIN to ground and drive REF with 4.096 V to 5 V.
A3, B3	VDD_5V	P	5 V Power Supply. The range of VDD_5V depends on the reference value, 5.3 V to 5.5 V for a 5 V reference, and 4.75 V to 5.25 V for a 4.096 V reference. This pin has a 1 μF bypass capacitor inside the package.
A6	CNV	DI	Convert Input. A rising edge on this input powers up the device and initiates a new conversion. This signal must have low jitter to achieve the specified performance of the ADC. Logic levels are determined by the VIO pin.
A7	RST	DI	Reset Input (Active Low). Asynchronous device reset.
A8, B8	VIO	P	Input/Output Interface Digital Power. Nominally, this pin is at the same supply as the host interface (1.8 V, 1.5 V, or 1.2 V). This pin has a 0.2 μF bypass capacitor inside the package. For VIO < 1.4 V, Bit IO2X of the output driver register must be set to 1.
B1	IN+	AI	Positive Analog Input.
B6, B7, C6, D6, E6, E7, F6, G6, H8	IOGND	P	VIO Ground. Connect to the same ground plane as all GND pins.
C1	IN-	AI	Negative Analog Input.
C7	SDO3	DO	Serial Data Output. The conversion result is output on this pin. It is synchronized to SCK.
C8	SDO1	DO	Serial Data Output. The conversion result is output on this pin. It is synchronized to SCK.
D2, D3, E2, E3	REF	AI	Optional Unbuffered Reference Input. Drive REF with 4.096 V to 5 V (referred to ground). This pin has a 2 μF bypass capacitor inside the package. When using the internal reference buffer, do not connect REF.
D7	SDO2	DO	Serial Data Output. The conversion result is output on this pin. It is synchronized to SCK.
D8	SDO0	DO	Serial Data Output. The conversion result is output on this pin. It is synchronized to SCK.
E8	BUSY_SCKOUT	DO	BUSY Indicator in SPI Clocking Mode. This pin goes high at the start of a new conversion and returns low when the conversion has finished. Logic levels are determined by the VIO pin. When SCKOUT is enabled, this pin function is either an echo of the incoming SCK from the host controller or a clock sourced by the internal oscillator.

PIN CONFIGURATION AND FUNCTION DESCRIPTIONS

Table 11. Pin Function Descriptions

Pin No.	Mnemonic	Type ¹	Description
F1	NIC		Not Internally Connected. These pins are not connected internally.
F7, F8, G7, G8	DNC		Do Not Connect to These Pins. They are internally connected to digital output drivers in high-Z mode.
G1	NIC		Not Internally Connected. These pins are not connected internally.
G3, H3	VDD_1.8V	P	1.8 V Power Supply. The range of VDD_1.8V is 1.71 V to 1.89 V. This pin has a 1 μ F bypass capacitor inside the package.
H5	\overline{CS}	DI	Chip Select Input (Active Low).
H6	SDI	DI	Serial Data Input.
H7	SCK	DI	Serial Data Clock Input. When the device is selected (\overline{CS} = low), the conversion result is shifted out by this clock.

¹ AI is analog input, P is power, DI is digital input, and DO is digital output.

TYPICAL PERFORMANCE CHARACTERISTICS

VDD_5V = 5.4 V, VDD_1.8V = 1.8 V, VIO = 1.8V, REFIN = 5 V, input common mode = 2.5 V, $f_S = 2$ MSPS for the AD4030-24 or 500 kSPS for the AD4032-24, and all specifications T_{MIN} to T_{MAX} , unless otherwise noted. Typical values are at $T_A = 25^\circ\text{C}$.

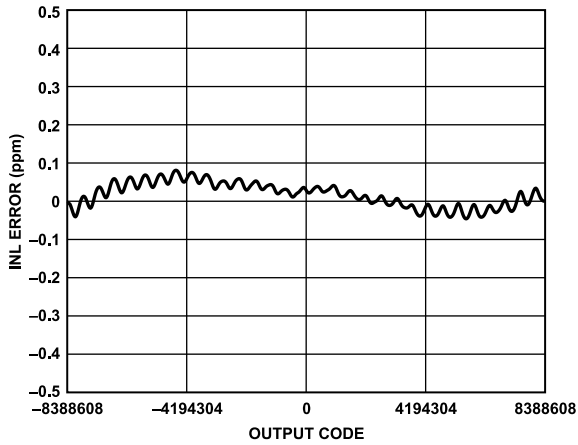

Figure 12. INL Error vs. Output Code, Differential Input

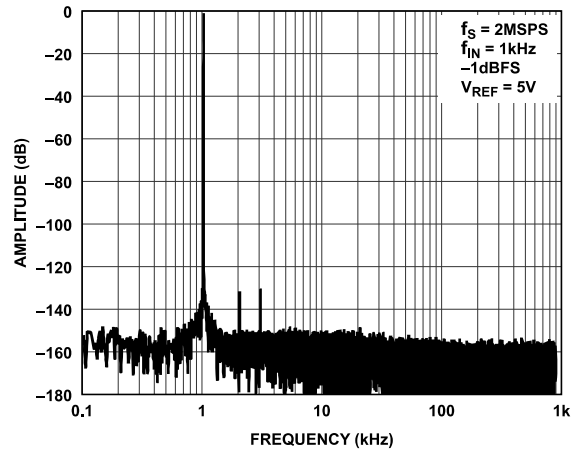

Figure 15. FFT, 2 MSPS, $f_{IN} = 1$ kHz, $V_{REF} = 5$ V

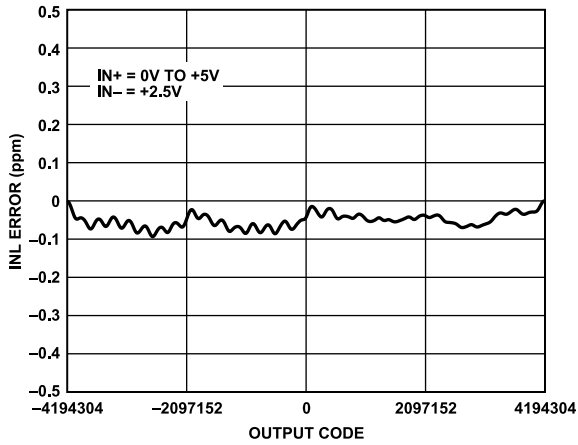

Figure 13. INL Error vs. Output Code, Single-Ended Input

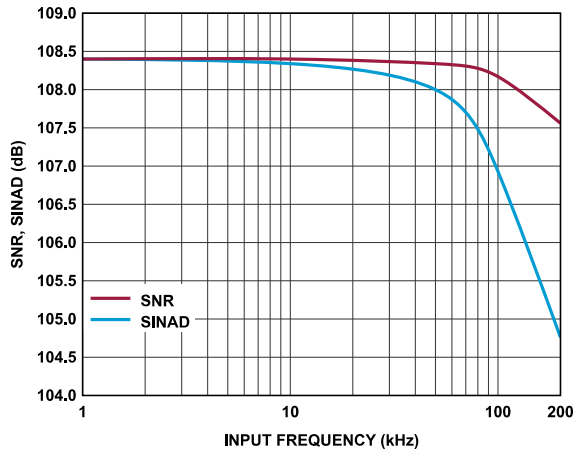

Figure 16. SNR, SINAD vs. Input Frequency

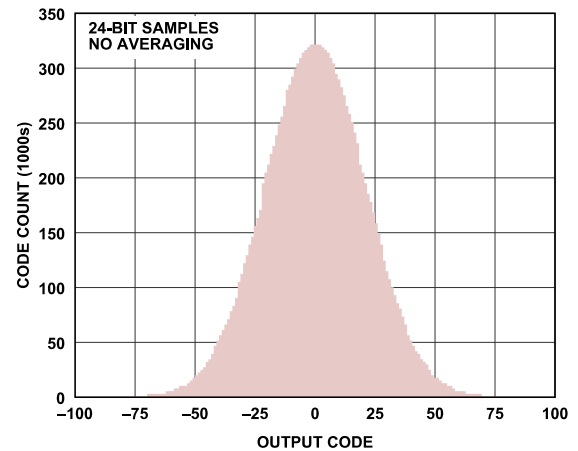

Figure 14. Code Histogram for Shorted Inputs

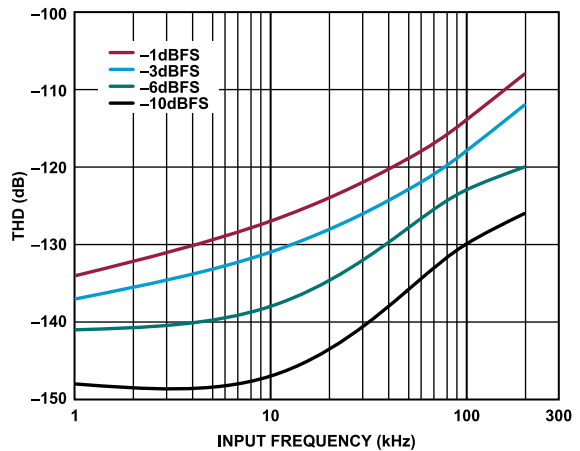

Figure 17. THD vs. Input Frequency, Various Amplitudes

TYPICAL PERFORMANCE CHARACTERISTICS

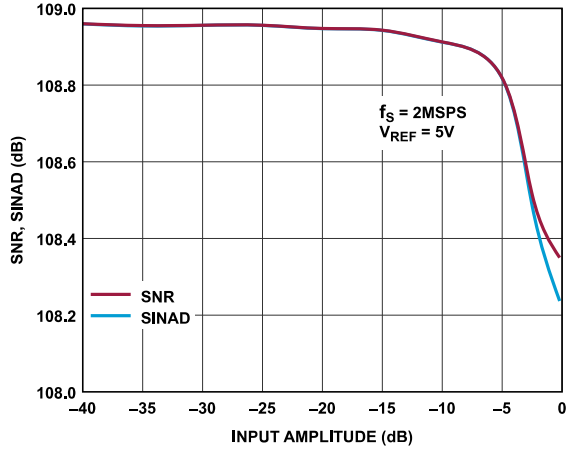

Figure 18. SNR, SINAD vs. Input Amplitude, $f_{IN} = 1 \text{ kHz}$

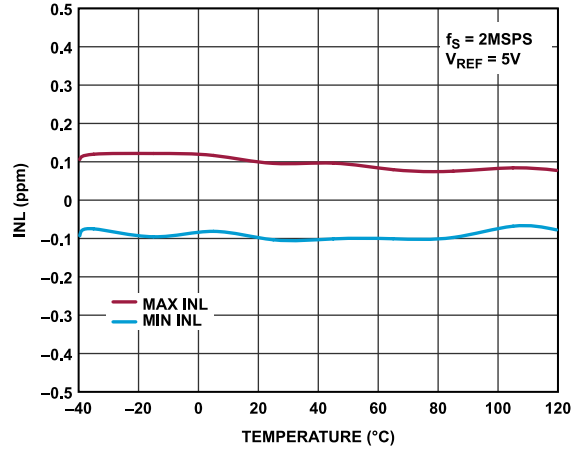

Figure 21. INL vs. Temperature

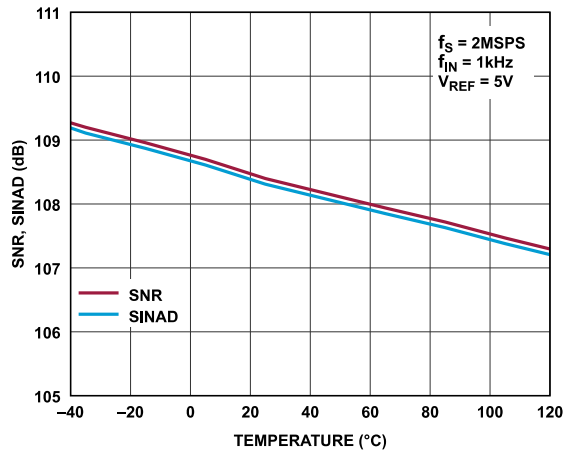

Figure 19. SNR, SINAD vs. Temperature, $f_{IN} = 1 \text{ kHz}$

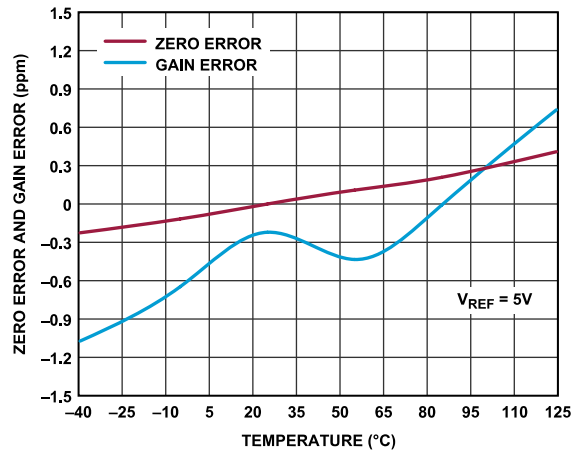

Figure 22. Zero Error and Gain Error vs. Temperature

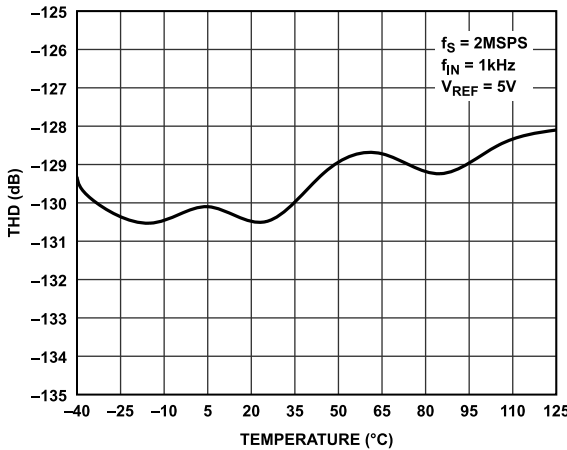

Figure 20. THD vs. Temperature, $f_{IN} = 1 \text{ kHz}$

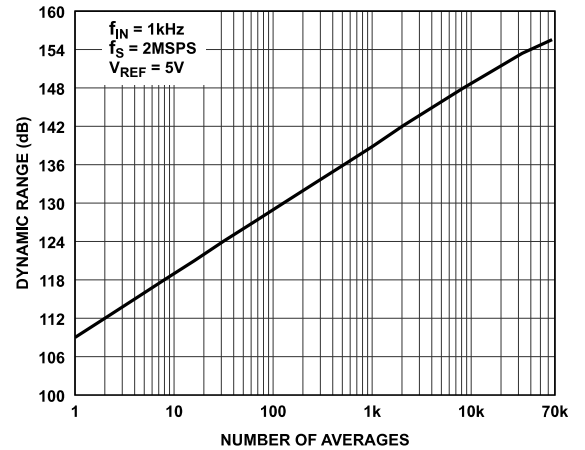

Figure 23. Dynamic Range vs. Number of Averages

TYPICAL PERFORMANCE CHARACTERISTICS

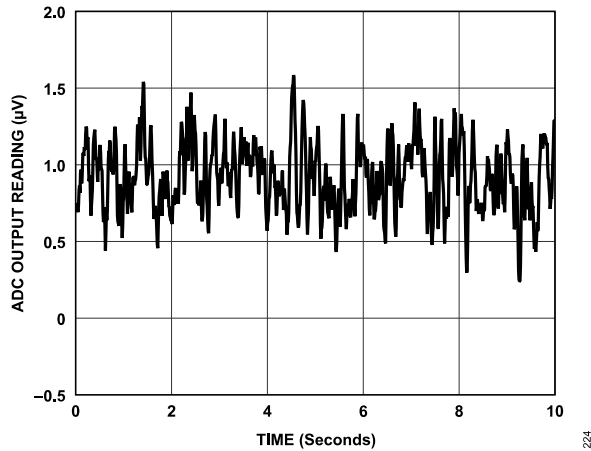

Figure 24. Low Frequency Noise (Output Data Rate = 19.5 SPS After Averaging Blocks of 2048 Samples)

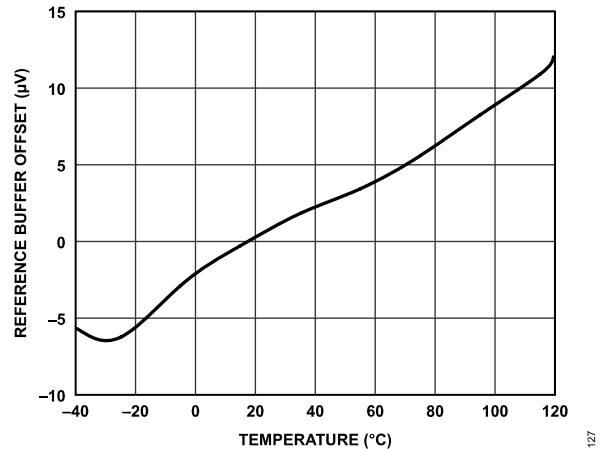

Figure 27. Reference Buffer Offset vs. Temperature

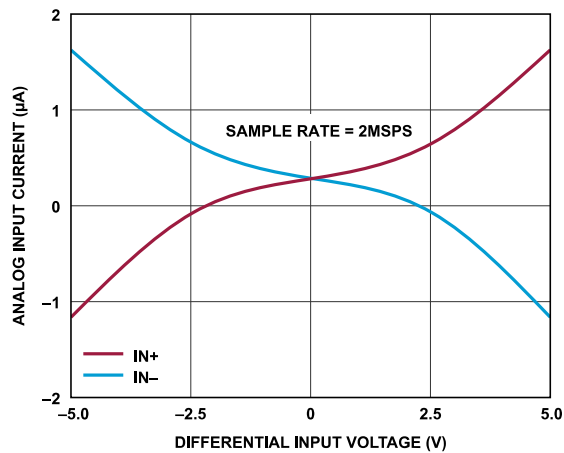

Figure 25. Analog Input Current vs. Differential Input Voltage, AD4030-24, 2 MSPS

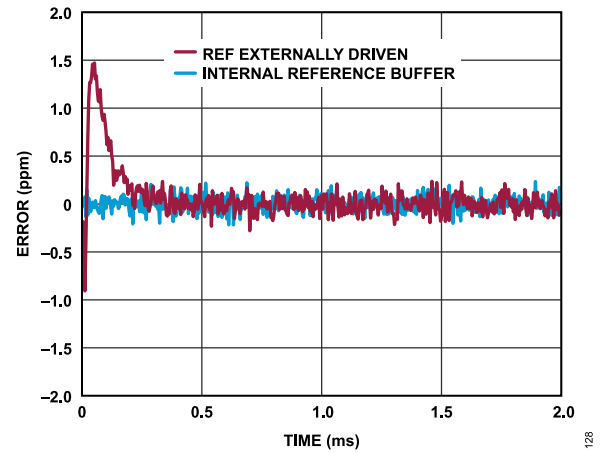

Figure 28. Error During Conversion Burst After Long Idle Time

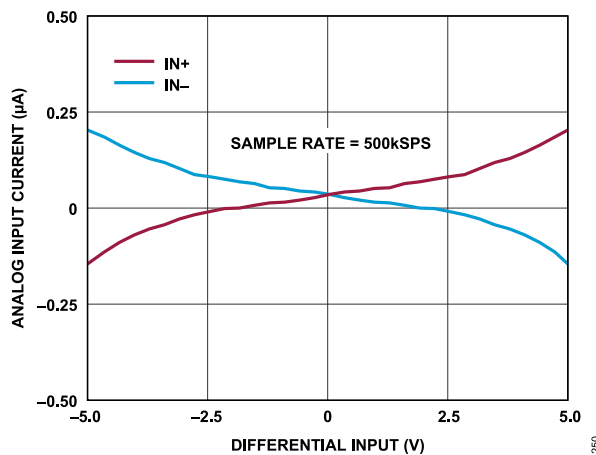

Figure 26. Analog Input Current vs. Differential Input, AD4032-24, 500 kSPS

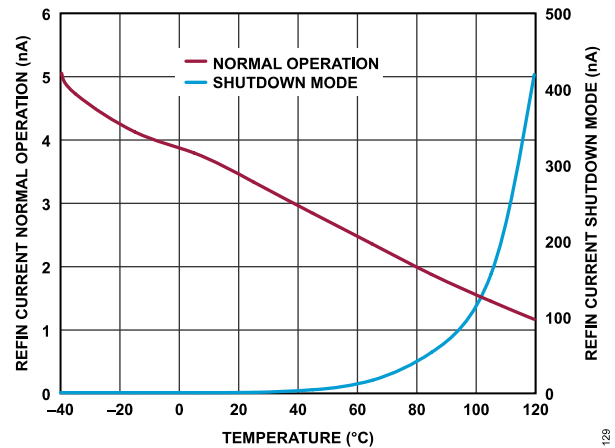

Figure 29. REFIN Current Normal Operation and REFIN Current Shutdown Mode vs. Temperature

TYPICAL PERFORMANCE CHARACTERISTICS

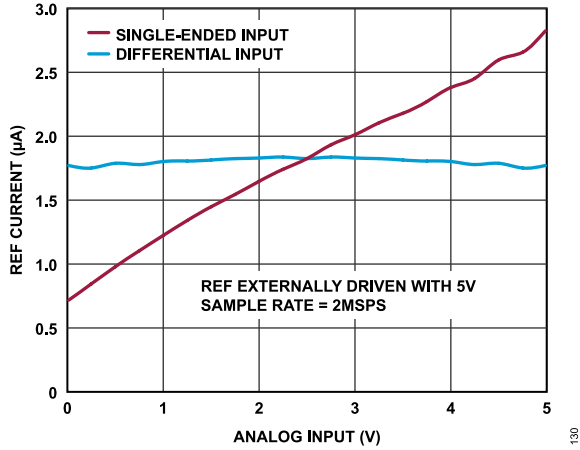

Figure 30. REF Current vs. Analog Input, AD4030-24, 2 MSPS

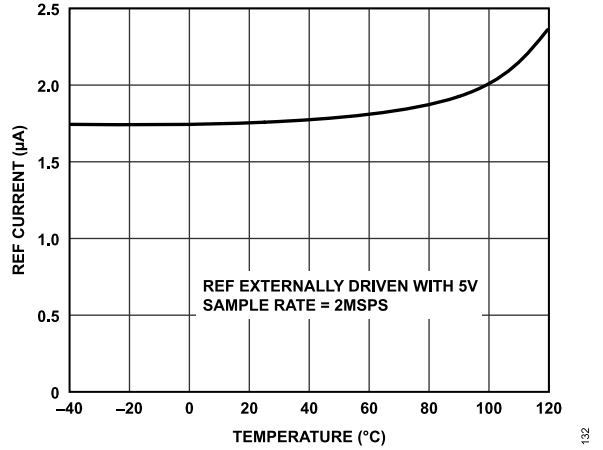

Figure 33. REF Current vs. Temperature

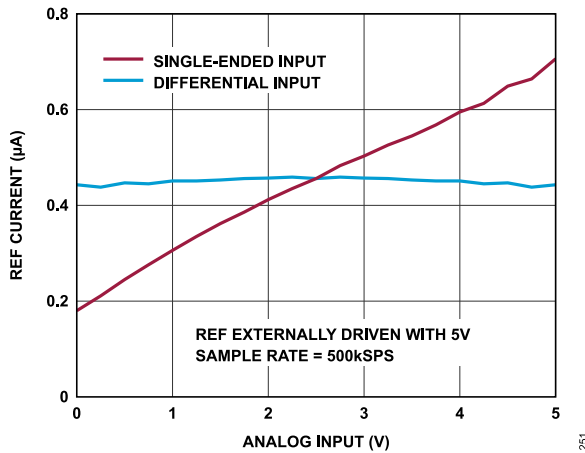

Figure 31. REF Current vs. Analog Input, AD4032-24, 500 kSPS

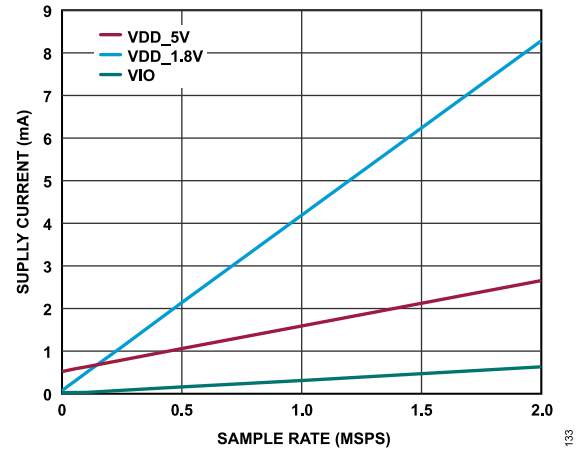

Figure 34. Supply Current vs. Sample Rate

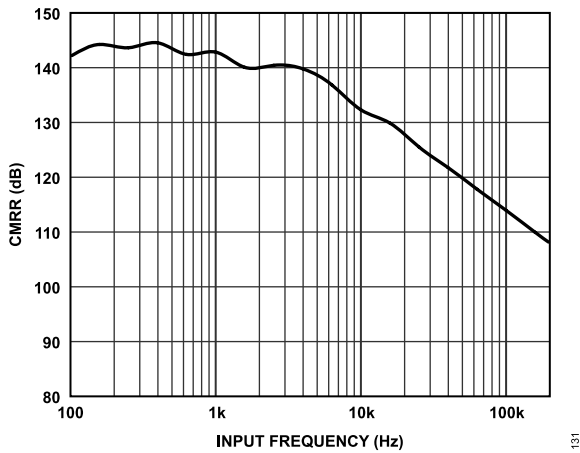

Figure 32. Common-Mode Rejection Ratio (CMRR) vs. Input Frequency

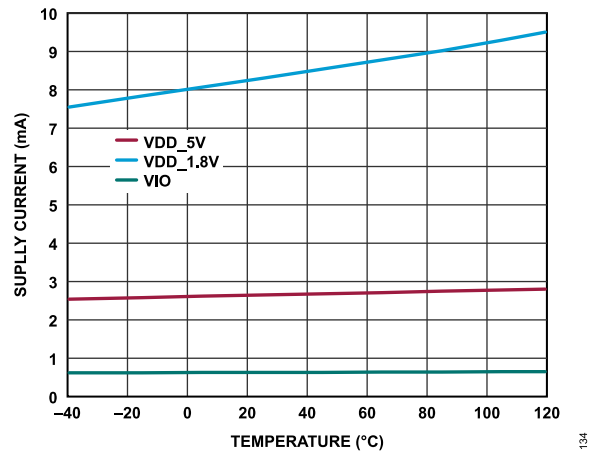

Figure 35. Supply Current vs. Temperature, AD4030-24, 2 MSPS

TYPICAL PERFORMANCE CHARACTERISTICS

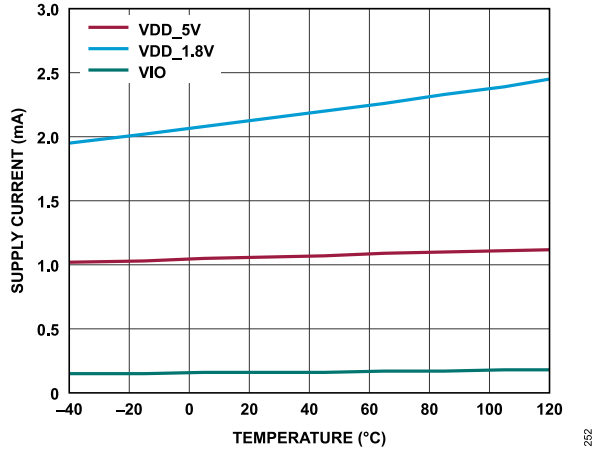

Figure 36. Supply Current vs. Temperature, AD4032-24, 500 kSPS

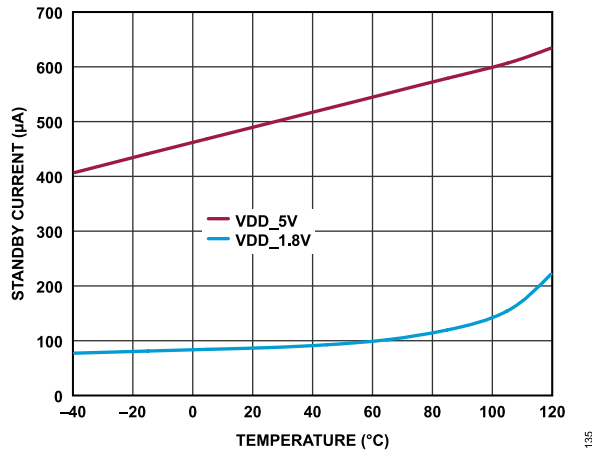

Figure 37. Standby Current vs. Temperature

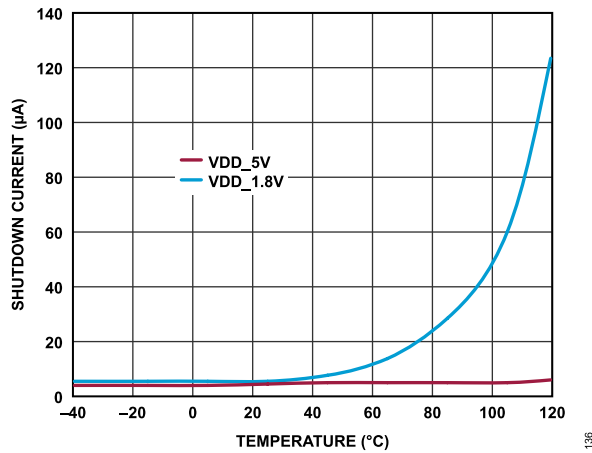

Figure 38. Shutdown Current vs. Temperature

TERMINOLOGY**INTEGRAL NONLINEARITY ERROR (INL)**

INL is the deviation of each individual code from a line drawn from negative full scale through positive full scale. The point used as negative full scale occurs $\frac{1}{2}$ LSB before the first code transition. Positive full scale is defined as a level $1\frac{1}{2}$ LSB beyond the last code transition. The deviation is measured from the middle of each code to the true straight line (see [Figure 40](#)).

DIFFERENTIAL NONLINEARITY ERROR (DNL)

In an ideal ADC, code transitions are 1 LSB apart. DNL is the maximum deviation from this ideal value. It is often specified in terms of resolution for which no missing codes are guaranteed.

ZERO ERROR (ZE)

Zero error is the difference between the ideal midscale voltage, 0 V, and the actual voltage producing the midscale output code, 0 LSB.

GAIN ERROR (GE)

The first transition (from 100 ... 00 to 100 ... 01) occurs at a level $\frac{1}{2}$ LSB above nominal negative full scale. The last transition (from 011 ... 10 to 011 ... 11) occurs for an analog voltage $1\frac{1}{2}$ LSB below the nominal full scale. The gain error is the deviation of the difference between the actual level of the last transition and the actual level of the first transition from the difference between the ideal levels.

SPURIOUS-FREE DYNAMIC RANGE (SFDR)

SFDR is the difference, in decibels (dB), between the rms amplitude of a full-scale input signal and the peak spurious signal.

EFFECTIVE NUMBER OF BITS (ENOB)

ENOB is a measurement of the resolution with a sine wave input. It is related to SINAD as follows: $ENOB = (SINAD_{dB} - 1.76)/6.02$. ENOB is expressed in bits.

TOTAL HARMONIC DISTORTION (THD)

THD is the ratio of the rms sum of the first five harmonic components to the rms value of a full-scale input signal and is expressed in decibels.

DYNAMIC RANGE (DR)

Dynamic range is the rms voltage of a full-scale sine wave to the total rms voltage of the noise measured. The value for dynamic range is expressed in decibels. It is measured with a signal at -60 dBFS so that it includes all noise sources and DNL artifacts.

SIGNAL-TO-NOISE RATIO (SNR)

SNR is the ratio of the rms voltage of a full-scale sine wave to the rms sum of all other spectral components below the Nyquist frequency, excluding harmonics and dc. The value for SNR is expressed in decibels.

SIGNAL-TO-NOISE-AND-DISTORTION (SINAD) RATIO

SINAD is the ratio of the rms voltage of a full-scale sine wave to the rms sum of all other spectral components that are less than the Nyquist frequency, including harmonics but excluding dc. The value of SINAD is expressed in decibels.

APERTURE DELAY

Aperture delay is the measure of the acquisition performance and is the time between the rising edge of the CNV input and when the input signal is held for a conversion.

TRANSIENT RESPONSE

Transient response is the time required for the ADC to acquire a full-scale input step to ± 1 LSB accuracy.

COMMON-MODE REJECTION RATIO (CMRR)

CMRR is the ratio of the power in the ADC output at the frequency, f , to the power of a 4.5 V p-p sine wave applied to the input common-mode voltage of frequency, f .

$$CMRR \text{ (dB)} = 10 \times \log(P_{ADC_IN}/P_{ADC_OUT})$$

where:

P_{ADC_IN} is the common-mode power at the frequency, f , applied to the inputs.

P_{ADC_OUT} is the power at the frequency, f , in the ADC output.

POWER SUPPLY REJECTION RATIO (PSRR)

PSRR is the ratio of the power in the ADC output at the frequency, f , to the power of a 200 mV p-p sine wave applied to the ADC VDD supply of frequency, f .

$$PSRR \text{ (dB)} = 10 \times \log(P_{VDD_IN}/P_{ADC_OUT})$$

where:

P_{VDD_IN} is the power at the frequency, f , at the VDD pin.

P_{ADC_OUT} is the power at the frequency, f , in the ADC output.

THEORY OF OPERATION

Figure 39 shows the basic functions of the AD4030-24/AD4032-24.

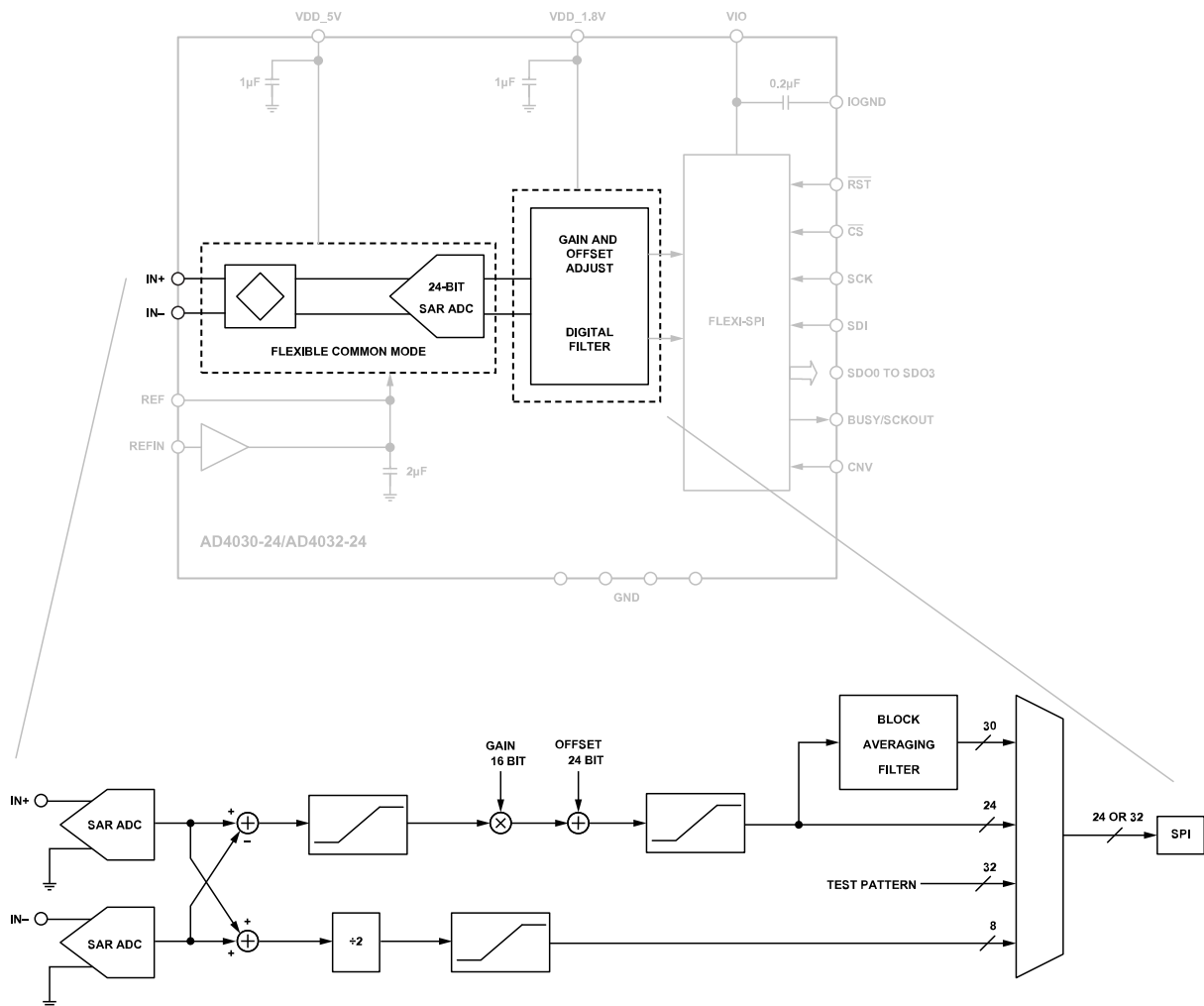

Figure 39. AD4030-24/AD4032-24 Functional Block Diagram and Signal Processing Architecture

OVERVIEW

The AD4030-24/AD4032-24 are low noise, low power, high speed, 24-bit successive approximation register (SAR) ADCs. The AD4030-24 is capable of converting 2,000,000 samples per second (2 MSPS), and the AD4032-24 is capable of converting 500,000 samples per second (500 kSPS). It offers several analog and digital features to ease system design. The analog features include a wide common-mode range that eases level shifting requirements as well as an extended fully differential input range of $\pm(65/64) \times V_{REF}$, easing the margin requirements on signal conditioning.

The AD4030-24/AD4032-24 have an integrated reference buffer with an integrated decoupling capacitor to minimize the external components on board. The on-chip track-and-hold circuitry does not exhibit any pipeline delay or latency, making this circuitry ideal for control loops and high speed applications. The digital features include offset correction, gain adjustment, and averaging, which offload the host processor. The user can configure the device for

one of several output code formats (see the [Summary of Selectable Output Data Formats](#) section).

The AD4030-24/AD4032-24 use a Flexi-SPI, allowing the data to be accessed via multiple SPI lanes, which relaxes clocking requirements for the host SPI controller. An echo clock mode is also available to assist in data clocking, simplifying the use of isolated data interfaces. The AD4030-24/AD4032-24 has a valid first conversion after exiting power-down mode. The architecture achieves ± 0.9 ppm INL maximum, with no missing codes at 24 bits and 108.4 dB SNR. The AD4030-24 dissipates only 30 mW at 2 MSPS.

CONVERTER OPERATION

The AD4030-24/AD4032-24 operate in two phases, acquisition phase and conversion phase. In the acquisition phase, the internal track-and-hold circuitry is connected to each input pin (IN+, IN-) and samples the voltage on each pin independently. Issuing a

THEORY OF OPERATION

rising edge pulse on the CNV pin initiates a conversion. The rising edge pulse on the CNV pin also asserts the BUSY signal to indicate a conversion in progress. At the end of the conversion, the BUSY signal is deasserted. The conversion result is a 24-bit code representing the input voltage difference and an 8-bit code representing the input common-mode voltage. Depending on the device configuration, this conversion result can be processed digitally and latched into the internal output register. The acquisition circuit on each input pin is also precharged to the previous sample voltage, which minimizes the kick-back charge to the input driver. The host processor retrieves the output code via the SDO pins that are internally connected to the internal output register.

TRANSFER FUNCTION

In the default configuration, the AD4030-24/AD4032-24 digitizes the full-scale difference voltage of $2 \times V_{REF}$ into 2^{24} levels, resulting in an LSB size of $0.596 \mu\text{V}$ with $V_{REF} = 5 \text{ V}$. Note that 1 LSB at 24 bits is approximately 0.06 ppm. The ideal transfer function is shown in Figure 40. The differential output data is in twos complement format. Table 12 summarizes the mapping of input voltages to differential output codes.

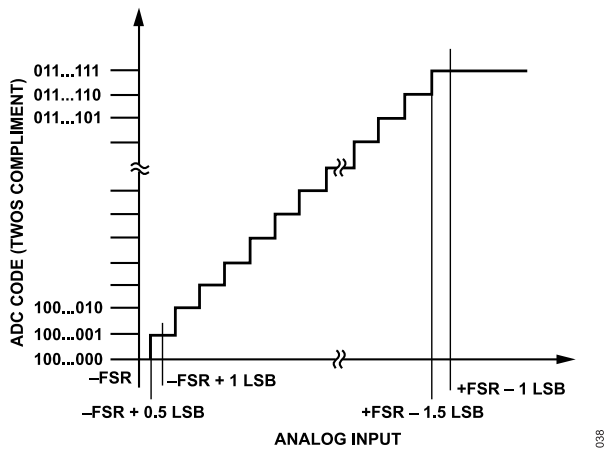

Figure 40. ADC Ideal Transfer Function for the Differential Output Codes (FSR Is Full-Scale Range)

Table 12. Input Voltage to Output Code Mapping

Description	Analog Input Voltage Difference	Digital Output Code (Twos Complement, Hex)
FSR - 1LSB	$(8388607 \times V_{REF})/(8388608)$	0x7FFFFFFF
Midscale + 1LSB	$V_{REF}/(8388608)$	0x000001
Midscale	0 V	0x000000
Midscale - 1LSB	$-V_{REF}/(8388608)$	0xFFFFFFFF
-FSR + 1LSB	$-(8388607 \times V_{REF})/(8388608)$	0x800001
-FSR	$-V_{REF}$	0x800000

ANALOG FEATURES

The AD4030-24/AD4032-24 has a precharging circuit as part of the internal track-and-hold circuitry, which charges the internal sampling capacitors to the previously sampled input voltage. This reduces the charge kickback, making the precharge circuit on the

analog input of the AD4030-24/AD4032-24 easier to drive than other conventional SAR ADCs. The reduced kickback, combined with a longer acquisition phase, means reduced settling requirements on the driving amplifier. This combination also allows the use of larger resistor values, which are beneficial for improving amplifier stability. Furthermore, the bandwidth of the RC filter is reduced, resulting in lower noise and/or power consumption of the signal chain.

The common-mode voltage is not restricted except by the absolute voltage range for each input (from $-1/128 \times V_{REF}$ to $129/128 \times V_{REF}$). The analog inputs can be modeled by the equivalent circuit shown in Figure 41. In the acquisition phase, each input pin has approximately 116 pF input capacitance (C_{IN}) from the sampling capacitor in series with 19Ω on resistance (R_{ON}) of the sampling switch. During conversion phase, each input has the capacitance of the input pin (C_{PIN}), which is about 4 pF. Any signal that is common to both inputs is reduced by the common-mode rejection of the ADC. During conversion, the analog inputs draw only a small leakage current.

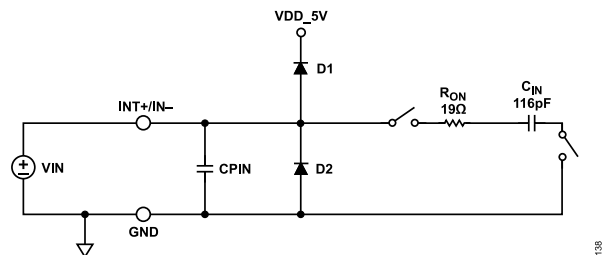

Figure 41. Equivalent Circuit for the AD4030-24/AD4032-24 Differential Analog Input

Each input is sampled independently. The conversion results do not saturate assuming each of the inputs are within the specified full-scale input range. Note that digital domain saturation occurs if the digital offset and digital gain parameters are configured to map the conversion result to numeral values that exceed the full-scale digital range (-2^{23} to $+2^{23} - 1$ for the 24-bit word). An input voltage difference up to $\pm(65/64) \times V_{REF}$ can be captured and converted without saturation by setting the digital gain parameter to a value < 1 .

The slew rate at the analog input pins must be less than $400 \text{ V}/\mu\text{s}$ during the acquisition phase and less than $30 \text{ V}/\mu\text{s}$ at the sampling moment to ensure good performance. This can be ensured by choosing values for the external RC circuit that allow the RC time-constant to be more than 12.5 ns ($R \times C > 12.5\text{e-}9$).

DIGITAL SAMPLE PROCESSING FEATURES

The AD4030-24/AD4032-24 supports several digital and data processing features that can be applied to the signal samples. These features are enabled and disabled via the control registers of the AD4030-24/AD4032-24. Figure 39 contains a signal processing architecture block diagram showing the available digital and data processing features.

THEORY OF OPERATION

Full-Scale Saturation

The conversion results saturate digitally (before any post-processing) when either or both inputs exceed the analog limits specified herein. After applying offset and gain scaling, the results are truncated to 24-bit representation (saturating at maximum 0x7FFFFF and minimum 0x800000). Care must be taken to avoid unintentional saturation, especially when applying digital offset and/or gain scaling. See the [Digital Offset Adjust](#) and [Digital Gain](#) sections for more details on the use of these features.

Common-Mode Output

When the host controller writes 0x1 or 0x2 to the OUT_DATA_MD bit field of the modes register (see the [Modes Register](#) section), an 8-bit code representing the input common-mode voltage is appended to the 16-bit or 24-bit code representing the input voltage difference. The LSB size of the 8-bit code is $V_{REF}/256$. The 8-bit code saturates at 0 and 255 when the common mode input voltage is 0 V and V_{REF} , respectively. The 8-bit code is not affected by digital offset and gain scaling, which is applied only to the code representing the input voltage difference.

Block Averaging

The AD4030-24/AD4032-24 provide a block averaging filter (SINC1) with programmable block length 2^N , $N = 1, 2, 3, \dots, 16$. The filter is reset after processing each block of 2^N samples. The filter is enabled by writing 0x3 to the OUT_DATA_MD bit field of the modes register (see the [Modes Register](#) section) as well as a value ($1 \leq N \leq 16$) to the AVG_VAL bit field in the averaging mode register (see the [Averaging Mode Register](#) section). In this configuration, the output sample word is 32 bits. The 30 most significant bits (MSBs) represent the numerical value of the 24-bit codes averaged in blocks of 2^N samples. The automatic scaling allows the 24 MSBs of the 30-bit code are equal to the 24-bit codes when averaging blocks of constant values. The 31st bit (OR) is an overrange warning bit that is high when one or more samples in the block are subject to saturation. The 32nd bit (SYNC) is high once every 2^N conversion cycles to indicate when the average values are updated at the end of each block of samples. See the [Digital Sample Processing Features](#) section for more information.

The effective data rate in averaging mode is $f_{CNV}/2^N$. The reset value of N in the AVG_VAL bit field is 0x00 (no averaging). [Figure 57](#) shows an example timing diagram in averaging mode. [Figure 42](#) shows the frequency response of the filter for an $N = 1, 2, 3, 4, 5$.

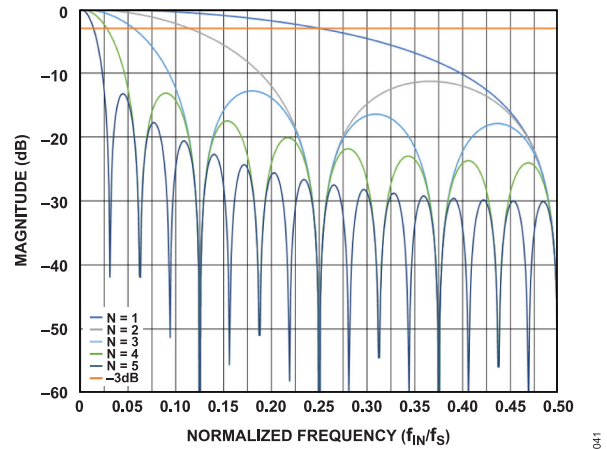

Figure 42. Frequency Response Examples for the Block Averaging Filter

Digital Offset Adjust

The ADC can be programmed to add a 24-bit signed offset value to the sample data (see the [Register Details](#) section). When adding an offset to the samples, it is possible to cause the sample data to saturate numerically. The user must take this into account when using the offset feature. The default value is 0x000000. See the [Offset Registers](#) section for more details.

Digital Gain

The ADC can be programmed to apply a 16-bit unsigned digital gain (Register 0x1C and Register 0x1D) to the digital samples (see the [Register Details](#) section). The gain is applied to each sample based on the following equation:

$$\text{Code}_{\text{OUT}} = \text{Code}_{\text{IN}} \times (\text{USER_GAIN}/0x8000)$$

where:

$$0x0000 \leq \text{USER_GAIN} \leq 0xFFFF$$

The effective gain range is 0 to 1.99997. Note that applying gain to the samples may cause numerical saturation. The default value is 0x8000 (gain = 1). To measure input voltage differences exceeding $\pm V_{REF}$, set the gain less than the unity to avoid the numerical saturation of the 24-bit, 16-bit, or 30-bit output differential codes. See the [Gain Registers](#) section for more details.

Test Pattern

To facilitate functional testing and debugging of the SPI, the host controller can write a 32-bit test pattern to the AD4030-24/AD4032-24 (see the [Test Pattern Registers](#) section). The value written to the test pattern registers is output using the normal sample cycle timing. The 32-bit test pattern output mode is enabled by writing 0x4 to the OUT_DATA_MD bit field of the modes register (see the [Modes Register](#) section). The default value stored in the test pattern registers is 0x5A5A0F0F.

THEORY OF OPERATION

Summary of Selectable Output Data Formats

Figure 43 summarizes the output data formats that are available on the AD4030-24/AD4032-24, which are selected in the modes register (see the [Modes Register](#) section). Note that the OR and SYNC flags are each 1-bit.

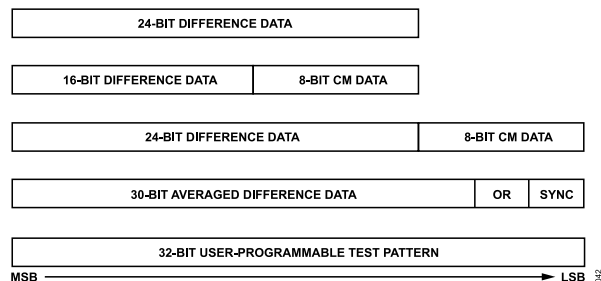

Figure 43. Summary of Selectable Output Sample Formats

APPLICATIONS INFORMATION

TYPICAL APPLICATION DIAGRAMS

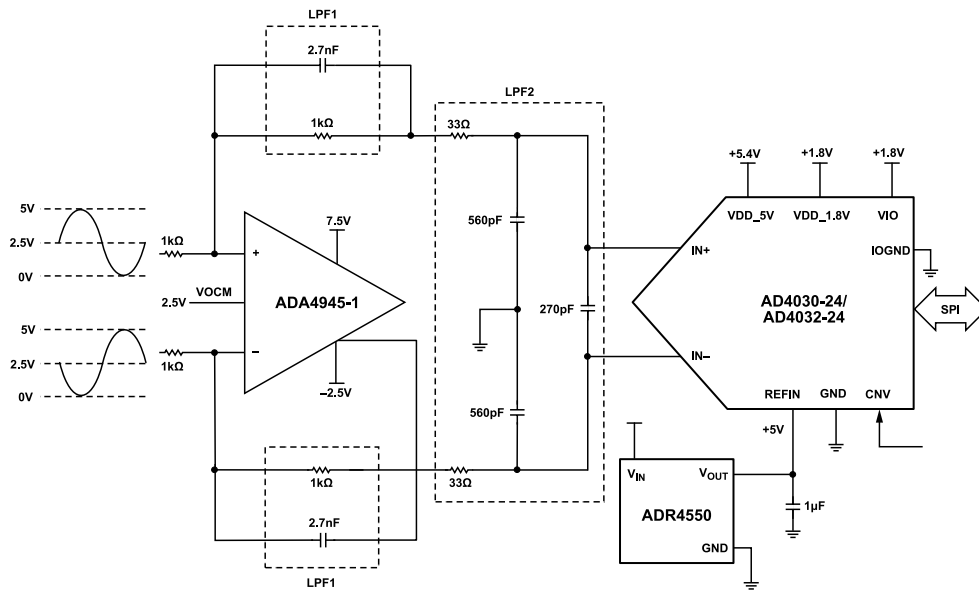

Figure 44. Differential Driver Analog Front End

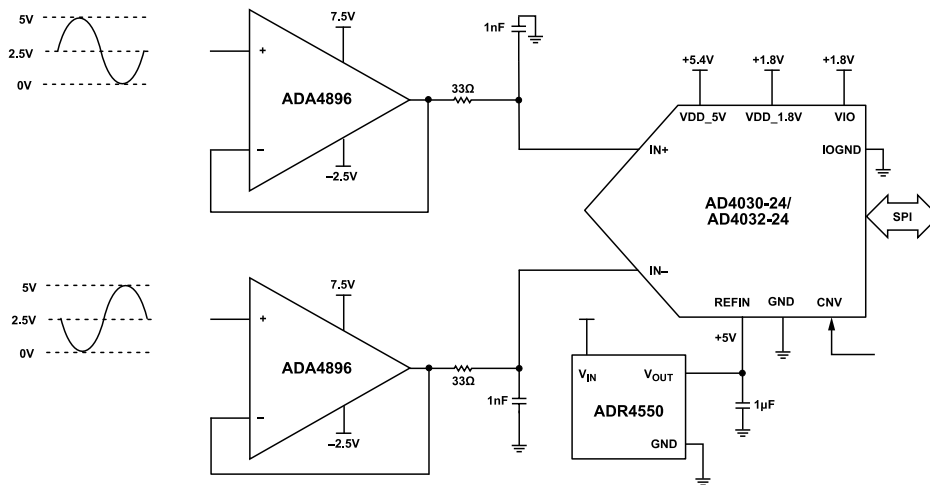

Figure 45. Unity Gain Dual Buffer Configuration

ANALOG FRONT-END DESIGN

Driver Amplifier Choice

Figure 44 shows two examples for driving the AD4030-24/AD4032-24. Either can be combined with an upstream stage that provides additional signal conditioning. Both can accommodate single-ended or differential inputs. To take advantage of the SNR and THD performance of the AD4030-24/AD4032-24, it is important to choose a driver amplifier that has low enough noise and THD sufficient to meet the application requirements. In addition to the amplifiers shown in Figure 44, the LTC6227 is another driver option. Analog Devices offers several companion driver amplifiers that can be found on the [ADC drivers](#) web page.

REFERENCE CIRCUITRY DESIGN

The AD4030-24/AD4032-24 require an external reference to define its input range. This reference must be 4.096 V to 5 V. An optimal choice for the reference is the [ADR4550](#) or [ADR4540](#). These ADCs have several features that reduce the charge pulled from the reference, making the AD4030-24/AD4032-24 much easier to use than other ADCs. For most applications, the reference can drive the REF pin, which has an internal precision buffer that isolates the reference from the ADC circuitry. The buffer has a high input impedance and small input current (5 nA typical) that allows multiple ADCs to share a common reference. An RC circuit between the reference and the REF pin can be used to filter

APPLICATIONS INFORMATION

reference noise (see [Figure 46](#)). Suggested values are $100\ \Omega < R < 1\ \text{k}\Omega$, and $C \geq 10\ \mu\text{F}$.

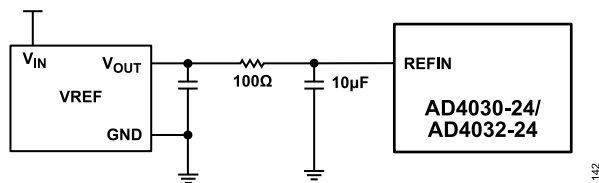

Figure 46. Reference with Noise Filter

For the best possible gain error, the internal buffer can be disabled ($\text{REFIN} = 0\ \text{V}$) and an external reference can be used to drive the REF pins. The current drawn by the REF pins is small ($< 2\ \mu\text{A}$) and depends on the sample rate and output code (see [Figure 30](#)). An internal $2\ \mu\text{F}$ capacitor on the REF pins provides optimal reference

bypassing and simplifies PCB design by reducing component count and layout sensitivity.

In applications where a burst of samples is taken after idling for long periods, as shown in [Figure 47](#), the reference current (I_{REF}) quickly goes from approximately $0\ \mu\text{A}$ to a maximum of $1.8\ \mu\text{A}$ at 2 MSPS from approximately $0\ \mu\text{A}$ to $0.5\ \mu\text{A}$ at 500 kSPS. This step in dc current draw triggers a transient response in the reference that must be considered because any deviation in the reference output voltage affects the accuracy of the output code. If the reference is driving the REF pins, the internal buffer is able to handle these transitions (see [Figure 28](#)). When the REF pins are being driven with no external buffer, and the transient response of the reference is important, the fast settling [LTC6655LN-5](#) reference is recommended.

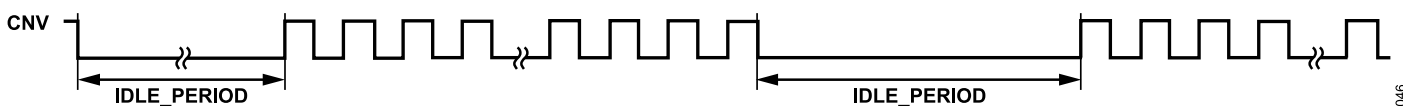

Figure 47. CNV Waveform Showing Burst Sampling

APPLICATIONS INFORMATION

DEVICE RESET

The AD4030-24/AD4032-24 provide two options for performing a device reset using the serial interface. A hardware reset is initiated by pulsing the voltage on the $\overline{\text{RST}}$ pin low. A software reset is initiated by setting both the SW_RESET and SW_RESETX bits in the Interface Configuration A register to 1 in the same write instruction (see the [Interface Configuration A Register](#) section).

Performing a hardware or software reset asserts the RESET_OCCURRED bit in the digital diagnostics register (see the [Digital Diagnostics Register](#) section). The RESET_OCCURRED bit is cleared by writing the bit with a 1. RESET_OCCURRED can be used by the digital host to confirm that the AD4030-24/AD4032-24 has executed a device reset.

The AD4030-24/AD4032-24 is designed to generate a power-on reset (POR) when VDD_5V and VDD_1.8V are first applied. A POR resets the state of the user configuration registers and asserts the RESET_OCCURRED bit. If VDD_5V or VDD_1.8V drops to less than its specified operating range, a POR occurs. It is recommended to perform a hardware or software reset after a POR.

[Figure 48](#) shows the timing diagram for performing a device reset using the $\overline{\text{RST}}$ input. The minimum $\overline{\text{RST}}$ pulse width is 50 ns, represented by t_{RESETPW} in [Figure 48](#) and [Table 1](#). A reset must be performed no sooner than 3 ms after the power supplies are valid and stable (this delay is represented by $t_{\text{RESET_DELAY}}$ in [Figure 48](#) and [Table 1](#)).

After a hardware or software reset, no SPI commands or conversions can be started for 750 μs .

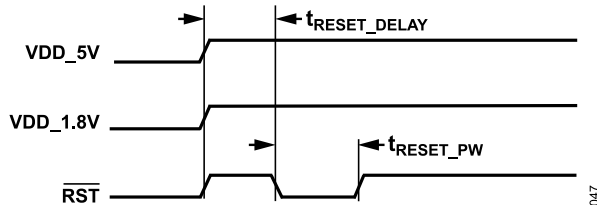

Figure 48. Power-On Reset (POR) Timing

POWER SUPPLIES

The AD4030-24/AD4032-24 do not have any specific power supply sequencing requirements. Care must be taken to adhere to the maximum voltage relationships described in the [Absolute Maximum Ratings](#) section. The voltage range for the VDD_5V supply depends on the chosen reference voltage (see the [Specifications](#) table, Internal Reference Buffer, or Externally Overdriven Reference). [Figure 49](#) shows the minimum and maximum values for VDD_5V with respect to REFIN and REF . VDD_5V voltage values more than the maximum or less than the minimum result in either damage to the device or degraded performance.

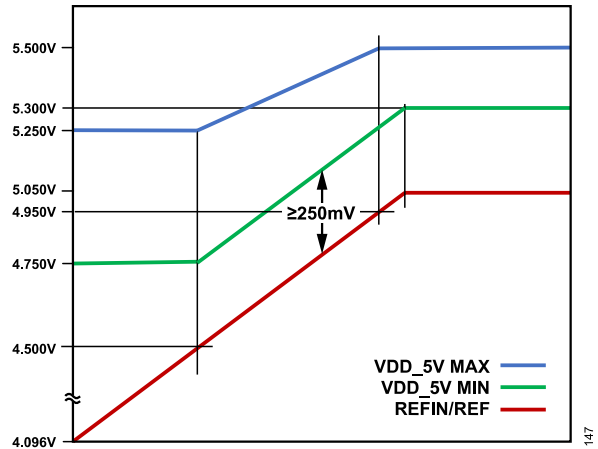

Figure 49. VDD_5V Minimum and Maximum Values for REFIN/REF

The AD4030-24/AD4032-24 have a POR circuit that resets the AD4030-24/AD4032-24 at initial power-up or whenever VDD_5V or VDD_1.8V drops to less than its specified operating range.

Note that the VDD_5V and the VDD_1.8V supplies have internal 1 μF bypass capacitors inside the package, while VIO has an internal 0.2 μF bypass capacitor. These internal capacitors reduce bill of materials (BOM) count and solution size. If the bulk supply bypass capacitors are not close to the ADC, external capacitors can be added next to the ADC. The minimum rise time for all supplies is 100 μs .

Power Consumption States

During a conversion, the power consumption rate of the AD4030-24/AD4032-24 is at its highest. When the conversion is complete, it enters a standby state and much of the internal circuitry is powered down, and current consumption drops to less than 20% relative to the conversion state. To ensure full accuracy, some circuitry, including the reference buffer, remains powered on during the standby state.

The device can be placed into a lower power shutdown state during periods when the convert clock is idle by writing 0x3 to the OPERATING_MODES bit field of the device configuration register (see the [Device Configuration Register](#) section). The default value of this bit field is [00] for normal operating mode. In the shutdown state, the current consumption typically drops to less than 10 μA .

Shutdown Mode

When the ADC enters shutdown mode, the internal reference buffer is disabled and a 500 Ω switch connects the REFIN pins to the REF pin (unless the REFIN pin is grounded and the REF pins are externally driven). This keeps the 2 μF capacitor on the REF pins charged up to allow fast recovery when the ADC exits shutdown mode. Because of this keep-alive switch, there is some charge injected to the REFIN pin when the ADC enters shutdown mode

APPLICATIONS INFORMATION

(400 pC) and exits shutdown mode (5 pC). When exiting shutdown mode, the REF pins are accurate after 30 μ s.

SERIAL INTERFACE

The AD4030-24/AD4032-24 support a multilane SPI serial digital interface with a common bit clock (SCK). The flexible VIO pins supply allows the AD4030-24/AD4032-24 to communicate with any digital logic operating between 1.2 V and 1.8 V. However, for the VIO pins levels less than 1.4 V, the IO2X bit in the output driver register must be set to 1 (see the [Output Driver Register](#) section). The serial output data is clocked out on up to 4 SDO lanes (see [Figure 50](#)). An echo clock mode that is synchronous with the output data is available to ease timing requirements when using isolation on the digital interface. A host clock mode is also available and uses an internal oscillator to clock out the data bits. The [SPI Clocking Mode](#) section, [Echo Clock Mode](#) section, [Host Clock Mode](#) section, [Single Data Rate](#) section, [Dual Data Rate](#) section, [1-Lane Output Data Clocking Mode](#) section, [2-Lane Output Data Clocking Mode](#) section, [4-Lane Output Data Clocking Mode](#) section, and [Data Output Modes Summary](#) section describe the operation of the AD4030-24/AD4032-24 SPI.

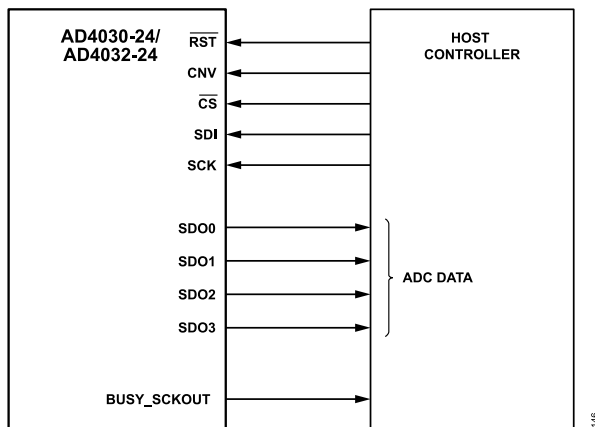

Figure 50. AD4030-24/AD4032-24 Multilane SPI

SPI SIGNALS

The SPI is a multilane interface that is used to both configure the ADC as well as retrieve sampled data. It consists of the following signals:

- ▶ \overline{CS} (input) (chip select). \overline{CS} must be set to low to initiate and enable a data transfer to or from the SDI pins or SDOx pins of the ADC. \overline{CS} timing for reading sample data can be moderated by observing the state of the BUSY pin. For echo clock mode and host clock mode, \overline{CS} timing must be controlled by the host processor because the BUSY_SCKOUT pin is used as the bit clock output for these clocking modes.
- ▶ SDI (input). Serial data input stream from the host controller to the ADC. The SDI signal is only used when writing data into one of the user registers of the AD4030-24/AD4032-24.
- ▶ CNV (input). The CNV signal is sourced by the host controller and initiates a sample conversion. The frequency of the CNV signal determines the sampling rate of the AD4030-24/AD4032-24. The maximum frequency of the CNV clock is 2 MSPS.
- ▶ SCK (input). Serial data clock sourced by the host controller. The maximum SCK rate supported for output data transfer is 100 MHz. For register reads and writes, the maximum SCK rate is 86 MHz for the VIO pins > 1.71 V, and 81 MHz for 1.14 V ≤ the VIO pins < 1.71 V.
- ▶ SDO0 through SDO3 (outputs). Data lanes to the host controller. The number of active data lanes can be either 1, 2, or 4 lanes (see [Table 14](#)). The number of data lanes is configured in the [Modes Register](#) section.
- ▶ BUSY_SCKOUT (output). The behavior of the BUSY_SCKOUT pin is dependent on the selected clocking mode. [Table 13](#) defines the behavior of the BUSY_SCKOUT pin for each clocking mode.

Table 13. BUSY_SCKOUT Pin Behavior vs. Clocking Mode

Clocking Mode	Behavior
SPI Clocking Mode	Valid BUSY_SCKOUT pin signal for the ADC conversion status. The busy signal on the BUSY_SCKOUT pin goes high when a conversion is triggered by the CNV signal. The busy signal on the BUSY_SCKOUT pin goes low when the conversion is complete.
Echo Clock Mode	Bit clock. The BUSY_SCKOUT pin is a delayed version of SCK input.
Host Clock Mode	Bit clock. The BUSY_SCKOUT pin sources the clock signal from the internal oscillator.

Register Access Mode

The AD4030-24/AD4032-24 offer programmable user registers that are used to configure the device as outlined in the [Registers](#) section. By default, at power-up, the device is in conversion mode. Therefore, to access the user registers, a special access command must be sent by the host controller over the SPI, as shown in [Figure 5](#). When this register access command is sent over the SPI, the device enters the register configuration mode. To read back the values from one of the user registers listed in the [Registers](#) section, the host controller must send the pattern shown in [Figure 4](#). To write to one of the user registers, the host controller must send the pattern shown in [Figure 3](#). In either case (read/write), the host controller must always issue 24 clock pulses on SCK line and pull \overline{CS} low for the entire transaction.

After writing to/reading from the appropriate user registers, the host controller must exit the register configuration mode by writing 0x01 to register address 0x0014 as detailed in the EXIT configuration mode register. An algorithm for register read/write access is as follows:

1. Perform a read back from a dummy register address 0x3FFF, to enter the register configuration mode.
2. Read back from or write to the desired user register addresses.
3. Exit the register configuration mode by writing 0x01 to register address 0x0014. Exiting register configuration mode causes the register updates to take effect.

SERIAL INTERFACE

Stream Mode

The AD4030-24/AD4032-24 also offer a way to perform bulk register read/write transactions, while the AD4030-24/AD4032-24 is in register configuration mode. To perform bulk read/write registers transactions, \overline{CS} must be kept low and SCK pulses must be issued in multiples of 8 as each register is only one byte (8 bits) wide. In stream mode, only address decrementing is allowed, meaning that the user can read back from/write to the initial register address. It is recommended that register accesses in stream mode

be applied to register blocks with contiguous addresses. However, it is possible to address registers that are not present in the register map. To do so, simply write all zeros to these registers, or, when reading back, simply discard the contents read from these registers, since it is random data. See the [Registers](#) section to see which register address is valid and continuous. For example, to read back a 24-bit offset value in one shot, the user must issue 24 SCK pulses starting from Register Address 0x0018. [Figure 51](#) shows timing diagram for bulk read starting at a given address.

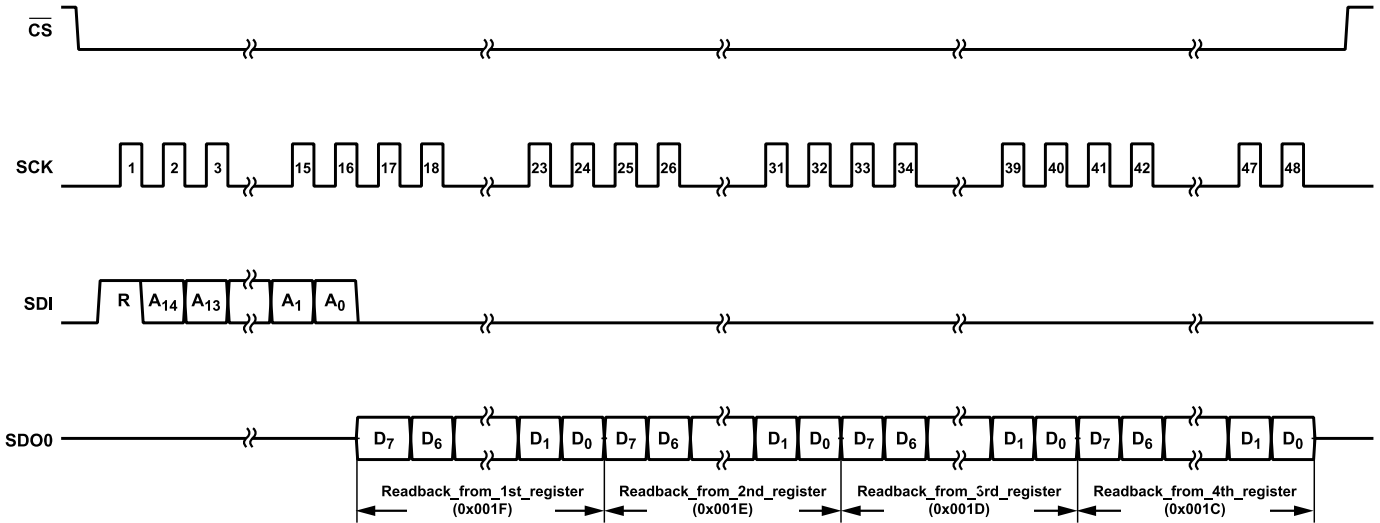

Figure 51. Stream Mode Bulk Register Read Back Operation

SERIAL INTERFACE

SAMPLE CONVERSION TIMING AND DATA TRANSFER

A conversion is started on the rising edge of the CNV signal, as shown in Figure 52. Once the conversion is complete, CS can be asserted, which causes the current conversion result to be loaded into the output shift register.

Referring to Figure 52, there are two optional data transfer zones for sample N. Zone 1 represents the use case where CS is asserted immediately following the de-assertion of BUSY signal for the sample N conversion (in SPI conversion mode), or after 300 ns for echo and host clock modes. For Zone 1, the available time to read out sample N is given by the following:

$$\text{Zone 1 Data Read Window} = t_{CYC} - t_{CONV} - t_{QUIET_CNV_ADV}$$

For example, if f_{CNV} is 2 MSPS ($t_{CYC} = 500 \text{ ns}$) and using the typical value of t_{CONV} (282 ns), the available window width is 198.4 ns (= $500 \text{ ns} - 282 \text{ ns} - 19.6 \text{ ns}$).

Zone 2 represents the case where assertion of CS to read Sample N is delayed until after the conversion for Sample N + 1 is initiated.

To prevent data corruption, a quiet zone must be observed before and after each rising edge of the CNV signal, as shown in Figure 52. The quiet zone immediately before the rising edge of CNV is $t_{QUIET_CNV_ADV}$ and is equal to 19.6 ns. The quiet zone immediately after the rising edge of CNV is $t_{QUIET_CNV_DELAY}$ and is equal to 9.8 ns. Assuming that the CS is asserted immediately after the quiet zone around the rising edge of CNV, the amount of time available to clock out the data is the following:

$$\text{Zone 2 Data Read Window} = t_{CYC} - t_{QUIET_CNV_DELAY} - t_{QUIET_CNV_ADV}$$

For example, if f_{CNV} is 2 MSPS ($t_{CYC} = 500 \text{ ns}$) and using the typical value of t_{CONV} (282 ns), the available window width is 470.6 ns (= $500 \text{ ns} - 9.8 \text{ ns} - 19.6 \text{ ns}$). The Zone 2 transfer window is longer than the Zone 1 window, which can enable the use of a slower SCK on the SPI and ease the timing requirements for the interface. When using Zone 2 for the data transfer, it is recommended to assert CS immediately after the quiet zone. However, Zone 2 must be asserted at least 25 ns before the falling edge of BUSY for Sample N + 1. If not, Sample N is overwritten with Sample N + 1.

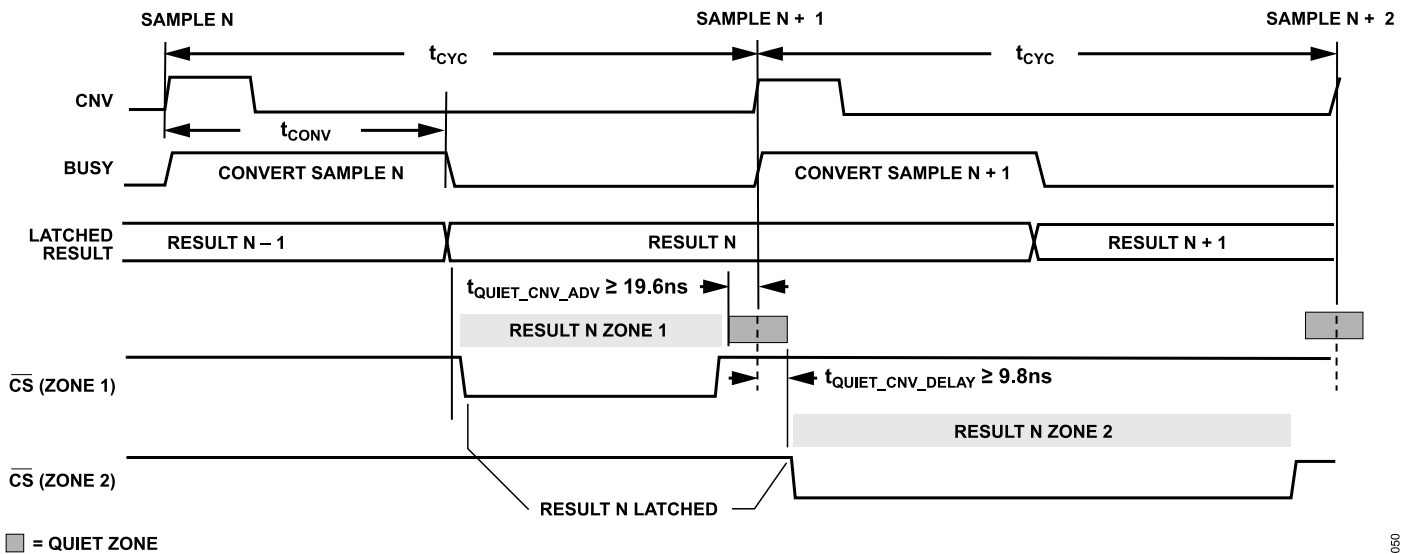

Figure 52. Example Timing for Data Transfer Zones

SERIAL INTERFACE

CLOCKING MODES

This section covers the various clocking modes supported by the AD4030-24/AD4032-24 SPI. These modes are available for 1-lane, 2-lanes, and 4-lanes. The clocking mode is configured in the modes register (see [Table 16](#) for register descriptions).

SPI Clocking Mode

SPI clocking mode is the default clocking mode of the AD4030-24/AD4032-24 and is equivalent to a host-sourced bit clock (SCK), in which the host controller uses its own clock to latch the output data. The SPI-compatible clocking mode is enabled by writing 0x0 to the CLK_MD bit field of the modes register (see the [Modes](#)

[Register](#) section). The interface connection is as shown in [Figure 50](#). In this mode, the BUSY_SCKOUT pin signal is valid and indicates the completion of a conversion (high to low transition of the BUSY_SCKOUT pin). A simplified sample cycle is shown in [Figure 53](#). When not in averaging mode, if the host controller does not use the BUSY_SCKOUT pin signal to detect the completion of a conversion and instead uses an internal timer to retrieve the data, the host controller must wait at least 300 ns after the rising edge of the CNV pulse before asserting \overline{CS} low. When operating in block averaging mode, the host controller must assert \overline{CS} low no sooner than 300 ns after the rising edge of the CNV pulse for the last sample in the block.

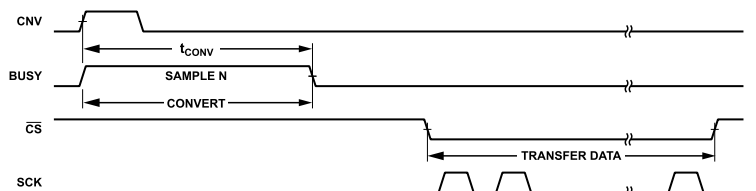

Figure 53. Typical Sample Cycle for SPI Clocking Mode

SERIAL INTERFACE

Echo Clock Mode

Figure 54 shows the signal connections for the echo clock mode. The echo clock mode is enabled by writing 0x1 to the CLK_MD bit field of the modes register (see the [Modes Register](#) section). In this mode, the BUSY_SCKOUT pin cannot be used to detect a conversion completion. The BUSY_SCKOUT pin becomes a bit clock output and is sourced by looping through the SCK of the host controller to the BUSY_SCKOUT pin (with some fixed delay, 5.4 ns to 7.9 ns, depending on the voltage of the VIO pins). To begin retrieving the conversion data in nonaveraging mode, the host controller must assert \overline{CS} low no sooner than 300 ns after the rising edge of the CNV pulse. When the ADC is configured for block averaging mode, the host controller must assert \overline{CS} low no sooner than 300 ns after the rising edge of the CNV pulse for the last sample in the block. Example timing diagrams are shown in the [Data Cloning Requirements and Timing](#) section. When echo clock mode is enabled, the BUSY_SCKOUT pin is aligned with the SDOx pins transitions, making the data and clock timing insensitive to asymmetric propagation delays in the paths of the SDOx pins and SCK pins.

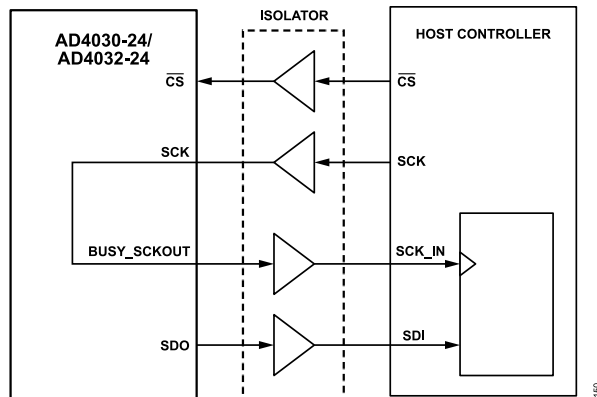

Figure 54. Echo Clock Mode Signal Path Diagram

Host Clock Mode

When enabled, host clock mode uses the internal oscillator as the bit clock source. The host clock mode is enabled by writing 0x2 to the CLK_MD bit field of the modes register. The bit clock frequency can be programmed in the OSC_DIV bit field in the internal oscillator register, with available divisor values of 1, 2, or 4 (see the [Internal Oscillator Register](#) section). Figure 55 shows the signal connections for the host clock mode. In this mode, the BUSY_SCKOUT pin provides the bit clock output and cannot be used to detect a conversion completion. The AD4030-24/AD4032-24 automatically calculate the number of clock pulses required to clock out the conversion data based on word size, number of active lanes, and choice of single data rate mode or dual data rate mode. The number of clock pulses can be read from the OSC_LIMIT bit field of the internal oscillator register. The SCK_IN from the host must not be active. When retrieving the conversion data in nonaveraging mode, the host must not assert \overline{CS} low sooner than 300 ns after

the rising edge of the CNV pulse. When the ADC is configured in averaging mode for 2^N averages, the host must not assert \overline{CS} low sooner than 300 ns after the rising edge of the CNV pulse for the last sample in the block.

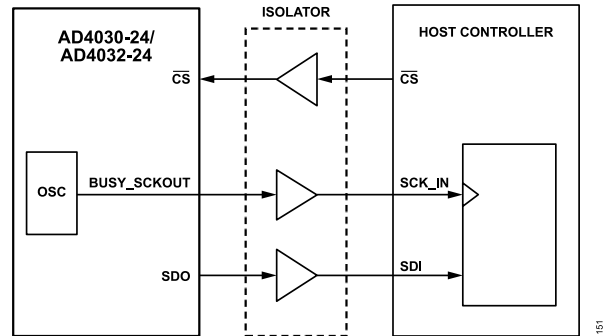

Figure 55. Host Clock Mode Signal Path Example

Single Data Rate

Single data rate clocking (SDR), in which one bit (per active lane) is clocked out during a single clock cycle, is supported for all output configurations and sample formats (see [Table 14](#)). The SDR clocking mode is enabled by default at power-up or can be enabled by writing 0 to the DDR_MD bit of the modes register (see the [Modes Register](#) section).

Dual Data Rate

Dual data rate (DDR) mode (two data bit transitions per clock cycle per active lane) is available only for host clock mode and echo clock mode.

The DDR clocking mode is enabled by writing 1 to the DDR_MD bit of the modes register (see the [Modes Register](#) section). The DDR mode uses half the number of SCK pulses to clock out conversion data in comparison to SDR mode.

1-Lane Output Data Cloning Mode

1-lane is the default output data cloning mode at power-up. The 1-lane output data cloning mode is enabled by writing 0x0 to the LANE_MD bit of the modes register (see the [Modes Register](#) section). The active lane is SDO0. Example timing diagrams for 1-lane mode using SPI clocking mode, echo clock mode, and host clock mode are in the [Data Cloning Requirements and Timing](#) section.

2-Lane Output Data Cloning Mode

When 2-lane output data cloning mode is enabled, the sample word bits are split between two SDO lanes. Figure 58 shows how the bits are allocated between the lanes for 2-lane mode. The bit arrangement is the same for SPI clock mode, echo clock mode, and host clock mode. 2-lane output data cloning mode is enabled by writing 0x1 to the LANE_MD bit of the modes register (see

SERIAL INTERFACE

the [Modes Register](#) section). The host controller must recombine the data coming from the SDO lanes to reconstruct the original sample word. The number of SCK pulses required to clock out the conversion data is reduced by one-half with respect to the 1-lane mode. [Table 14](#) lists the active SDO lanes for 2-lane mode. Example timing diagrams for 2-lane mode using SPI clock mode, echo clock mode, and host clock mode are in the [Data Clocking Requirements and Timing](#) section.

4-Lane Output Data Clocking Mode

When 4-lane output data clocking mode is enabled, the sample word bits are split between four SDO lanes. [Figure 59](#) shows how the bits are allocated between the lanes for 4-lane mode. The bit arrangement is the same for SPI clock mode, echo clock mode,

and host clock mode. 4-lane output data clocking mode is enabled by writing 0x2 to the LANE_MD bit of the modes register (see the [Modes Register](#) section). The host controller must recombine the data coming from the SDO lanes to reconstruct the original sample word. The number of SCK pulses required to clock out the conversion data is reduced by one-fourth with respect to the 1-lane output data clocking. The active SDO lanes for 4-lane mode are shown in [Table 14](#). Example timing diagrams for 4-lane mode using SPI clock mode, echo clock mode, and host clock mode are in the [Data Clocking Requirements and Timing](#) section.

Data Output Modes Summary

[Table 14](#) is a summary of the supported data output modes of the AD4030-24/AD4032-24.

Table 14. AD4030-24/AD4032-24 Supported Data Output Modes

Number of Lanes	Active SDO Lanes	Clock Mode	Supported Data Clocking Mode	Output Sample Data-Word Length
1	SDO0	SPI	SDR only	24 or 32
		Echo	SDR and DDR	24 or 32
		Host	SDR and DDR	24 or 32
2	SDO0, SDO1	SPI	SDR only	24 or 32
		Echo	SDR and DDR	24 or 32
		Host	SDR and DDR	24 or 32
4	SDO0, SDO1, SDO2, SDO3	SPI	SDR only	24 or 32
		Echo	SDR and DDR	24 or 32
		Host	SDR and DDR	24 or 32

SERIAL INTERFACE

DATA CLOCKING REQUIREMENTS AND TIMING

Basic and Averaging Conversion Cycles

Figure 56 shows the basic conversion cycle for a single sample. This cycle applies to SPI clocking mode. When using echo clock mode and host clock mode, the BUSY_SCKOUT pin function is disabled and the bit clock is sourced on the BUSY_SCKOUT pin. The data transfer must meet the requirements described in the Sample Conversion Timing and Data Transfer section.

Table 15 contains the minimum and maximum values for the conversion timing parameters, which apply to all clocking modes.

Table 15. Conversion Cycle Timing Parameters

Parameter	Min	Max
t _{CNVH}	10 ns	No specific maximum
t _{CNVL}	20 ns	No specific maximum
t _{CONV}	264 ns	300 ns

The duration of the data transfer period is dependent on the sample resolution, number of active lanes, SCK frequency, and data clocking mode (SDR or DDR). The nominal value of the transfer duration is given by

$$\text{Data Transfer Duration} = t_{TRANS} = \frac{N_{BITS}}{M_{LANES}} \times \frac{1}{f_{SCK}} \times \frac{1}{K} \text{ seconds}$$

where:

N_{BITS} = number of bits to clock out

M_{LANES} = number of lanes used to clock out the data (1, 2, or 4)

f_{SCK} = SCK clock frequency, in Hz

K = 1 (SDR only, DDR not available for SPI mode clocking)

For a given f_{SCK}, number of data lanes, sample word size, and SDR/DDR mode, the minimum sample period when using Zone 1 for the data transfer is as follows:

Minimum Zone 1 Sample Period:

$$t_{CYC} \geq \left(\frac{N_{BITS}}{M_{LANES} \times f_{SCK} \times K} \right) + t_{CONV} + t_{QUIET_CNV_ADV}$$

The minimum sample period when using Zone 2 for data transfer is as follows:

$$t_{CYC} \geq \left(\frac{N_{BITS}}{M_{LANES} \times f_{SCK} \times K} \right) + t_{QUIET_CNV_DELAY} + t_{QUIET_CNV_ADV}$$

Figure 57 shows a typical conversion cycle when the averaging mode is active and SPI clocking mode is being used. The BUSY signal is asserted for a number of CNV clock periods that are equal to the configured number of samples to be averaged. The averaged sample is available when the BUSY signal is deasserted. Like nonaveraged mode, if the configured clocking mode is either echo clock or host clock, the BUSY signal is replaced by the output bit clock (SCKOUT). The host controller must manage the timing for asserting CS.

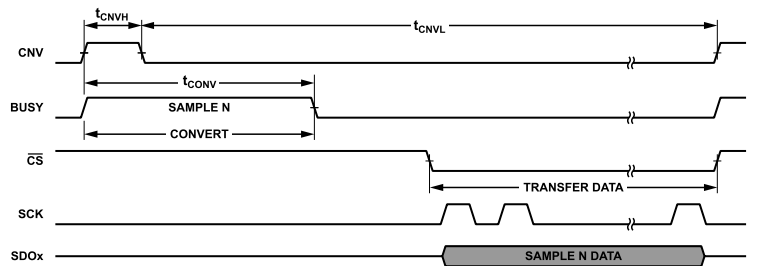

Figure 56. Basic Single Sample Conversion Cycle



Figure 57. Example Conversion Cycle for Averaging Mode

SERIAL INTERFACE

SPI Clocking Mode Timing Diagrams

1-Lane, SDR Mode

Figure 6 shows a conversion cycle for single lane data output, SDR mode (1-bit per clock cycle).

2-Lane, SDR Mode

Figure 58 shows a conversion cycle for 2-lane data output using SDR cllocking mode. See the [2-Lane Output Data Cllocking Mode](#) section for more information.

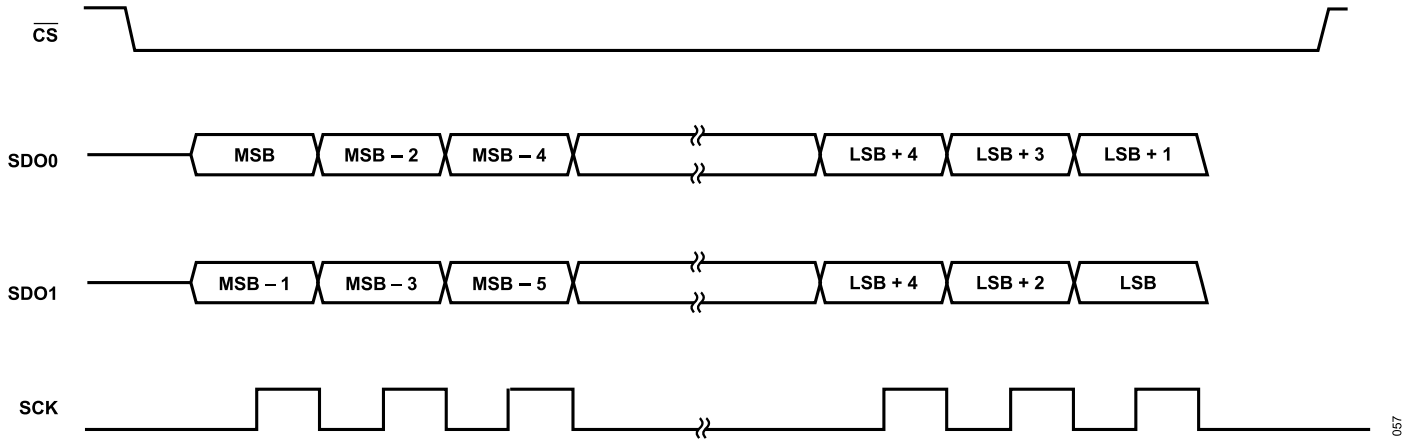

Figure 58. 2-Lane Mode, SDR Timing Diagram

SERIAL INTERFACE

4-Lane, SDR Mode

Figure 59 shows a conversion cycle for 4-lane data output using SDR clocking mode. See the [4-Lane Output Data Clocking Mode](#) section for more information.

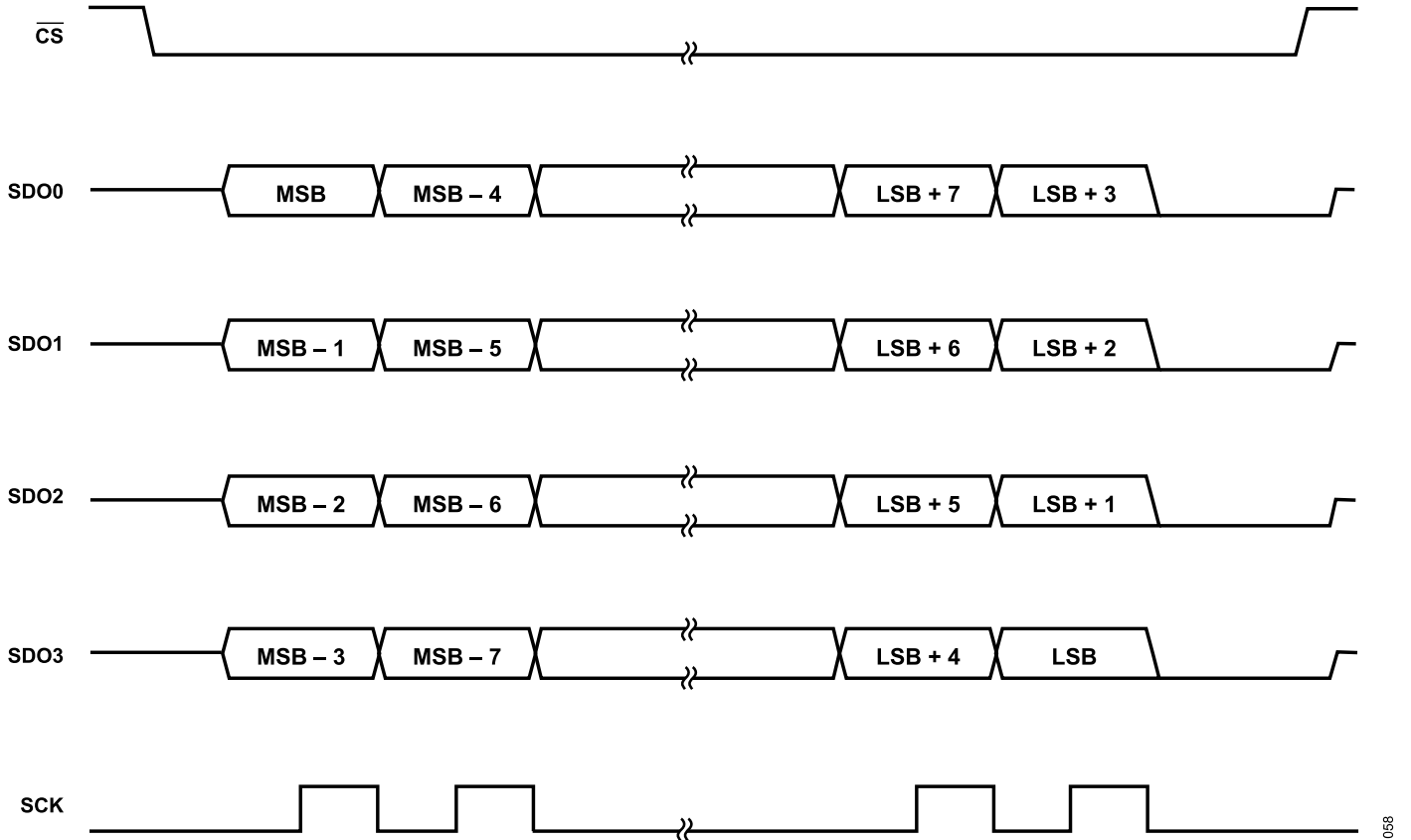

Figure 59. 4-Lane, SDR Timing Diagram

SERIAL INTERFACE

Echo Clock Timing Diagrams

1-Lane, SDR Mode, Echo Clock Mode

Figure 7 shows the timing relationships for SDR mode (1-bit per SCK period) in 1-lane echo clock mode. The timing relationships between the signals apply to both 24-bit and 32-bit sample word formats.

SCKOUT is a delayed version of the incoming SCK. The delay (t_{DSDO}) has a maximum value of 5.6 ns (at $V_{IO} > 1.71$ V). Changes in SDOx logic states are aligned to the rising edges of SCKOUT. The clock and data edge alignments are the same for 1-lane, 2-lane, and 4-lane output data modes.

1-Lane, DDR Mode, Echo Clock Mode

Figure 8 shows the timing relationships for DDR mode (2-bit transitions per SCKOUT period) in 1-lane mode echo clock mode. The timing relationships between the signals apply to both 24-bit and 32-bit sample word formats.

Similar to SDR mode, SCKOUT is a delayed version of the incoming SCK. Changes in SDOx logic states are aligned to both rising and falling edges of SCKOUT.

Host Clock Mode Timing

1-Lane, Host Clock Mode, SDR

Figure 9 shows the timing relationships for host clock mode when using SDR mode and 1-lane mode. Similar to echo clock mode, the clock rising edges are aligned to the data bit transitions. The frequency of SCKOUT signal is controlled by the OSC_DIV value programmed in the internal oscillator register (see the [Internal Oscillator Register](#) section).

1-Lane, Host Clock Mode, DDR

Figure 10 shows the timing relationships for host clock mode when using DDR. Similar to echo clock mode, the rising and falling clock edges are aligned to the data bit transitions. The frequency of SCKOUT signal is controlled by the OSC_DIV value programmed in the internal oscillator register (see the [Internal Oscillator Register](#) section).

LAYOUT GUIDELINES

The following layout guidelines are recommended to achieve maximum performance of the AD4030-24/AD4032-24:

- ▶ The AD4030-24/AD4032-24 contain internal 1 μF bypass capacitors for $\text{VDD}_{5\text{V}}$ and $\text{VDD}_{1.8\text{V}}$, and VIO contains an internal 0.2 μF capacitor. Therefore, no external bypass capacitors are required, which saves on board space, bill of materials count, and reduces layout sensitivity.
- ▶ It is recommended to have all the analog signals flow in from the left side of the AD4030-24/AD4032-24 and all the digital signals to flow in and out from the right side of the AD4030-24/AD4032-24 because this helps isolate analog signals from digital signals.
- ▶ Use a solid ground plane under the AD4030-24/AD4032-24 and connect all the analog ground (GND) pins and digital ground (IOGND) pins to the shared ground plane to avoid formation of ground loops.
- ▶ Traces routed to either the REFIN pin or REF pins must be isolated and shielded from other signals. Avoid routing signals beneath the reference trace (REFIN or REF). The REF pins are connected to an internal 2 μF capacitor, eliminating the need to place a decoupling capacitor on the output of the external reference buffer. If a noise reduction filter is placed between the output of the reference (or buffer) and the chosen reference input, it must be placed as close as possible to the AD4030-24/AD4032-24.

REGISTERS

The AD4030-24/AD4032-24 have programmable user registers that are used to configure the device. These registers can be accessed while the AD4030-24/AD4032-24 is in register configuration mode. Table 16 contains the complete list of the AD4030-24/AD4032-24 user registers and bit fields in the registers. The Register Details section contains details about the functions of each of the bit fields. The access mode specifies whether the register is comprised only of read-only bits (R) or a mix of read-only and read/write bits (R/W). Read-only bits cannot be overwritten by an SPI write transaction, but read/write bits can.

Table 16. AD4030-24/AD4032-24 Register Summary

Reg	Name	Bits	Bit 7	Bit 6	Bit 5	Bit 4	Bit 3	Bit 2	Bit 1	Bit 0	Reset	R/W
0x00	INTERFACE_CONFIG_A	[7:0]	SW_RESET	RESERVED	ADDR_ASC ENSION	SDO_EN ABLE	RESERVED		SW_RES ETX	0x10	R/W	
0x01	INTERFACE_CONFIG_B	[7:0]	SINGLE_INST	STALLING	RESERVED		SHORT_INST RUCTION	RESERVED		0x00	R/W	
0x02	DEVICE_CONFIG	[7:0]	RESERVED						OPERATING_MO DES		0x00	R/W
0x03	CHIP_TYPE	[7:0]	RESERVED				CHIP_TYPE				0x07	R
0x04	PRODUCT_ID_L	[7:0]	PRODUCT_ID[7:0]								0x00	R
0x05	PRODUCT_ID_H	[7:0]	PRODUCT_ID[15:8]								0x20	R
0x06	CHIP_GRADE	[7:0]	GRADE				DEVICE_REVISION				0x00	R
0x0A	SCRATCH_PAD	[7:0]	SCRATCH_VALUE								0x00	R/W
0x0B	SPI_REVISION	[7:0]	SPI_TYPE		VERSION						0x81	R
0x0C	VENDOR_L	[7:0]	VID[7:0]								0x56	R
0x0D	VENDOR_H	[7:0]	VID[15:8]								0x04	R
0x0E	STREAM_MODE	[7:0]	LOOP_COUNT								0x00	R/W
0x11	INTERFACE_STATUS_A	[7:0]	RESERVED		CLOCK_C OUNT_ER R	RESERVED				0x00	R/W	
0x14	EXIT_CFG_MD	[7:0]	RESERVED						EXIT_CO NFIG_MD		0x00	R/W
0x15	AVG	[7:0]	AVG_SYNC	RESERVED		AVG_VAL				0x00	R/W	
0x16	OFFSET_LB	[7:0]	USER_OFFSET[7:0]								0x00	R/W
0x17	OFFSET_MB	[7:0]	USER_OFFSET[15:8]								0x00	R/W
0x18	OFFSET_HB	[7:0]	USER_OFFSET[23:16]								0x00	R/W
0x19	UNUSED1_LB	[7:0]	UNUSED1[7:0]								0x00	R/W
0x1A	UNUSED1_MB	[7:0]	UNUSED1[15:8]								0x00	R/W
0x1B	UNUSED1_HB	[7:0]	UNUSED1[23:16]								0x00	R/W
0x1C	GAIN_LB	[7:0]	USER_GAIN[7:0]								0x00	R/W
0x1D	GAIN_HB	[7:0]	USER_GAIN[15:8]								0x80	R/W
0x1E	UNUSED2_LB	[7:0]	UNUSED2[7:0]								0x00	R/W
0x1F	UNUSED2_HB	[7:0]	UNUSED2[15:8]								0x80	R/W
0x20	MODES	[7:0]	LANE_MD		CLK_MD		DDR_MD	OUT_DATA_MD			0x00	R/W
0x21	OSCILLATOR	[7:0]	OSC_LIMIT				OSC_DIV				0x00	R/W
0x22	IO	[7:0]	RESERVED						IO2X		0x00	R/W
0x23	TEST_PAT_BYTE0	[7:0]	TEST_DATA_PAT[7:0]								0x0F	R/W
0x24	TEST_PAT_BYTE1	[7:0]	TEST_DATA_PAT[15:8]								0x0F	R/W
0x25	TEST_PAT_BYTE2	[7:0]	TEST_DATA_PAT[23:16]								0x5A	R/W
0x26	TEST_PAT_BYTE3	[7:0]	TEST_DATA_PAT[31:24]								0x5A	R/W
0x34	DIG_DIAG	[7:0]	POWERUP_CO MPLETED	RESET_OC CURRED	RESERVED				FUSE_CR C_EN		0x40	R/W
0x35	DIG_ERR	[7:0]	RESERVED						FUSE_CR C_ERR		0x00	R/W

REGISTER DETAILS

INTERFACE CONFIGURATION A REGISTER

Address: 0x00, Reset: 0x10, Name: INTERFACE_CONFIG_A

Interface configuration settings.

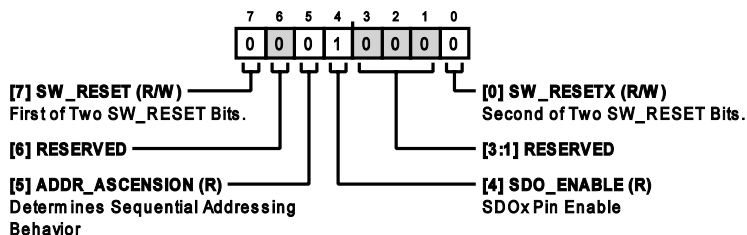

Table 17. Bit Descriptions for INTERFACE_CONFIG_A

Bits	Bit Name	Description	Reset	Access
7	SW_RESET	First of Two SW_RESET Bits. This bit appears in two locations in this register. Both locations must be written at the same time to trigger a software reset of the device. All registers except for this register are reset to their default values.	0x0	R/W
6	RESERVED	Reserved.	0x0	R
5	ADDR_ASCENSION	Determines Sequential Addressing Behavior. 0: address accessed is decremented by one for each data byte when streaming. 1: not a valid option.	0x0	R
4	SDO_ENABLE	SDOx Pin Enable.	0x1	R
[3:1]	RESERVED	Reserved.	0x0	R
0	SW_RESETX	Second of Two SW_RESET Bits. This bit appears in two locations in this register. Both locations must be written at the same time to trigger a software reset of the device. All registers except for this register are reset to their default values.	0x0	R/W

INTERFACE CONFIGURATION B REGISTER

Address: 0x01, Reset: 0x00, Name: INTERFACE_CONFIG_B

Additional interface configuration settings.

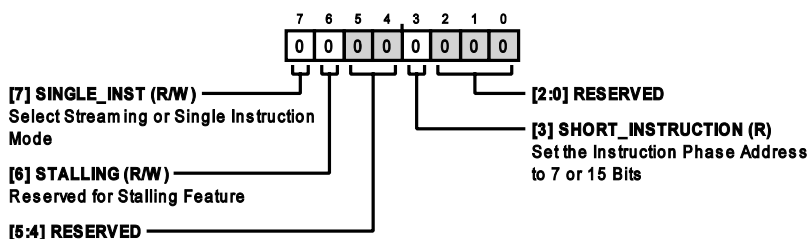

Table 18. Bit Descriptions for INTERFACE_CONFIG_B

Bits	Bit Name	Description	Reset	Access
7	SINGLE_INST	Select Streaming or Single Instruction Mode. 0: streaming mode is enabled. The address decrements as successive data bytes are received. 1: single instruction mode is enabled.	0x0	R/W
6	STALLING	Reserved for Stalling Feature.	0x0	R/W
[5:4]	RESERVED	Reserved.	0x0	R
3	SHORT_INSTRUCTION	Set the Instruction Phase Address to 7 Bits or 15 Bits. 0: 15-bit addressing. 1: 7-bit addressing.	0x0	R

REGISTER DETAILS

Table 18. Bit Descriptions for INTERFACE_CONFIG_B

Bits	Bit Name	Description	Reset	Access
[2:0]	RESERVED	Reserved.	0x0	R

DEVICE CONFIGURATION REGISTER

Address: 0x02, Reset: 0x00, Name: DEVICE_CONFIG

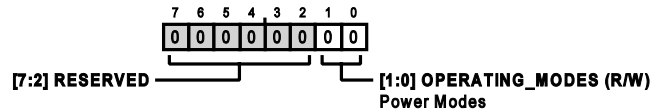

Table 19. Bit Descriptions for DEVICE_CONFIG

Bits	Bit Name	Description	Reset	Access
[7:2]	RESERVED	Reserved.	0x0	R
[1:0]	OPERATING_MODES	Power Modes 00: normal operating mode. 11: shutdown mode.	0x0	R/W

CHIP TYPE REGISTER

Address: 0x03, Reset: 0x07, Name: CHIP_TYPE

The chip type is used to identify the family of Analog Devices products a given device belongs to. Use the chip type with the product ID to uniquely identify a given product.

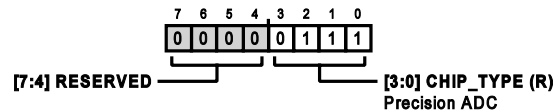

Table 20. Bit Descriptions for CHIP_TYPE

Bits	Bit Name	Description	Reset	Access
[7:4]	RESERVED	Reserved.	0x0	R
[3:0]	CHIP_TYPE	Precision ADC.	0x7	R

PRODUCT ID LOW REGISTER

Address: 0x04, Reset: 0x00, Name: PRODUCT_ID_L

Low byte of the product ID.

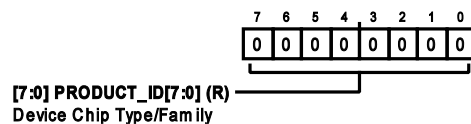

Table 21. Bit Descriptions for PRODUCT_ID_L

Bits	Bit Name	Description	Reset	Access
[7:0]	PRODUCT_ID[7:0]	Device Chip Type/Family. Use the product ID with the chip type to identify a product.	0x0	R

PRODUCT ID HIGH REGISTER

Address: 0x05, Reset: 0x20, Name: PRODUCT_ID_H

High byte of the product ID.

REGISTER DETAILS

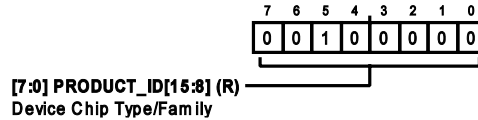

Table 22. Bit Descriptions for PRODUCT_ID_H

Bits	Bit Name	Description	Reset	Access
[7:0]	PRODUCT_ID[15:8]	Device Chip Type/Family. Use the product ID with the chip type to identify a product.	0x20	R

CHIP GRADE REGISTER

Address: 0x06, Reset: 0x81, Name: CHIP_GRADE

Identifies product variations and device revisions.

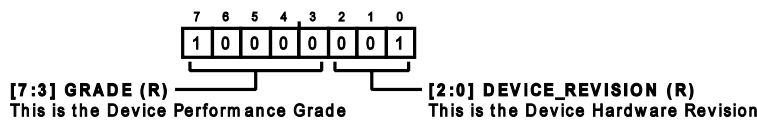

Table 23. Bit Descriptions for CHIP_GRADE

Bits	Bit Name	Description	Reset	Access
[7:3]	GRADE	This is the Device Performance Grade.		
		AD4030-24: 0b10000.	0x10	R
		AD4032-24: 0b10010.	0x12	R
[2:0]	DEVICE_REVISION	This is the Device Hardware Revision.	0x1	R

SCRATCH PAD REGISTER

Address: 0x0A, Reset: 0x00, Name: SCRATCH_PAD

This register can be used to test writes and reads.

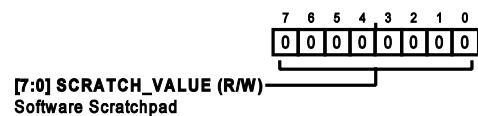

Table 24. Bit Descriptions for SCRATCH_PAD

Bits	Bit Name	Description	Reset	Access
[7:0]	SCRATCH_VALUE	Software Scratchpad. Software can write to and read from this location without any device side effects.	0x0	R/W

SPI REVISION REGISTER

Address: 0x0B, Reset: 0x81, Name: SPI_REVISION

Indicates the SPI revision.

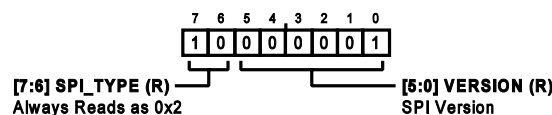

Table 25. Bit Descriptions for SPI_REVISION

Bits	Bit Name	Description	Reset	Access
[7:6]	SPI_TYPE	Always Reads as 0x2.	0x2	R

REGISTER DETAILS

Table 25. Bit Descriptions for SPI_REVISION

Bits	Bit Name	Description	Reset	Access
[5:0]	VERSION	SPI Version.	0x1	R

VENDOR ID LOW REGISTER

Address: 0x0C, Reset: 0x56, Name: VENDOR_L

Low byte of the vendor ID.

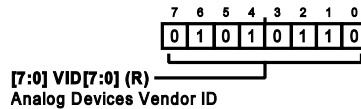

Table 26. Bit Descriptions for VENDOR_L

Bits	Bit Name	Description	Reset	Access
[7:0]	VID[7:0]	Analog Devices Vendor ID.	0x56	R

VENDOR ID HIGH REGISTER

Address: 0x0D, Reset: 0x04, Name: VENDOR_H

High byte of the vendor ID.

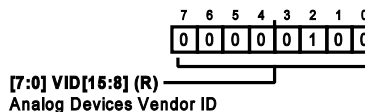

Table 27. Bit Descriptions for VENDOR_H

Bits	Bit Name	Description	Reset	Access
[7:0]	VID[15:8]	Analog Devices Vendor ID.	0x4	R

STREAM MODE REGISTER

Address: 0x0E, Reset: 0x00, Name: STREAM_MODE

Defines the length of the loop when streaming data.

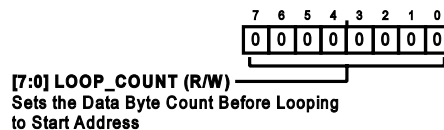

Table 28. Bit Descriptions for STREAM_MODE

Bits	Bit Name	Description	Reset	Access
[7:0]	LOOP_COUNT	Sets the Data Byte Count Before Looping to Start Address. Not enabled in the AD4030-24.	0x0	R/W

INTERFACE STATUS A REGISTER

Address: 0x11, Reset: 0x00, Name: INTERFACE_STATUS_A

Status bits are set to 1 to indicate an active condition. The status bits can be cleared by writing a 1 to the corresponding bit location.

REGISTER DETAILS

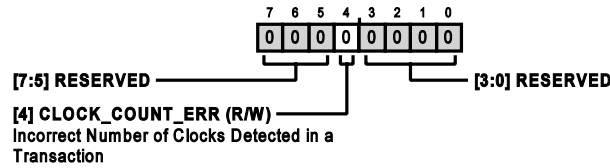

Table 29. Bit Descriptions for INTERFACE_STATUS_A

Bits	Bit Name	Description	Reset	Access
[7:5]	RESERVED	Reserved.	0x0	R
4	CLOCK_COUNT_ERR	Incorrect Number of Clocks Detected in a Transaction. 0 = no error. 1 = incorrect number of clocks detected in a transaction. Write 1 to clear.	0x0	R/W1C
[3:0]	RESERVED	Reserved.	0x0	R

EXIT CONFIGURATION MODE REGISTER

Address: 0x14, Reset: 0x00, Name: EXIT_CFG_MD

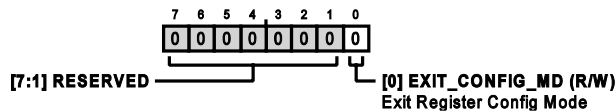

Table 30. Bit Descriptions for EXIT_CFG_MD

Bits	Bit Name	Description	Reset	Access
[7:1]	RESERVED	Reserved.	0x0	R
0	EXIT_CONFIG_MD	Exit Register Config Mode. Write 1 to exit register configuration mode. Self clearing upon $\overline{CS} = 1$.	0x0	R/W

AVERAGING MODE REGISTER

Address: 0x15, Reset: 0x00, Name: AVG

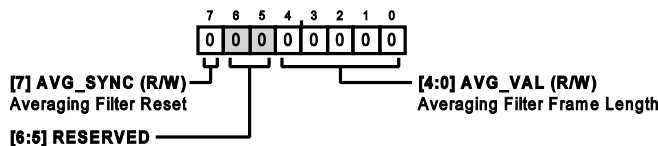

Table 31. Bit Descriptions for AVG

Bits	Bit Name	Description	Reset	Access
7	AVG_SYNC	Averaging Filter Reset. 1 = reset, self clearing.	0x0	R/W
[6:5]	RESERVED	Reserved.	0x0	R
[4:0]	AVG_VAL	Averaging Filter Block Length, 2^N . 0x00 = no averaging. 0x01 = 2^1 samples. 0x02 = 2^2 samples. 0x03 = 2^3 samples. 0x04 = 2^4 samples. 0x05 = 2^5 samples. ... 0x0F = 2^{15} samples. 0x10 = 2^{16} samples. 0x11 through 0x1F = invalid.	0x0	R/W

REGISTER DETAILS

OFFSET REGISTERS

Address: 0x16, Reset: 0x00, Name: OFFSET_LB

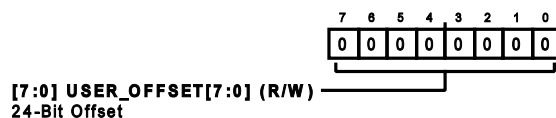

Table 32. Bit Descriptions for OFFSET_LB

Bits	Bit Name	Description	Reset	Access
[7:0]	USER_OFFSET[7:0]	24-Bit Offset. Twos complement (signed). $1 \text{ LSB} = \frac{V_{REF}}{2^{23}}/GAIN.$	0x0	R/W

Address: 0x17, Reset: 0x00, Name: OFFSET_MB

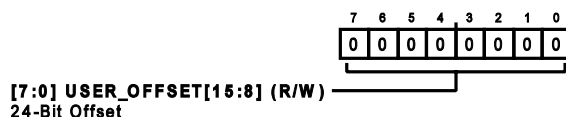

Table 33. Bit Descriptions for OFFSET_MB

Bits	Bit Name	Description	Reset	Access
[7:0]	USER_OFFSET[15:8]	24-Bit Offset. Twos complement (signed). $1 \text{ LSB} = \frac{V_{REF}}{2^{23}}/GAIN.$	0x0	R/W

Address: 0x18, Reset: 0x00, Name: OFFSET_HB

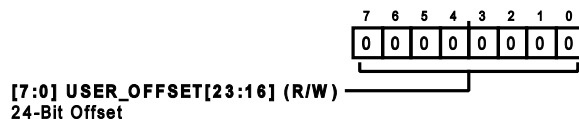

Table 34. Bit Descriptions for OFFSET_HB

Bits	Bit Name	Description	Reset	Access
[7:0]	USER_OFFSET[23:16]	24-Bit Offset. Twos complement (signed). $1 \text{ LSB} = \frac{V_{REF}}{2^{23}}/GAIN.$	0x0	R/W

GAIN REGISTERS

Address: 0x1C, Reset: 0x00, Name: GAIN_LB

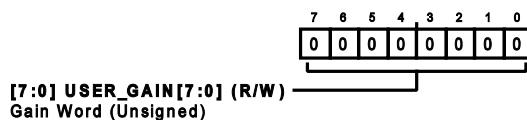

Table 35. Bit Descriptions for GAIN_LB

Bits	Bit Name	Description	Reset	Access
[7:0]	USER_GAIN[7:0]	Gain Word (Unsigned). Multiplier Output = Input × Gain Word/0x8000. Maximum Effective Gain = 0xFFFF/0x8000 = 1.99997.	0x0	R/W

Address: 0x1D, Reset: 0x80, Name: GAIN_HB

REGISTER DETAILS

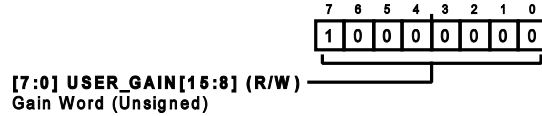

Table 36. Bit Descriptions for GAIN_HB

Bits	Bit Name	Description	Reset	Access
[7:0]	USER_GAIN[15:8]	Gain Word (Unsigned). Multiplier Output = Input × Gain Word/0x8000. Maximum Effective Gain = 0xFFFF/0x8000 = 1.99997.	0x80	R/W

MODES REGISTER

Address: 0x20, Reset: 0x00, Name: MODES

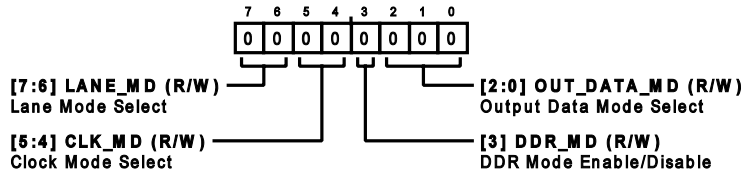
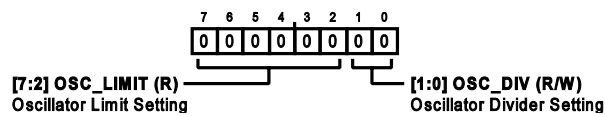

Table 37. Bit Descriptions for MODES

Bits	Bit Name	Description	Reset	Access
[7:6]	LANE_MD	Lane Mode Select. 00 = one lane. 01 = two lanes. 10 = four lanes. 11 = invalid setting.	0x0	R/W
[5:4]	CLK_MD	Clock Mode Select. 00 = SPI clocking mode. 01 = echo clock mode. 10 = host clock mode. 11 = invalid setting.	0x0	R/W
3	DDR_MD	DDR Mode Enable/Disable. 0 = SDR. 1 = DDR (only valid for echo clock mode and host clock mode).	0x0	R/W
[2:0]	OUT_DATA_MD	Output Data Mode Select. 000 = 24-bit differential data. 001 = 16-bit differential data + 8-bit common-mode data. 010 = 24-bit differential data + 8-bit common-mode data. 011 = 30-bit averaged differential data + OR bit + SYNC bit. 100 = 32-bit test data pattern (TEST_DATA_PAT).	0x0	R/W

INTERNAL OSCILLATOR REGISTER

Address: 0x21, Reset: 0x00, Name: OSCILLATOR



REGISTER DETAILS

Table 38. Bit Descriptions for OSCILLATOR

Bits	Bit Name	Description	Reset	Access
[7:2]	OSC_LIMIT	Oscillator Limit Setting. Oscillator is limited to this number of clock pulses plus one. Automatically calculated by the AD4030-24 based on the data-word size, number of active SDO lanes, and data rate mode (SDR or DDR).	0x0	R
[1:0]	OSC_DIV	Oscillator Divider Setting. 00 = no divide (divide by 1). 01 = divide by 2. 10 = divide by 4. 11 = invalid setting.	0x0	R/W

OUTPUT DRIVER REGISTER

Address: 0x22, Reset: 0x00, Name: IO

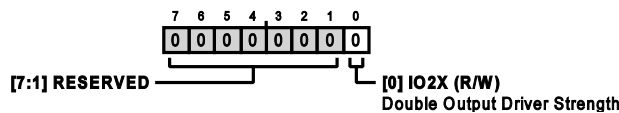

Table 39. Bit Descriptions for IO

Bits	Bit Name	Description	Reset	Access
[7:1]	RESERVED	Reserved.	0x0	R
0	IO2X	Double Output Driver Strength. 1 = double output driver strength. 0 = normal output driver strength.	0x0	R/W

TEST PATTERN REGISTERS

Address: 0x23, Reset: 0x0F, Name: TEST_PAT_BYTE0

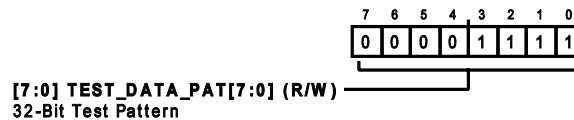

Table 40. Bit Descriptions for TEST_PAT_BYTE0

Bits	Bit Name	Description	Reset	Access
[7:0]	TEST_DATA_PAT[7:0]	32-Bit Test Pattern. Applied when OUT_DATA_MD = 4.	0xF	R/W

Address: 0x24, Reset: 0x0F, Name: TEST_PAT_BYTE1



Table 41. Bit Descriptions for TEST_PAT_BYTE1

Bits	Bit Name	Description	Reset	Access
[7:0]	TEST_DATA_PAT[15:8]	32-Bit Test Pattern. Applied when OUT_DATA_MD = 4.	0xF	R/W

Address: 0x25, Reset: 0x5A, Name: TEST_PAT_BYTE2

REGISTER DETAILS

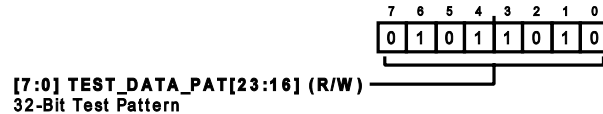

Table 42. Bit Descriptions for TEST_PAT_BYTE2

Bits	Bit Name	Description	Reset	Access
[7:0]	TEST_DATA_PAT[23:16]	32-Bit Test Pattern. Applied when OUT_DATA_MD = 4.	0x5A	R/W

Address: 0x26, Reset: 0x5A, Name: TEST_PAT_BYTE3

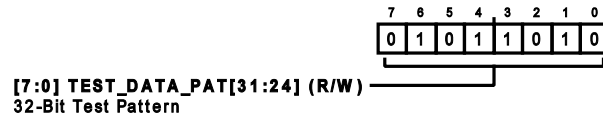

Table 43. Bit Descriptions for TEST_PAT_BYTE3

Bits	Bit Name	Description	Reset	Access
[7:0]	TEST_DATA_PAT[31:24]	32-Bit Test Pattern. Applied when OUT_DATA_MD = 4.	0x5A	R/W

DIGITAL DIAGNOSTICS REGISTER

Address: 0x34, Reset: 0x40, Name: DIG_DIAG

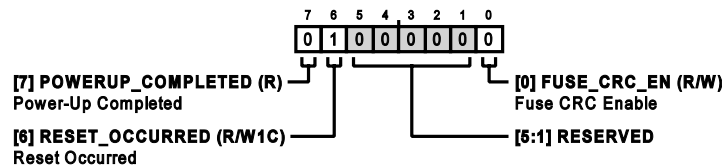

Table 44. Bit Descriptions for DIG_DIAG

Bits	Bit Name	Description	Reset	Access
7	POWERUP_COMPLETED	Power-Up Completed. 1 = power-up completed. Self clearing.	0x0	R
6	RESET_OCCURRED	Reset Occurred. This bit is set to 1 upon a reset event. Write 1 to clear (useful for detecting brownouts).	0x1	R/W1C
[5:1]	RESERVED	Reserved.	0x0	R
0	FUSE_CRC_EN	Fuse CRC Enable. Write a 1 to force recheck of CRC.	0x0	R/W

DIGITAL ERRORS REGISTER

Address: 0x35, Reset: 0x00, Name: DIG_ERR

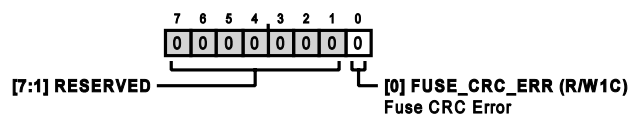

Table 45. Bit Descriptions for DIG_ERR

Bits	Bit Name	Description	Reset	Access
[7:1]	RESERVED	Reserved.	0x0	R
0	FUSE_CRC_ERR	Fuse CRC Error. This bit is set to 1 upon a fuse CRC error. Write 1 to clear.	0x0	R/W1C