

0.5 Ω R_{ON} , ± 15 V, +12 V, ± 5 V, +5 V/–12 V, Quad SPST Switch

FEATURES

- ▶ Low R_{ON} 0.5 Ω
- ▶ High continuous current of up to 847 mA
- ▶ Flat R_{ON} across signal range, 0.003 Ω
- ▶ THD of –122 dB at 1 kHz
- ▶ Improved balance between on resistance and on capacitance
 - ▶ Low R_{ON} (0.5 Ω) and C_{ON} (28 pF)
- ▶ 1.8 V, 3.3 V, and 5 V Logic compatibility
- ▶ 16-lead, 4 mm x 4 mm LFCSP
 - ▶ Pin to pin compatible with the [ADG1412](#)
- ▶ Fully specified at ± 15 V, +12 V, ± 5 V and +5 V, –12 V
- ▶ Operational with asymmetric power supplies
- ▶ V_{SS} to $V_{DD} - 2$ V analog signal range

APPLICATIONS

- ▶ Automatic test equipment
- ▶ Data acquisition
- ▶ Instrumentation
- ▶ Avionics
- ▶ Audio and video switching
- ▶ Communication systems
- ▶ Relay replacement

GENERAL DESCRIPTION

The ADG2412 contains four independent single-pole/single-throw (SPST) switches. The ADG2412 switches turn on with logic 1 on the digital control inputs. Each switch conducts equally well in both directions when on, and each switch has an input signal range that extends from V_{SS} to $V_{DD} - 2$ V. When switches are open, signal levels up to the supplies are blocked.

The digital inputs are compatible with 5 V, 3.3 V, and 1.8 V logic inputs without the requirement for a separate digital logic supply pin.

The on-resistance profile is exceptionally flat over the full-analog input range, which ensures good linearity and low distortion when switching audio signals.

FUNCTIONAL BLOCK DIAGRAM

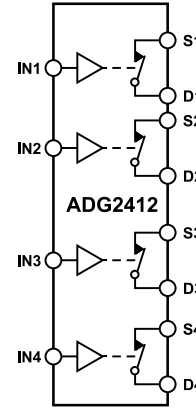

SWITCHES SHOWN FOR A LOGIC 1 INPUT. 

Figure 1. Functional Block Diagram

PRODUCT HIGHLIGHTS

1. Low R_{ON} of 0.5 Ω .
2. High continuous current carrying capability, see [Table 5](#) to [Table 8](#).
3. Dual-supply operation. For applications where the analog signal is bipolar, the ADG2412 can be operated from dual supplies up to ± 16.5 V.
4. Single-supply operation. For applications where the analog signal is unipolar, the ADG2412 can be operated from a single rail power supply up to 16.5 V.
5. 1.8 V logic-compatible digital inputs: $V_{INH} = 1.3$ V, $V_{INL} = 0.8$ V.
6. No V_L logic power supply required.

TABLE OF CONTENTS

Features.....	1	V_{INH}	18
Applications.....	1	I_{INL} and I_{INH}	18
General Description.....	1	C_S (Off) and C_D (Off).....	18
Functional Block Diagram.....	1	C_D (On) and C_S (On).....	18
Product Highlights.....	1	C_{IN}	18
Specifications.....	3	t_{ON}	18
Operating Supply Voltages.....	3	t_{OFF}	18
± 15 V Dual Supply.....	3	t_D	18
12 V Single Supply.....	4	Off Isolation.....	18
Dual and Asymmetric Supply.....	6	Charge Injection.....	18
Continuous Current Per Channel, Sx or Dx.....	7	Channel-to-Channel Crosstalk.....	18
Absolute Maximum Ratings.....	9	Bandwidth.....	18
Thermal Resistance.....	9	On Response.....	18
Electrostatic Discharge (ESD) Ratings.....	9	Insertion Loss.....	18
ESD Caution.....	9	Total Harmonic Distortion + Noise (THD + N)..	18
Pin Configuration and Function Descriptions.....	10	AC Power Supply Rejection Ratio (AC	
Typical Performance Characteristics.....	11	PSRR).....	18
Test Circuits.....	16	Theory of Operations.....	19
Terminology.....	18	Switch Architecture.....	19
I_{DD}	18	1.8 V Logic Compatibility.....	19
I_{SS}	18	Applications Information.....	20
V_D and V_S	18	Large Voltage, High Frequency Signal	
V_{TRACK}	18	Tracking.....	20
R_{ON}	18	Power Supply Recommendations.....	20
ΔR_{ON}	18	High-Current Drive and Precision Current-	
$R_{FLAT(ON)}$	18	Sense.....	20
I_S (Off).....	18	Digital Audio Channel to Ultra-Low THD.....	20
I_D (Off).....	18	Outline Dimensions.....	21
I_D (On) and I_S (On).....	18	Ordering Guide.....	21
V_{INL}	18	Evaluation Boards.....	21

REVISION HISTORY

1/2023—Revision 0: Initial Version

SPECIFICATIONS

OPERATING SUPPLY VOLTAGES

Table 1. Operating Supply Voltages

Supply Voltage	Min	Max	Unit
Dual Supply	±4.5	±16.5	V
Single Supply	+5	+16.5	V

±15 V DUAL SUPPLY

$V_{DD} = +15\text{ V} \pm 10\%$, $V_{SS} = -15\text{ V} \pm 10\%$, GND = 0 V, unless otherwise noted.

Table 2. ±15 V Dual-Supply Specifications

Parameter	+25°C	-40°C to +85°C	-40°C to +125°C	Unit	Test Conditions/Comments
ANALOG SWITCH					
Analog Signal Range			$V_{DD} - 2\text{ V to } V_{SS}$	V	$V_{DD} = +13.5\text{ V}$, $V_{SS} = -13.5\text{ V}$
On Resistance, R_{ON}	0.50			Ω typ	Source voltage (V_S) = -13.5 V to +10 V, source current (I_S) = -10 mA, see Figure 31
	0.65	0.8	0.95	Ω max	
	0.54			Ω typ	$V_S = -13.5\text{ V to } +11\text{ V}$, $I_S = -100\text{ mA}$
	0.7	0.85	1.0	Ω max	
On-Resistance Match Between Channels, ΔR_{ON}	0.003			Ω typ	$V_S = -13.5\text{ V to } +11\text{ V}$, $I_S = -100\text{ mA}$
	0.085	0.1	0.1	Ω max	
On-Resistance Flatness, $R_{FLAT(ON)}$	0.003			Ω typ	$V_S = -13.5\text{ V to } +10\text{ V}$, $I_S = -100\text{ mA}$
	0.035	0.035	0.035	Ω max	
	0.04			Ω typ	$V_S = -13.5\text{ V to } +11\text{ V}$, $I_S = -100\text{ mA}$
	0.08	0.1	0.1	Ω max	
LEAKAGE CURRENTS					
Source Off Leakage, I_S (Off)	±1.7			nA typ	$V_{DD} = +16.5\text{ V}$, $V_{SS} = -16.5\text{ V}$ $V_S = \pm 10\text{ V}$, drain voltage (V_D) = $\mp 10\text{ V}$, see Figure 34
	±4.0	+40/-5.5	+120/-5.5	nA max	
Drain Off Leakage, I_D (Off)	±1.7			nA typ	$V_S = \pm 10\text{ V}$, $V_D = \mp 10\text{ V}$, see Figure 34
	±4.0	+40/-5.5	+120/-5.5	nA max	
Channel On Leakage, I_D (On), I_S (On)	±0.1			nA typ	$V_S = V_D = \pm 10\text{ V}$, see Figure 30
	±1.3	±3	+12.5/-3	nA max	
DIGITAL INPUTS					
Input High Voltage, V_{INH}			1.3	V min	
Input Low Voltage, V_{INL}			0.8	V max	
Input Current, I_{INL} , or I_{INH}	0.01			μA typ	Input voltage (V_{IN}) = GND voltage (V_{GND}) or V_{DD}
			±0.15	μA max	
Digital Input Capacitance, C_{IN}	4.6			pF typ	
DYNAMIC CHARACTERISTICS					
On Time, t_{ON}	336			ns typ	Load resistance (R_L) = 300 Ω , load capacitance (C_L) = 35 pF
	403	434	478	ns max	$V_S = 10\text{ V}$, see Figure 37
Off Time, t_{OFF}	188			ns typ	$R_L = 300\text{ }\Omega$, $C_L = 35\text{ pF}$
	221	223	223	ns max	$V_S = 10\text{ V}$, see Figure 37
Charge Injection, Q_{INJ}	-1.8			nC typ	$V_S = 0\text{ V}$, $R_S = 0\text{ }\Omega$, $C_L = 1\text{ nF}$, see Figure 38
Off Isolation	-76			dB typ	$R_L = 50\text{ }\Omega$, $C_L = 5\text{ pF}$, frequency = 100 kHz, see Figure 33

SPECIFICATIONS

Table 2. ± 15 V Dual-Supply Specifications (Continued)

Parameter	+25°C	-40°C to +85°C	-40°C to +125°C	Unit	Test Conditions/Comments
Channel-to-Channel Crosstalk	-105			dB typ	$R_L = 50 \Omega$, $C_L = 5$ pF, frequency = 100 kHz, see Figure 32
Total Harmonic Distortion + Noise, THD + N	0.002			% typ	$R_L = 1$ k Ω , 20 V p-p, frequency = 20 Hz to 20 kHz, see Figure 35
Total Harmonic Distortion, THD	-122			dB typ	$R_L = 1$ k Ω , 20 V p-p, frequency = 1 kHz
	-96			dB typ	$R_L = 1$ k Ω , 20 V p-p, frequency = 20 kHz
	-80			dB typ	$R_L = 1$ k Ω , 20 V p-p, frequency = 100 kHz
-3 dB Bandwidth	171			MHz typ	$R_L = 50 \Omega$, $C_L = 5$ pF, signal = 0 dBm, see Figure 36
Insertion Loss	-0.04			dB typ	$R_L = 50 \Omega$, $C_L = 5$ pF, frequency = 1 MHz, see Figure 36
Source Off Capacitance, C_S (Off)	76			pF typ	$V_S = 0$ V, frequency = 1 MHz
Drain Off Capacitance, C_D (Off)	76			pF typ	$V_S = 0$ V, frequency = 1 MHz
Drain On Capacitance, C_D (On), Source On Capacitance C_S (On)	28			pF typ	$V_S = 0$ V, frequency = 1 MHz
Match On Capacitance, C_{MATCH} (On)	0.84			pF typ	$V_S = 0$ V, frequency = 1 MHz
POWER REQUIREMENTS					
Power Supply Current, I_{DD}	170			μ A typ	$V_{DD} = +16.5$ V, $V_{SS} = -16.5$ V Digital inputs = 0 V or 5 V
	260		260	μ A max	
	225			μ A typ	Digital inputs = 1.3 V
	330		330	μ A max	
Negative Supply Current, I_{SS}	85			μ A typ	Digital inputs = 0 V or 5 V
	140		140	μ A max	

12 V SINGLE SUPPLY

$V_{DD} = 12$ V \pm 10%, $V_{SS} = 0$ V, GND = 0 V, unless otherwise noted.

Table 3. 12 V Single-Supply Specifications

Parameter	+25°C	-40°C to +85°C	-40°C to +125°C	Unit	Test Conditions/Comments
ANALOG SWITCH					
ANALOG SWITCH					$V_{DD} = 10.8$ V, $V_{SS} = 0$ V
Analogue Signal Range			0 V to $V_{DD} - 2$ V	V	
On Resistance, R_{ON}	0.50			Ω typ	Source voltage (V_S) = 0 V to 7.3 V, source current (I_S) = -100 mA, see Figure 31
	0.65	0.8	0.95	Ω max	
	0.54			Ω typ	$V_S = 0$ V to 8.3 V, $I_S = -100$ mA
	0.7	0.85	1.0	Ω max	
On-Resistance Match Between Channels, ΔR_{ON}	0.003			Ω typ	$V_S = 0$ V to 8.3 V, $I_S = -100$ mA
	0.085	0.1	0.1	Ω max	
On-Resistance Flatness, $R_{FLAT(ON)}$	0.003			Ω typ	$V_S = 0$ V to 7.3 V, $I_S = -100$ mA
	0.035	0.035	0.035	Ω max	
	0.04			Ω typ	$V_S = 0$ V to 8.3 V, $I_S = -100$ mA
	0.08	0.1	0.1	Ω max	
LEAKAGE CURRENTS					
Source Off Leakage, I_S (Off)	± 1.7			nA typ	$V_{DD} = 13.2$ V, $V_{SS} = 0$ V $V_S = 1$ V/10 V, drain voltage (V_D) = 10 V/1 V, see Figure 34
Drain Off Leakage, I_D (Off)	± 4.0	+40/-5.5	+120/-5.5	nA max	
	± 1.7			nA typ	$V_S = 1$ V/10 V, $V_D = 10$ V/1 V, see Figure 34

SPECIFICATIONS

Table 3. 12 V Single-Supply Specifications (Continued)

Parameter	+25°C	-40°C to +85°C	-40°C to +125°C	Unit	Test Conditions/Comments
Channel On Leakage, I_D (On), I_S (On)	±4.0 ±0.1 ±1.3	+40/-5.5 ±3	+120/-5.5 +12.5/-3	nA max nA typ nA max	$V_S = V_D = 1\text{ V}/10\text{ V}$, see Figure 30
DIGITAL INPUTS					
Input High Voltage, V_{INH}			1.3	V min	Input voltage (V_{IN}) = GND voltage (V_{GND}) or V_{DD}
Input Low Voltage, V_{INL}			0.8	V max	
Input Current, I_{INL} , or I_{INH}	0.01			μA typ	
Digital Input Capacitance, C_{IN}	4.6		±0.15	μA max pF typ	
DYNAMIC CHARACTERISTICS					
On Time, t_{ON}	207			ns typ	Load resistance (R_L) = 300 Ω, load capacitance (C_L) = 35 pF
Off Time, t_{OFF}	247	259	275	ns max	$V_S = 8\text{ V}$, see Figure 37
	301			ns typ	$R_L = 300\text{ Ω}$, $C_L = 35\text{ pF}$
	352	365	376	ns max	$V_S = 8\text{ V}$, see Figure 37
Charge Injection, Q_{INJ}	-1.1			nC typ	$V_S = 6\text{ V}$, $R_S = 0\text{ Ω}$, $C_L = 1\text{ nF}$, see Figure 38
Off Isolation	-61			dB typ	$R_L = 50\text{ Ω}$, $C_L = 5\text{ pF}$, frequency = 100 kHz, see Figure 33
Channel-to-Channel Crosstalk	-105			dB typ	$R_L = 50\text{ Ω}$, $C_L = 5\text{ pF}$, frequency = 100 kHz, see Figure 32
Total Harmonic Distortion + Noise, THD + N	0.005			% typ	$R_L = 1\text{ kΩ}$, 6 V p-p, frequency = 20 Hz to 20 kHz, see Figure 35
Total Harmonic Distortion, THD	-111			dB typ	$R_L = 1\text{ kΩ}$, 6 V p-p, frequency = 1 kHz
	-85			dB typ	$R_L = 1\text{ kΩ}$, 6 V p-p, frequency = 20 kHz
	-71			dB typ	$R_L = 1\text{ kΩ}$, 6 V p-p, frequency = 100 kHz
-3 dB Bandwidth	114			MHz typ	$R_L = 50\text{ Ω}$, $C_L = 5\text{ pF}$, signal = 0 dBm, see Figure 36
Insertion Loss	-0.05			dB typ	$R_L = 50\text{ Ω}$, $C_L = 5\text{ pF}$, frequency = 1 MHz, see Figure 36
Source Off Capacitance, C_S (Off)	100			pF typ	$V_S = 6\text{ V}$, frequency = 1 MHz
Drain Off Capacitance, C_D (Off)	100			pF typ	$V_S = 6\text{ V}$, frequency = 1 MHz
Drain On Capacitance, C_D (On), Source On Capacitance, C_S (On)	37			pF typ	$V_S = 6\text{ V}$, frequency = 1 MHz
Match On Capacitance, C_{MATCH} (On)	0.69			pF typ	$V_S = 6\text{ V}$, frequency = 1 MHz
POWER REQUIREMENTS					
Power Supply Current, I_{DD}	170			μA typ	$V_{DD} = 13.2\text{ V}$
	260		260	μA max	Digital inputs = 0 V or 5 V
	225			μA typ	Digital inputs = 1.3 V
	330		330	μA max	
Negative Supply Current, I_{SS}	85			μA typ	Digital inputs = 0 V or 5 V
	140		140	μA max	

SPECIFICATIONS

DUAL AND ASYMMETRIC SUPPLY

$V_{DD} = +5\text{ V} \pm 10\%$, $V_{SS} = -5\text{ V to } -12\text{ V} \pm 10\%$, $GND = 0\text{ V}$, unless otherwise noted.

Table 4. Dual and Asymmetric Supply Specifications

Parameter	+25°C	-40°C to +85°C	-40°C to +125°C	Unit	Test Conditions/Comments
ANALOG SWITCH					
Analog Signal Range			$V_{DD} - 2\text{ V to } V_{SS}$	V	$V_{DD} = +4.5\text{ V}$, $V_{SS} = -13.2\text{ V}$
On Resistance, R_{ON}	0.50			Ω typ	Source voltage (V_S) = V_{SS} to +1 V, source current (I_S) = -100 mA, see Figure 31
	0.65	0.8	0.95	Ω max	
	0.54			Ω typ	$V_S = V_{SS}$ to +2 V, $I_S = -100\text{ mA}$
	0.70	0.85	1.0	Ω max	
On-Resistance Match Between Channels, ΔR_{ON}	0.003			Ω typ	$V_S = V_{SS}$ to +2 V, $I_S = -100\text{ mA}$
	0.085	0.1	0.1	Ω max	
On-Resistance Flatness, $R_{FLAT(ON)}$	0.003			Ω typ	$V_S = V_{SS}$ to +1 V, $I_S = -100\text{ mA}$
	0.035	0.035	0.035	Ω max	
	0.04			Ω typ	$V_S = V_{SS}$ to +2 V, $I_S = -100\text{ mA}$
	0.08	0.1	0.1	Ω max	
LEAKAGE CURRENTS					
Source Off Leakage, I_S (Off)	± 1.7			nA typ	$V_{DD} = +5.5\text{ V}$, $V_{SS} = -13.2\text{ V}$ $V_S = +1\text{ V or } -10\text{ V}$, $V_D = -10\text{ V or } +1\text{ V}$, see Figure 34
	± 4.0	+40/-5.5	+120/-5.5	nA max	
Drain Off Leakage, I_D (Off)	± 1.7			nA typ	$V_S = +1\text{ V or } -10\text{ V}$, $V_D = -10\text{ V or } +1\text{ V}$, see Figure 34
	± 4.0	+40/-5.5	+120/-5.5	nA max	
Channel On Leakage, I_D (On), I_S (On)	± 0.1			nA typ	$V_S = V_D = +3\text{ V or } -10\text{ V}$, see Figure 30
	± 1.3	± 3	+12.5/-3	nA max	
DIGITAL INPUTS					
Input High Voltage, V_{INH}			1.3	V min	
Input Low Voltage, V_{INL}			0.8	V max	
Input Current, I_{INL} or I_{INH}	0.01			μA typ	Input voltage (V_{IN}) = GND voltage (V_{GND}) or V_{DD}
			± 0.15	μA max	
Digital Input Capacitance, C_{IN}	4.6			pF typ	
DYNAMIC CHARACTERISTICS					
On Time, t_{ON}	333			ns typ	$V_{DD} = +5\text{ V}$, $V_{SS} = -12\text{ V}$ Load resistance (R_L) = 300 Ω , load capacitance (C_L) = 35 pF
	398	442	483	ns max	$V_S = 1.5\text{ V}$, see Figure 37
Off Time, t_{OFF}	250			ns typ	$R_L = 300\text{ }\Omega$, $C_L = 35\text{ pF}$
	292	297	301	ns max	$V_S = 1.5\text{ V}$, see Figure 37
Charge Injection, Q_{INJ}	-1.94			nC typ	$V_S = -3\text{ V}$, $R_S = 0\text{ }\Omega$, $C_L = 1\text{ nF}$, see Figure 38
Off Isolation	-70			dB typ	$R_L = 50\text{ }\Omega$, $C_L = 5\text{ pF}$, frequency = 100 kHz, see Figure 33
Channel-to-Channel Crosstalk	-105			dB typ	$R_L = 50\text{ }\Omega$, $C_L = 5\text{ pF}$, frequency = 100 kHz, see Figure 32
Total Harmonic Distortion + Noise, THD + N	0.002			% typ	$R_L = 1\text{ k}\Omega$, 3 V p-p, frequency = 20 Hz to 20 kHz, see Figure 35
Total Harmonic Distortion, THD	-126			dB typ	$R_L = 1\text{ k}\Omega$, 3 V p-p, frequency = 1 kHz
	-103			dB typ	$R_L = 1\text{ k}\Omega$, 3 V p-p, frequency = 20 kHz

SPECIFICATIONS

Table 4. Dual and Asymmetric Supply Specifications (Continued)

Parameter	+25°C	-40°C to +85°C	-40°C to +125°C	Unit	Test Conditions/Comments
-3 dB Bandwidth	-89			dB typ	$R_L = 1\text{ k}\Omega$, 3 V p-p, frequency = 100 kHz $R_L = 50\ \Omega$, $C_L = 5\text{ pF}$, signal = 0 dBm, see Figure 36
	124			MHz typ	
Insertion Loss	-0.05			dB typ	$R_L = 50\ \Omega$, $C_L = 5\text{ pF}$, frequency = 1 MHz see Figure 36
Source Off Capacitance, C_S (Off)	105			pF typ	$V_S = 0\text{ V}$, frequency = 1 MHz
Drain Off Capacitance, C_D (Off)	105			pF typ	$V_S = 0\text{ V}$, frequency = 1 MHz
Drain On Capacitance, C_D (On), Source On Capacitance, C_S (On)	39			pF typ	$V_S = 0\text{ V}$, frequency = 1 MHz
Match On Capacitance, C_{MATCH} (On)	0.94			pF typ	$V_S = 0\text{ V}$, frequency = 1 MHz
POWER REQUIREMENTS					
Power Supply Current, I_{DD}	170			μA typ	$V_{DD} = +5.5\text{ V}$, $V_{SS} = -13.2\text{ V}$ Digital inputs = 0 V or 5 V
	260		260	μA max	
	225			μA typ	Digital inputs = 1.3 V
	330		330	μA max	
Negative Supply Current, I_{SS}	85			μA typ	Digital inputs = 0 V or 5 V
	140		140	μA max	

CONTINUOUS CURRENT PER CHANNEL, Sx OR Dx

Table 5. One Channel On, Per Channel Specifications

Parameter	25°C	85°C	125°C	Unit	Test Conditions/Comments
CONTINUOUS CURRENT, Sx OR Dx					
$V_{DD} = +15\text{ V}$, $V_{SS} = -15\text{ V}$ LFCSP ($\theta_{JA} = 44^\circ\text{C/W}$)	847	325	123	mA maximum	$V_S = V_{SS}$ to $V_{DD} - 3.5\text{ V}$
$V_{DD} = 12\text{ V}$, $V_{SS} = 0\text{ V}$ LFCSP ($\theta_{JA} = 44^\circ\text{C/W}$)	847	325	123	mA maximum	$V_S = V_{SS}$ to $V_{DD} - 3.5\text{ V}$
$V_{DD} = +5\text{ V}$, $V_{SS} = -5\text{ V}$ LFCSP ($\theta_{JA} = 44^\circ\text{C/W}$)	847	325	123	mA maximum	$V_S = V_{SS}$ to $V_{DD} - 3.5\text{ V}$
$V_{DD} = +5\text{ V}$, $V_{SS} = -12\text{ V}$ LFCSP ($\theta_{JA} = 44^\circ\text{C/W}$)	847	325	123	mA maximum	$V_S = V_{SS}$ to $V_{DD} - 3.5\text{ V}$

Table 6. Two Channels On, Per Channel Specifications

Parameter	25°C	85°C	125°C	Unit	Test Conditions/Comments
CONTINUOUS CURRENT, Sx OR Dx					
$V_{DD} = +15\text{ V}$, $V_{SS} = -15\text{ V}$ LFCSP ($\theta_{JA} = 44^\circ\text{C/W}$)	646	289	120	mA maximum	$V_S = V_{SS}$ to $V_{DD} - 3.5\text{ V}$
$V_{DD} = 12\text{ V}$, $V_{SS} = 0\text{ V}$ LFCSP ($\theta_{JA} = 44^\circ\text{C/W}$)	646	289	120	mA maximum	$V_S = V_{SS}$ to $V_{DD} - 3.5\text{ V}$
$V_{DD} = +5\text{ V}$, $V_{SS} = -5\text{ V}$ LFCSP ($\theta_{JA} = 44^\circ\text{C/W}$)	646	289	120	mA maximum	$V_S = V_{SS}$ to $V_{DD} - 3.5\text{ V}$
$V_{DD} = +5\text{ V}$, $V_{SS} = -12\text{ V}$ LFCSP ($\theta_{JA} = 44^\circ\text{C/W}$)	646	289	120	mA maximum	$V_S = V_{SS}$ to $V_{DD} - 3.5\text{ V}$

Table 7. Three Channels On, Per Channel Specifications

Parameter	25°C	85°C	125°C	Unit	Test Conditions/Comments
CONTINUOUS CURRENT, Sx OR Dx					
$V_{DD} = +15\text{ V}$, $V_{SS} = -15\text{ V}$ LFCSP ($\theta_{JA} = 44^\circ\text{C/W}$)	548	265	117	mA maximum	$V_S = V_{SS}$ to $V_{DD} - 3.5\text{ V}$

SPECIFICATIONS

Table 7. Three Channels On, Per Channel Specifications (Continued)

Parameter	25°C	85°C	125°C	Unit	Test Conditions/Comments
$V_{DD} = 12\text{ V}, V_{SS} = 0\text{ V}$ LFCSP ($\theta_{JA} = 44^\circ\text{C/W}$)	548	265	117	mA maximum	$V_S = V_{SS} \text{ to } V_{DD} - 3.5\text{ V}$
$V_{DD} = +5\text{ V}, V_{SS} = -5\text{ V}$ LFCSP ($\theta_{JA} = 44^\circ\text{C/W}$)	548	265	117	mA maximum	$V_S = V_{SS} \text{ to } V_{DD} - 3.5\text{ V}$
$V_{DD} = +5\text{ V}, V_{SS} = -12\text{ V}$ LFCSP ($\theta_{JA} = 44^\circ\text{C/W}$)	548	265	117	mA maximum	$V_S = V_{SS} \text{ to } V_{DD} - 3.5\text{ V}$

Table 8. Four Channels On, Per Channel Specifications

Parameter	25°C	85°C	125°C	Unit	Test Conditions/Comments
CONTINUOUS CURRENT, Sx OR Dx $V_{DD} = +15\text{ V}, V_{SS} = -15\text{ V}$ LFCSP ($\theta_{JA} = 44^\circ\text{C/W}$)	488	248	115	mA maximum	$V_S = V_{SS} \text{ to } V_{DD} - 3.5\text{ V}$
$V_{DD} = 12\text{ V}, V_{SS} = 0\text{ V}$ LFCSP ($\theta_{JA} = 44^\circ\text{C/W}$)	488	248	115	mA maximum	$V_S = V_{SS} \text{ to } V_{DD} - 3.5\text{ V}$
$V_{DD} = +5\text{ V}, V_{SS} = -5\text{ V}$ LFCSP ($\theta_{JA} = 44^\circ\text{C/W}$)	488	248	115	mA maximum	$V_S = V_{SS} \text{ to } V_{DD} - 3.5\text{ V}$
$V_{DD} = +5\text{ V}, V_{SS} = -12\text{ V}$ LFCSP ($\theta_{JA} = 44^\circ\text{C/W}$)	488	248	115	mA maximum	$V_S = V_{SS} \text{ to } V_{DD} - 3.5\text{ V}$

ABSOLUTE MAXIMUM RATINGS

$T_A = 25^\circ\text{C}$, unless otherwise noted.

Table 9. Absolute Maximum Ratings

Parameter	Rating
V_{DD} to V_{SS}	35 V
V_{DD} to GND	-0.3 V to +25 V
V_{SS} to GND	+0.3 V to -25 V
Analog Inputs ¹	$V_{SS} - 0.3\text{ V}$ to $V_{DD} + 0.3\text{ V}$ or 30 mA, whichever occurs first
Digital Inputs ¹	GND - 0.3 V to +6 V or 30 mA, whichever occurs first
Peak Current, Sx or Dx Pins ²	2.6 A (pulsed at 1 ms, 10% duty cycle maximum)
Continuous Current, Sx or Dx ²	Data ³ + 15%
Temperature	
Operating Range	-40°C to +125°C
Storage Range	-65°C to +150°C
Junction	150°C
Reflow Soldering Peak, Pb-Free	As per JEDEC J-STD-020

¹ Overvoltages at the INx, Sx, and Dx pins are clamped by internal diodes. Limit current to the maximum ratings given.

² Sx refers to the S1 to S4 pins, and Dx refers to the D1 to D4 pins.

³ See Table 5 to Table 8.

Stresses at or above those listed under Absolute Maximum Ratings may cause permanent damage to the product. This is a stress rating only; functional operation of the product at these or any other conditions above those indicated in the operational section of this specification is not implied. Operation beyond the maximum operating conditions for extended periods may affect product reliability.

Only one absolute maximum rating can be applied at any one time.

THERMAL RESISTANCE

Thermal performance is directly linked to printed circuit board (PCB) design and operating environment. Careful attention to PCB thermal design is required.

θ_{JA} is the natural convection junction-to-ambient thermal resistance measured in a one cubic foot sealed enclosure, and θ_{JCB} is the junction to the bottom of the case value.

Table 10. Thermal Resistance

Package Type	θ_{JA}	θ_{JCB}	Unit
CP-16-17 ¹	44	17.4	°C/W

¹ Thermal impedance simulated values are based on JEDEC 2S2P thermal test board without thermal vias. See JEDEC JESD-51.

ELECTROSTATIC DISCHARGE (ESD) RATINGS

The following ESD information is provided for handling of ESD-sensitive devices in an ESD protected area only.

Human body model (HBM) per ANSI/ESDA/JEDEC JS-001.

Field induced charged-device model (FICDM) per ANSI/ESDA/JEDEC JS-002.

ESD Ratings for the ADG2412

Table 11. ADG2412, 16-Lead LFCSP

ESD Model	Withstand Threshold (V)	Class
HBM	±2000	2
FICDM	±1250	C3

ESD CAUTION



ESD (electrostatic discharge) sensitive device. Charged devices and circuit boards can discharge without detection. Although this product features patented or proprietary protection circuitry, damage may occur on devices subjected to high energy ESD. Therefore, proper ESD precautions should be taken to avoid performance degradation or loss of functionality.

PIN CONFIGURATION AND FUNCTION DESCRIPTIONS

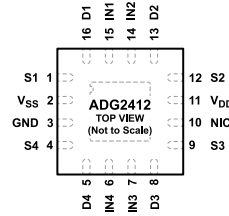

NOTES
 1. NIC = NOT INTERNALLY CONNECTED.
 2. THE EXPOSED PAD IS CONNECTED INTERNALLY. FOR INCREASED RELIABILITY OF THE SOLDER JOINTS AND MAXIMUM THERMAL CAPABILITY, IT IS RECOMMENDED THAT THE PAD BE SOLDERED TO THE SUBSTRATE, V_{SS}.

Figure 2. Pin Configuration

Table 12. Pin Function Descriptions

Pin Number	Mnemonic	Description
1	S1	Source Terminal 1. This pin can be an input or output.
2	V _{SS}	Most Negative Power-Supply Potential. Decouple the V _{SS} pin using a 0.1 μF capacitor to GND.
3	GND	Ground (0 V) Reference.
4	S4	Source Terminal 4. This pin can be an input or output.
5	D4	Drain Terminal 4. This pin can be an input or output.
6	IN4	Logic Control Input 4.
7	IN3	Logic Control Input 3.
8	D3	Drain Terminal 3. This pin can be an input or output.
9	S3	Source Terminal 3. This pin can be an input or output.
10	NIC	Not Internally Connected.
11	V _{DD}	Most Positive Power-Supply Potential. Decouple the V _{DD} pin using a 0.1 μF capacitor to GND.
12	S2	Source Terminal 2. This pin can be an input or output.
13	D2	Drain Terminal 2. This pin can be an input or output.
14	IN2	Logic Control Input 2.
15	IN1	Logic Control Input 1.
16	D1	Drain Terminal 1. This pin can be an input or output.
EP	Exposed Pad	The exposed pad is connected internally. For increased reliability of the solder joints and maximum thermal capability, it is recommended that the pad be soldered to the substrate, V _{SS} .

Table 13. ADG2412 Truth Table

INx	Switch Condition
1	On
0	Off

TYPICAL PERFORMANCE CHARACTERISTICS

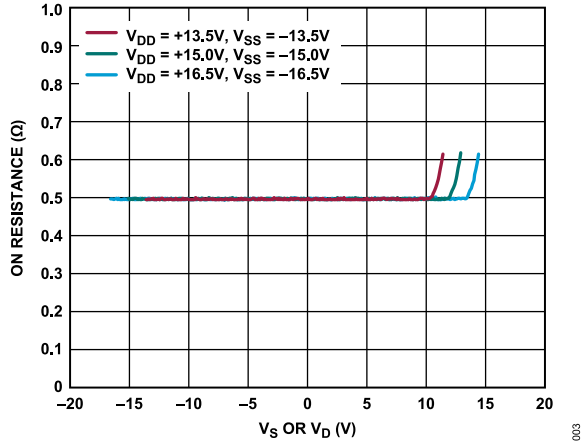

Figure 3. R_{ON} as a Function of V_S , V_D (Dual Supply)

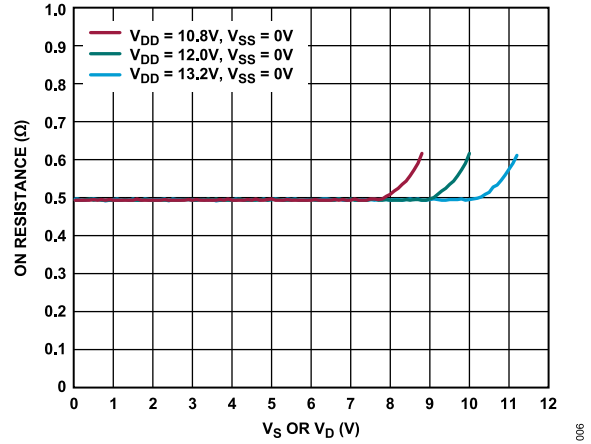

Figure 6. R_{ON} as a Function of V_S , V_D (Single Supply)

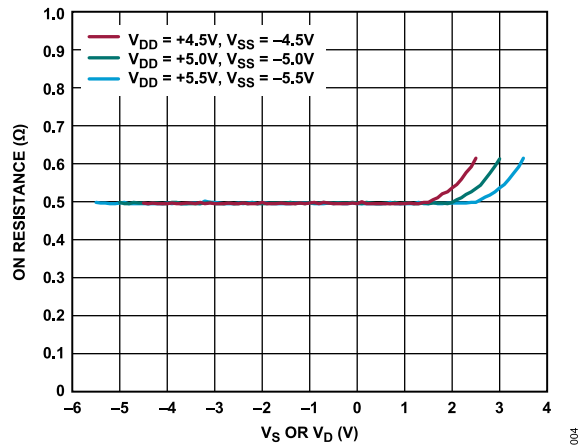

Figure 4. R_{ON} as a Function of V_S , V_D (Dual Supply)

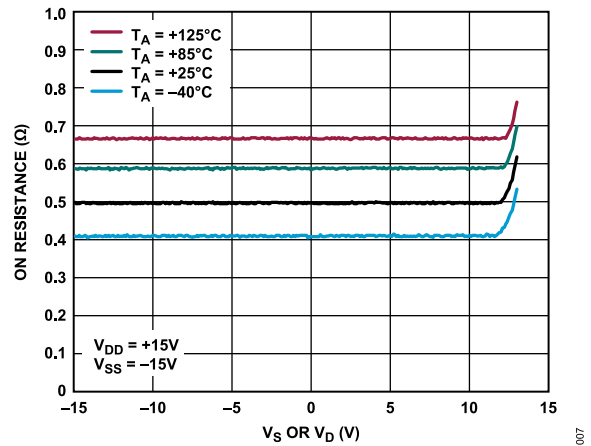

Figure 7. R_{ON} as a Function of V_S (V_D) for Different Temperatures, ± 15 V Dual Supply

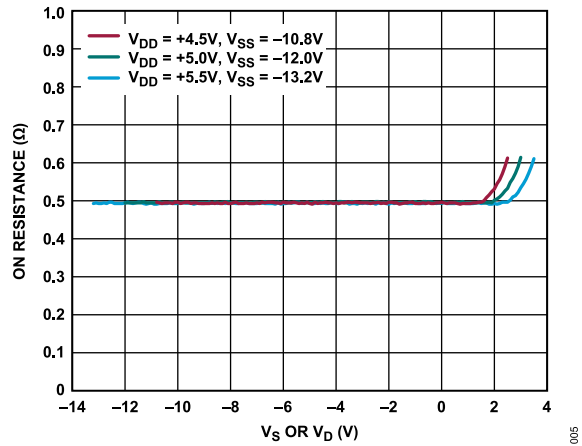

Figure 5. R_{ON} as a Function of V_S , V_D (Dual Supply)

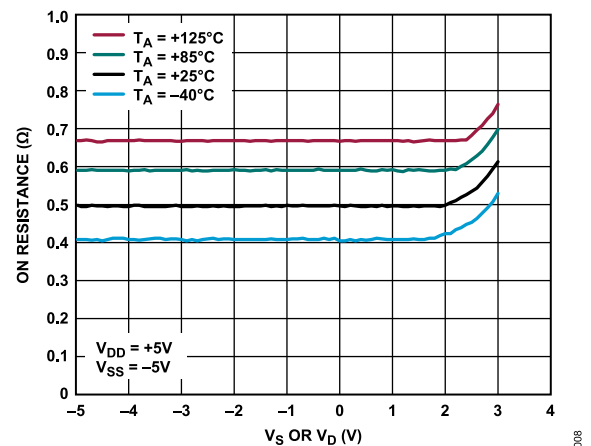

Figure 8. R_{ON} as a Function of V_S (V_D) for Different Temperatures, ± 5 V Dual Supply

TYPICAL PERFORMANCE CHARACTERISTICS

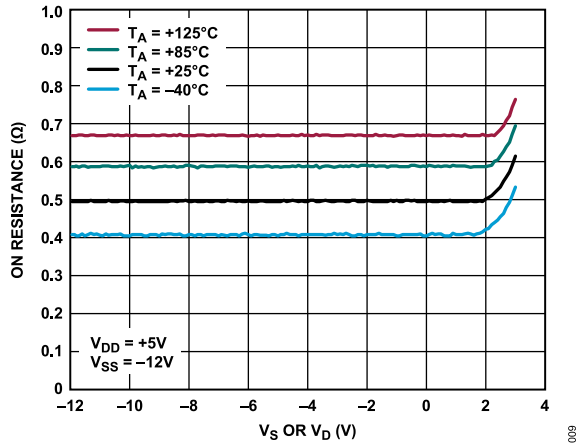

Figure 9. R_{ON} as a Function of V_S (V_D) for Different Temperatures, +5 V, -12 V Dual Supply

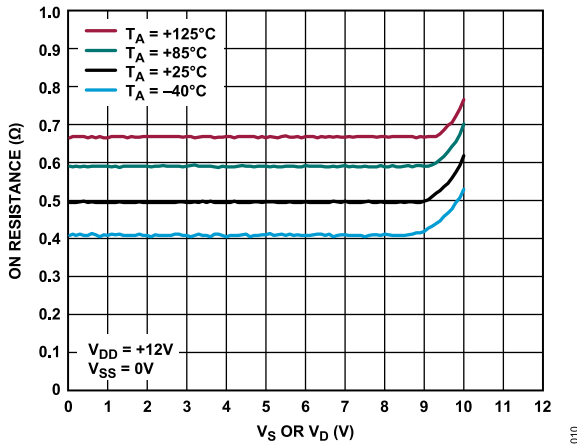

Figure 10. R_{ON} as a Function of V_S (V_D) for Different Temperatures, +12 V Single Supply

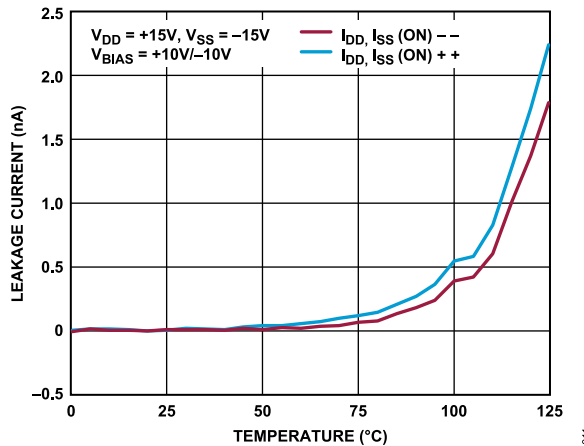

Figure 11. On Leakage Currents vs. Temperature, ±15 V Dual Supply

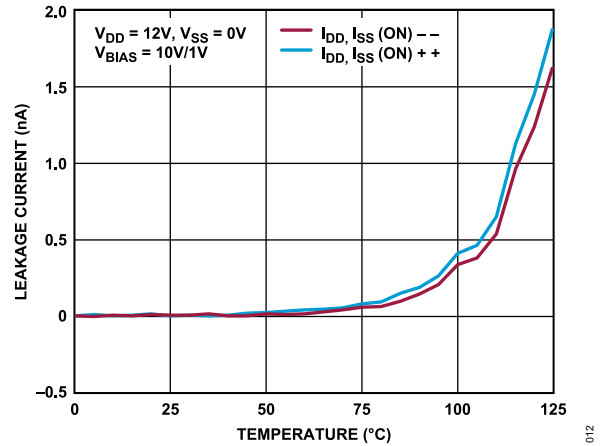

Figure 12. On Leakage Currents vs. Temperature, +12 V Single Supply

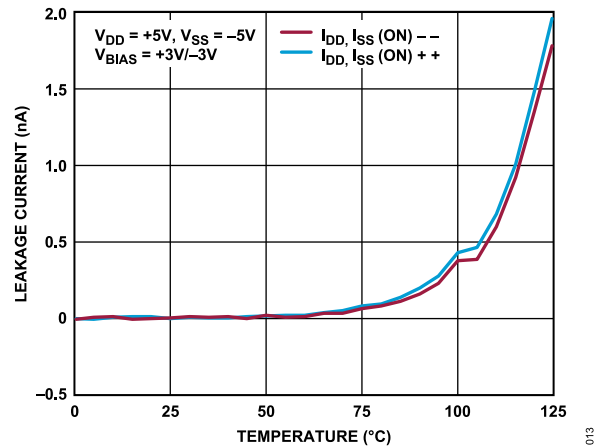

Figure 13. On Leakage Currents vs. Temperature, ±5 V Dual Supply

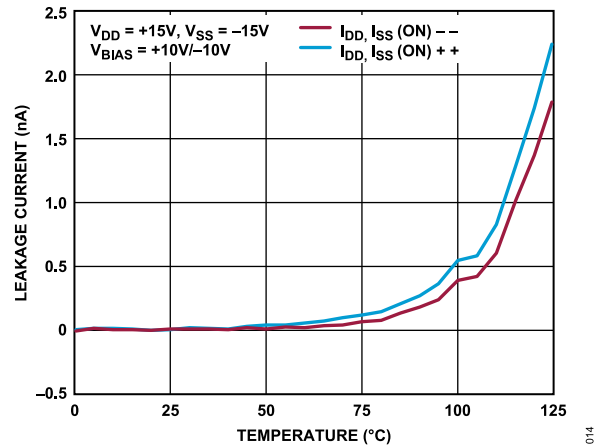

Figure 14. On Leakage Currents vs. Temperature, +5 V, -12 V Dual Supply

TYPICAL PERFORMANCE CHARACTERISTICS

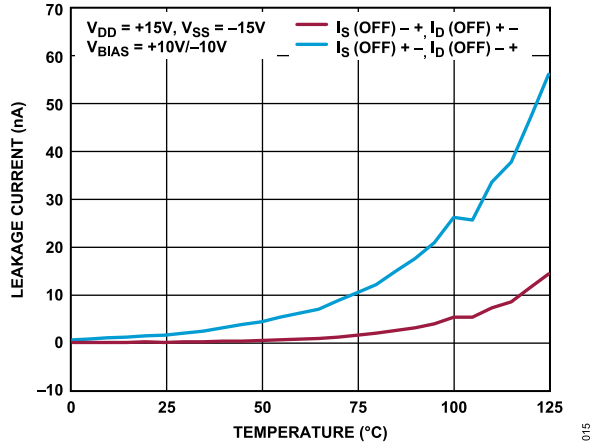

Figure 15. Off Leakage Currents vs. Temperature, ±15 V Dual Supply

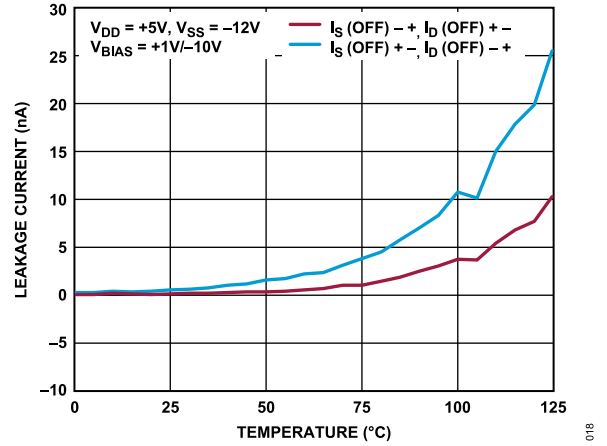

Figure 18. Off Leakage Currents vs. Temperature, +5 V, -12 V Dual Supply

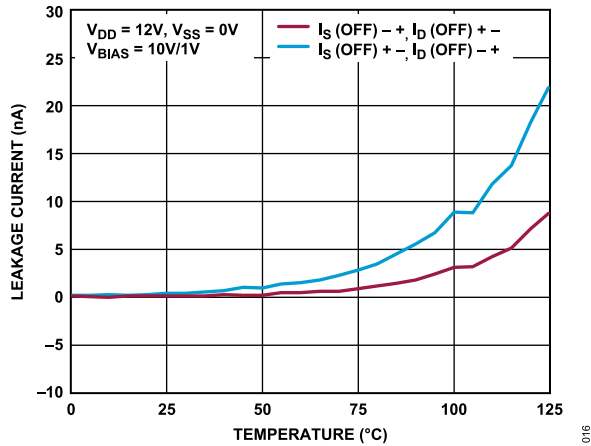

Figure 16. Off Leakage Currents vs. Temperature, +12 V Single Supply

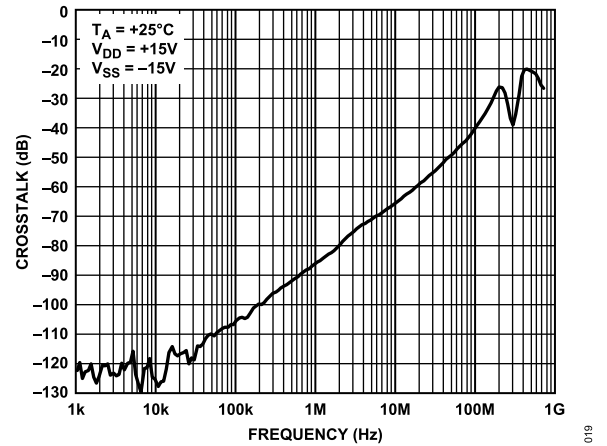

Figure 19. Crosstalk vs. Frequency, ±15 V Dual Supply

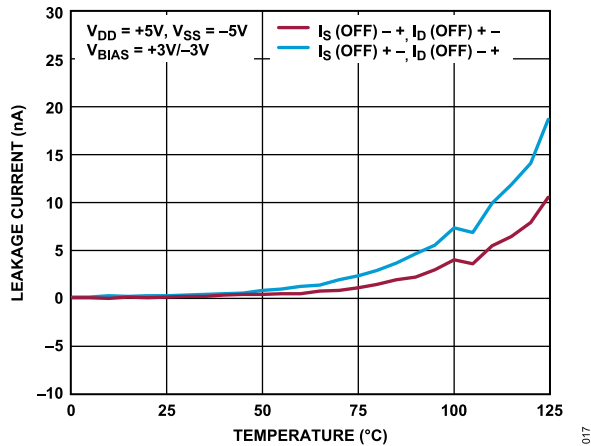

Figure 17. Off Leakage Currents vs. Temperature, ±5 V Dual Supply

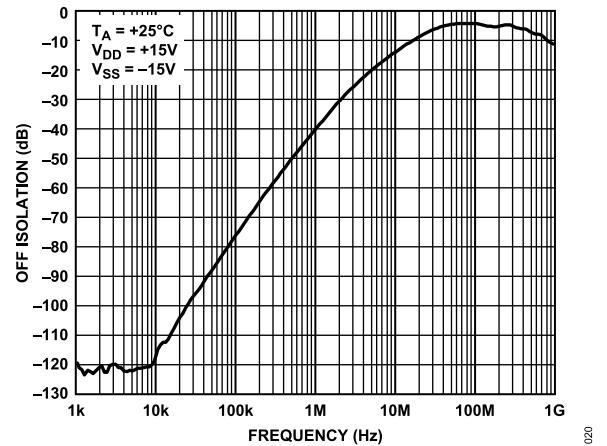

Figure 20. Off Isolation vs. Frequency, ±15 V Dual Supply

TYPICAL PERFORMANCE CHARACTERISTICS

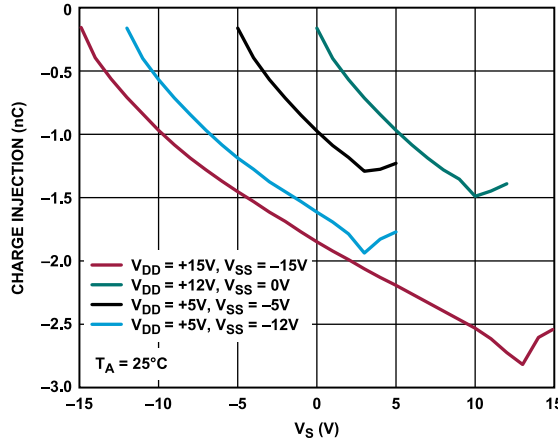

Figure 21. Charge Injection vs. V_S

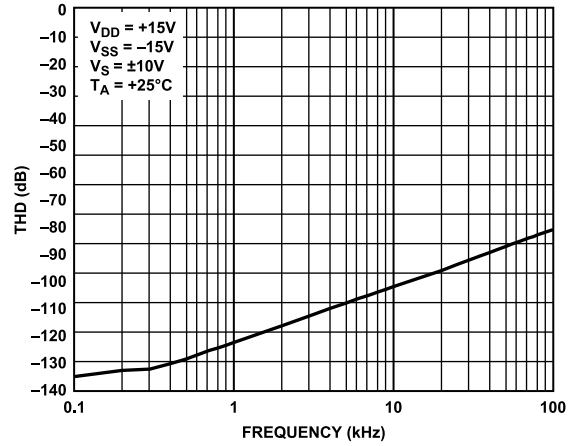

Figure 24. THD vs. Frequency, ± 15 V Dual Supply

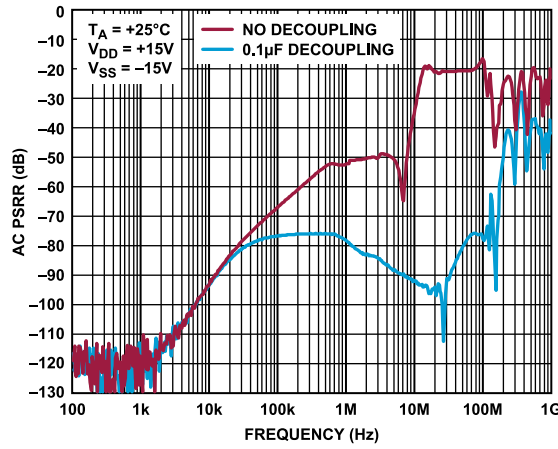

Figure 22. AC PSRR vs. Frequency, ± 15 V Dual Supply

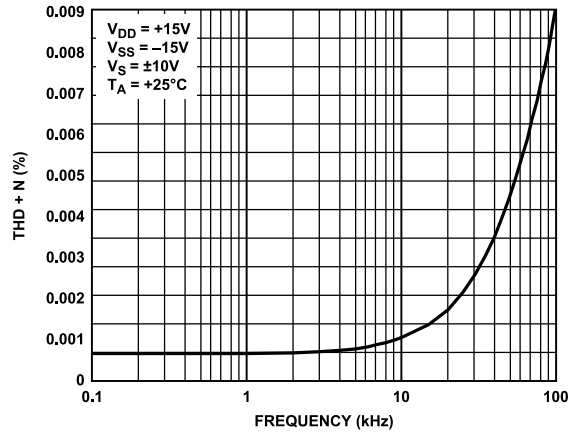

Figure 25. THD + N vs. Frequency, ± 15 V Dual Supply

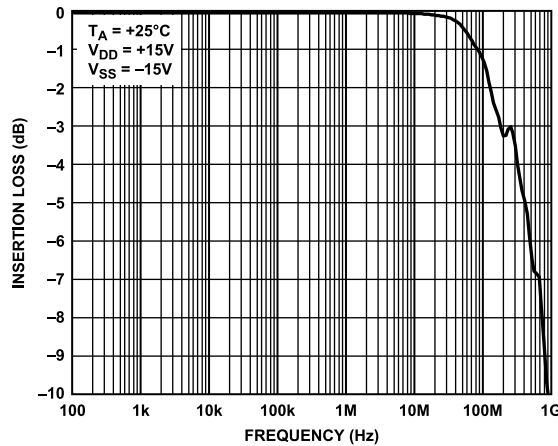

Figure 23. Insertion Loss vs. Frequency

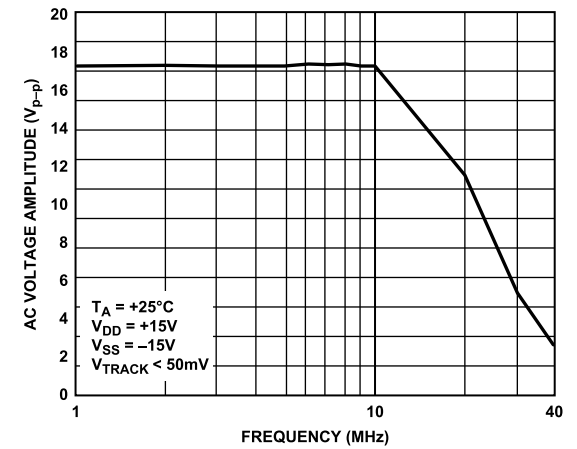

Figure 26. Large AC Signal Voltage vs. Frequency

TYPICAL PERFORMANCE CHARACTERISTICS

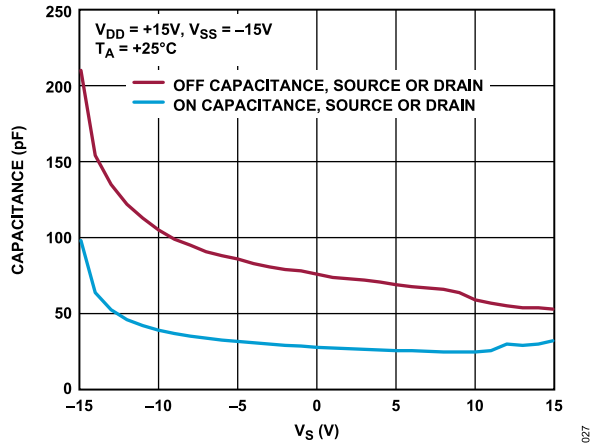

Figure 27. Capacitance vs. V_S , ± 15 V Dual Supply

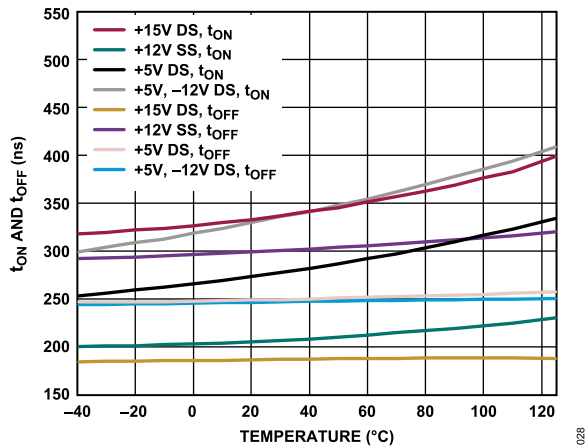

Figure 28. t_{ON} , t_{OFF} Times vs. Temperature

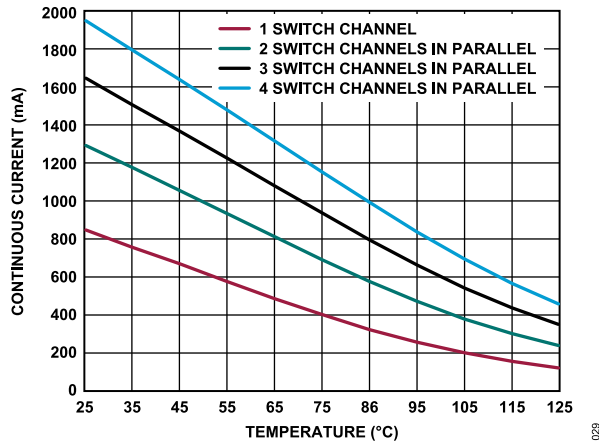

Figure 29. Continuous Current vs. Temperature, Various Number of Switch Channels in Parallel

TEST CIRCUITS

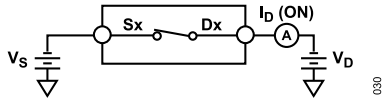

Figure 30. On Leakage

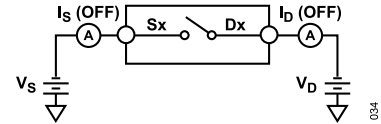

Figure 34. Off Leakage

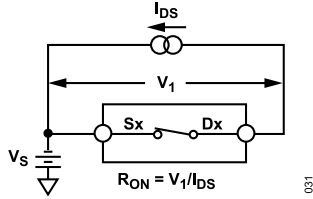
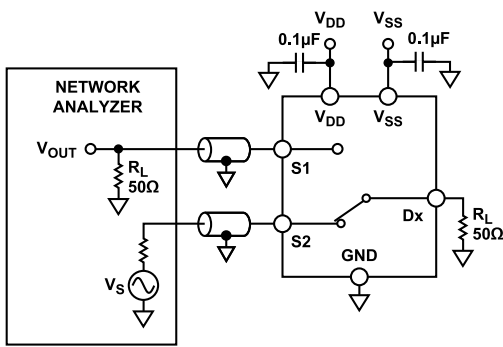

Figure 31. On Resistance

$$R_{ON} = V_1 / I_{DS}$$



$$\text{CHANNEL-TO-CHANNEL CROSSTALK} = 20 \log \frac{V_{OUT}}{V_S}$$

Figure 32. Channel-to-Channel Crosstalk

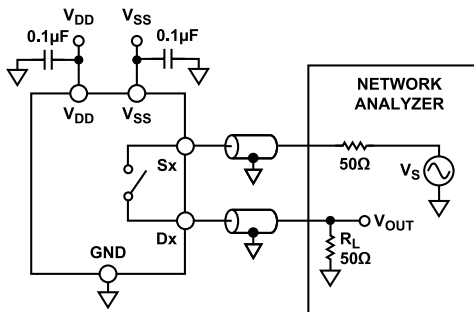

$$\text{OFF ISOLATION} = 20 \log \frac{V_{OUT}}{V_S}$$

Figure 33. Off Isolation

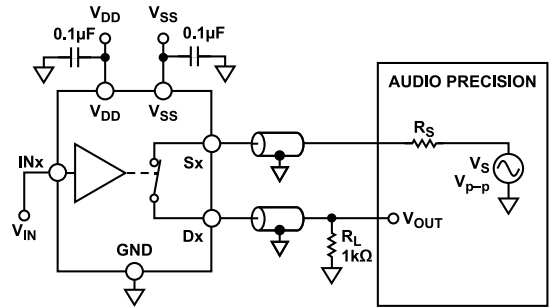
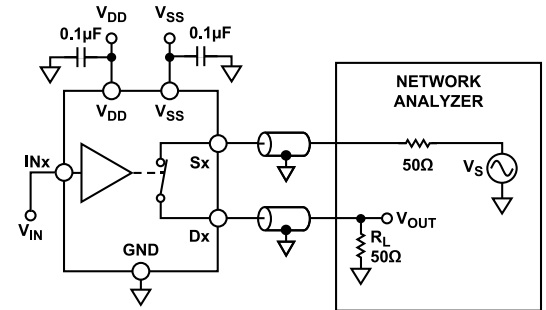

Figure 35. THD + Noise



$$\text{INSERTION LOSS} = 20 \log \frac{V_{OUT \text{ WITH SWITCH}}}{V_{OUT \text{ WITHOUT SWITCH}}}$$

Figure 36. Bandwidth

TEST CIRCUITS

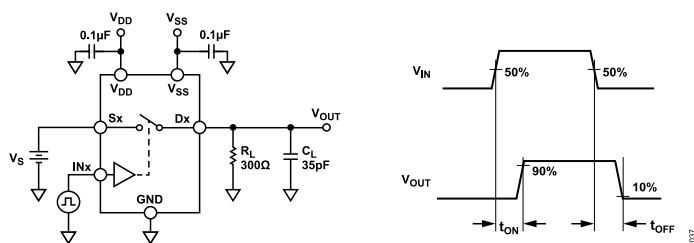

Figure 37. Switching Times

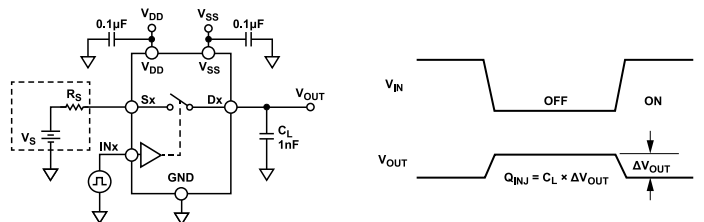

Figure 38. Charge Injection

TERMINOLOGY**I_{DD}**

The positive supply current.

I_{SS}

The negative supply current.

V_D and V_S

The analog voltage on Terminal D and Terminal S, respectively.

V_{TRACK}

The difference between V_S and V_D.

R_{ON}

The ohmic resistance between Terminal D and Terminal S.

ΔR_{ON}

The difference between the R_{ON} of any two channels.

R_{FLAT(ON)}

The difference between the maximum and minimum value of on resistance measured over the specified analog signal range.

I_S (Off)

The source leakage current with the switch off.

I_D (Off)

The drain leakage current with the switch off.

I_D (On) and I_S (On)

The channel leakage current with the switch on.

V_{INL}

The maximum input voltage for Logic 0.

V_{INH}

The minimum input voltage for Logic 1.

I_{INL} and I_{INH}

The input current of the digital input when high or when low.

C_S (Off) and C_D (Off)

The off switch source and drain capacitance for the off condition, which is measured with reference to ground.

C_D (On) and C_S (On)

The on switch drain and source capacitance for the on condition, which is measured with reference to ground.

C_{IN}

The digital input capacitance.

t_{ON}

The delay between applying the digital control input and the output switching on.

t_{OFF}

The delay between applying the digital control input and the output switching off.

t_D

The off-time measured between the 80% point of both switches when switching from one address state to another.

Off Isolation

A measure of unwanted signal coupling through an off switch.

Charge Injection

A measure of the glitch impulse transferred from the digital input to the analog output during switching.

Channel-to-Channel Crosstalk

A measure of unwanted signal that is coupled through from one channel to another as a result of parasitic capacitance.

Bandwidth

The frequency at which the output is attenuated by 3 dB.

On Response

The frequency response of the on switch.

Insertion Loss

The loss due to the on resistance of the switch.

Total Harmonic Distortion + Noise (THD + N)

The ratio of the harmonic amplitude plus noise of the signal to the fundamental.

AC Power Supply Rejection Ratio (AC PSRR)

The ratio of the amplitude of signal on the output to the amplitude of the modulation. This is a measure of the ability of the part to avoid coupling noise and spurious signals that appear on the supply voltage pin to the output of the switch. The DC voltage on the device is modulated by a sine wave of 0.62 V p-p.

THEORY OF OPERATIONS

SWITCH ARCHITECTURE

The ADG2412 contains four independent SPST, N-channel diffused metal-oxide semiconductor (NDMOS) switches, which allows for an excellent R_{ON} performance. Using an NDMOS only architecture results in a reduction of signal headroom, meaning signals are limited to $V_{DD} - 2$ V. To achieve the lowest on resistance, on-resistance flatness, and total harmonic distortion, it is recommended the signal stays less than $V_{DD} - 3.5$ V.

To guarantee correct operation of the ADG2412, a minimum of 0.1 μ F decoupling capacitors are required on both the V_{DD} and V_{SS} supply pins.

The ADG2412 is compatible with single-supply systems that have a V_{DD} of up to 16.5 V, dual-supply systems of up to ± 16.5 V, as well as asymmetric power supplies.

1.8 V LOGIC COMPATIBILITY

For ease of use, the ADG2412 does not have a V_L logic reference voltage. The digital inputs are compatible with 1.8 V logic levels over the full-operating supply range. The limits for 1.8 V logic are: $V_{INH} = 1.3$ V, $V_{INL} = 0.8$ V. 1.8 V logic-level inputs enable the ADG2412 to be compatible with processors that have lower supply rails, eliminating the need for an external translator.

If full 1.8 V and 1.2 V JEDEC compliance is required, refer to the Analog Devices, Inc., L range part numbers, such as the [ADG1412L](#).

APPLICATIONS INFORMATION

LARGE VOLTAGE, HIGH FREQUENCY SIGNAL TRACKING

Figure 26 shows the voltage range and corresponding frequencies that the ADG2412 can reliably convey. The tracking voltage (V_{TRACK}) in the figure shows the source voltage and the drain voltage difference, which is less than 50 mV for a given amplitude and frequency. For large voltage, high frequency signals, the frequency must be kept below 10 MHz. If the required frequency is greater than 10 MHz, decrease the signal range appropriately to ensure signal integrity.

POWER SUPPLY RECOMMENDATIONS

Analog Devices has a wide range of power management products to meet the requirements of high performance signal chains.

An example of a bipolar solution is shown in Figure 39. The LT3463 (a dual switching regulator), generates a positive and negative supply rail for the ADG2412, an amplifier, and/or a precision converter in a typical signal chain. Also, two optional low-dropout regulators (LDOs), the ADP7142 and the ADP7182 (positive and negative LDOs, respectively) are shown in Figure 39, which can reduce the output ripple of the LT3463 in ultra-low noise sensitive applications.

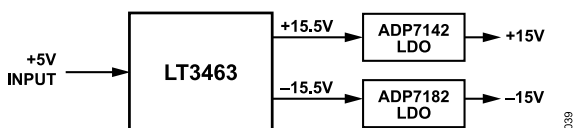

Figure 39. Bipolar Power Solution

Table 14. Recommended Power Management Devices

Product	Description
LT3463	Dual micropower, DC to DC converter with Schottky diodes
ADP7142	40 V, 200 mA, low noise, CMOS, LDO linear regulator
ADP7182	-28 V, -200 mA, low noise, LDO linear regulator

HIGH-CURRENT DRIVE AND PRECISION CURRENT-SENSE

Figure 40 shows an example application for the ADG2412. In automated test equipment (ATE) and instrumentation applications, when driving a current to a device under test (DUT), there is a requirement to have multiple sense resistors for multiple current ranges to facilitate large current output ranges from micro amps to amps. The low on-resistance of the ADG2412 is ideally suited to switching the force current output path in this application because it allows for high continuous current carrying as seen in Table 5 to Table 8.

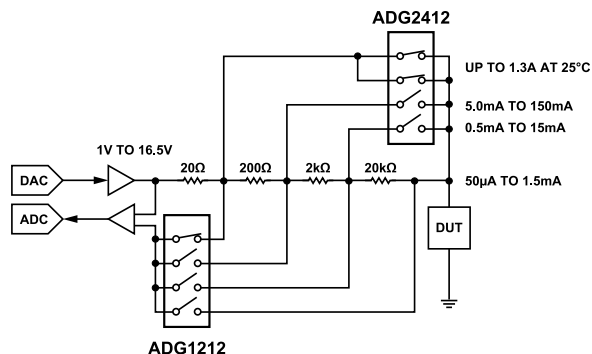

Figure 40. High-Current Drive and Precision Current-Sense Application

DIGITAL AUDIO CHANNEL TO ULTRA-LOW THD

Figure 41 shows an example application for the ADG2412. For precision audio signal chains, THD is a key specification. The THD performance of a switch is related to the on-resistance flatness, and the ADG2412 has exceptionally low on-resistance flatness of approximately 3 mΩ. Here, the ADG2412 is set up as a gain selection switch for an audio preamplifier to allow flexibility for the user to select multiple gain ranges. The THD performance of the ADG2412 maximizes the signal fidelity, and the low on-resistance minimizes any gain error in the system.

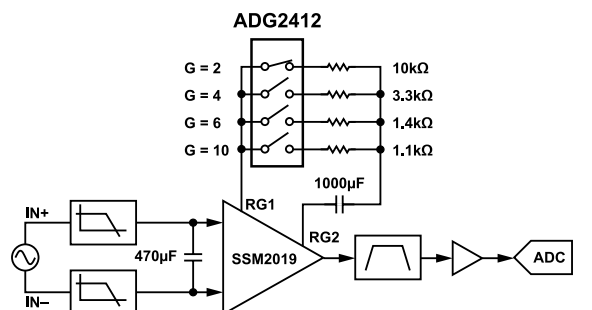

Figure 41. Digital Audio Channel to Ultra-Low THD Application