

FEATURES

- Complete rate gyroscope on a single chip**
- $\pm 300^\circ/\text{sec}$ angular rate sensing**
- High vibration rejection over a wide frequency range**
- Excellent $25^\circ/\text{hour}$ null offset stability**
- 2000 g powered shock survivability**
- SPI digital output with 16-bit data-word**
- Low noise and low power**
- 3.3 V and 5 V operation**
- -40°C to $+105^\circ\text{C}$ operation**
- Ultrasmall, light, and RoHS compliant**
- Two package options**
 - Low cost SOIC_CAV package for yaw rate (Z-axis) response**
 - Innovative ceramic vertical mount package, which can be oriented for pitch, roll, or yaw response**

APPLICATIONS

- Rotation sensing medical applications**
- Rotation sensing industrial and instrumentation**
- High performance platform stabilization**

GENERAL DESCRIPTION

The ADXRS450 is an angular rate sensor (gyroscope) intended for industrial, medical, instrumentation, stabilization, and other high performance applications. An advanced, differential, quad sensor design rejects the influence of linear acceleration, enabling the ADXRS450 to operate in exceedingly harsh environments where shock and vibration are present.

The ADXRS450 uses an internal, continuous self-test architecture. The integrity of the electromechanical system is checked by applying a high frequency electrostatic force to the sense structure to generate a rate signal that can be differentiated from the baseband rate data and internally analyzed.

The ADXRS450 is capable of sensing angular rate of up to $\pm 300^\circ/\text{sec}$. Angular rate data is presented as a 16-bit word, as part of a 32-bit SPI message.

The ADXRS450 is available in a cavity plastic 16-lead SOIC (SOIC_CAV) and an SMT-compatible vertical mount package (LCC_V), and is capable of operating across both a wide voltage range (3.3 V to 5 V) and temperature range (-40°C to $+105^\circ\text{C}$).

FUNCTIONAL BLOCK DIAGRAM



Figure 1.

Rev. C

[Document Feedback](#)

Information furnished by Analog Devices is believed to be accurate and reliable. However, no responsibility is assumed by Analog Devices for its use, nor for any infringements of patents or other rights of third parties that may result from its use. Specifications subject to change without notice. No license is granted by implication or otherwise under any patent or patent rights of Analog Devices. Trademarks and registered trademarks are the property of their respective owners.

One Technology Way, P.O. Box 9106, Norwood, MA 02062-9106, U.S.A.
 Tel: 781.329.4700 ©2011–2013 Analog Devices, Inc. All rights reserved.
[Technical Support](#) www.analog.com

TABLE OF CONTENTS

Features	1	Mechanical Considerations for Mounting.....	10
Applications.....	1	Applications Circuits	10
General Description	1	ADXRS450 Signal Chain Timing.....	10
Functional Block Diagram	1	SPI Communication Protocol.....	12
Revision History	2	Command/Response	12
Specifications.....	3	SPI Communications Characteristics.....	13
Absolute Maximum Ratings.....	4	SPI Applications	14
Thermal Resistance	4	SPI Rate Data Format.....	19
Rate Sensitive Axis	4	Memory Map and Registers	20
ESD Caution.....	4	Memory Map	20
Pin Configuration and Function Descriptions.....	5	Memory Register Definitions	21
Typical Performance Characteristics	7	Package Orientation and Layout Information.....	23
Theory of Operation	9	Package Marking Codes	25
Continuous Self-Test.....	9	Outline Dimensions	26
Applications Information	10	Ordering Guide	27

REVISION HISTORY

5/13—Rev. B to Rev. C

Changes to Features Section.....	1
Changed Null Accuracy from $\pm 3^\circ/\text{sec}$ to $\pm 6^\circ/\text{sec}$	3
Deleted Figure 6 from Low-Pass Filter Cut-Off (-3 dB) Frequency Test Conditions/Comments and Figure 7 from ST Low-Pass Filter -3 dB Frequency Test Conditions/Comments....	3
Changes to Figure 6, Figure 7, and Figure 11	7
Deleted Figure 10; Renumbered Sequentially.....	7
Deleted Figure 13 and Figure 15.....	8
Added Figure 12; Renumbered Sequentially	8
Changes to Figure 13 and Figure 15.....	8
Deleted Calibrated Performance Section	10
Changes to Applications Circuits Section	11
Changes to Figure 25.....	18
Changed Heading in Table 14 to 16-Bit Rate Data	19
Updated Outline Dimensions	26

12/11—Rev. A to Rev. B

Changes to the Rate Sensitive Axis Section	4
Changes to Figure 5.....	6
Changes to Figure 28.....	23
Deleted Figure 31, Renumbered Sequentially.....	24
Changes to Back Side Terminals Notation, Figure 34	26

6/11—Rev. 0 to Rev. A

Changes to Ordering Guide	28
---------------------------------	----

1/11—Revision 0: Initial Version

SPECIFICATIONS

Specification conditions @ $T_A = T_{MIN}$ to T_{MAX} , $P_{DD} = 5$ V, angular rate = $0^\circ/\text{sec}$, bandwidth = 80 Hz ± 1 g, continuous self-test on.

Table 1.

Parameter	Test Conditions/Comments	Symbol	Min	Typ	Max	Unit
MEASUREMENT RANGE	Full-scale range	FSR	± 300		± 400	$^\circ/\text{sec}$
SENSITIVITY	See Figure 2			80		LSB/ $^\circ/\text{sec}$
Nominal Sensitivity				± 3		%
Sensitivity Tolerance				0.05	0.25	% FSR rms
Nonlinearity ¹	Best fit straight line			± 3		%
Cross Axis Sensitivity ²						
NULL						
Null Accuracy				± 6		$^\circ/\text{sec}$
NOISE PERFORMANCE						
Rate Noise Density	$T_A = 25^\circ\text{C}$			0.015		$^\circ/\text{sec}/\sqrt{\text{Hz}}$
LOW-PASS FILTER						
Cut-Off (-3 dB) Frequency	$f_0/200$	f_{LP}		80		Hz
Group Delay ³	$f = 0$ Hz	t_{LP}	3.25	4	4.75	ms
SHOCK AND VIBRATION IMMUNITY						
Sensitivity to Linear Acceleration	DC to 5 kHz			0.03		$^\circ/\text{sec}/g$
Vibration Rectification				0.003		$^\circ/\text{sec}/g^2$
SELF TEST	See Continuous Self-Test section					
Magnitude				2559		LSB
Fault Register Threshold	Compared to LOCST data		2239		2879	LSB
Sensor Data Status Threshold	Compared to LOCST data		1279		3839	LSB
Frequency	$f_0/32$	f_{ST}		500		Hz
ST Low-Pass Filter						
-3 dB Frequency	$f_0/800$			2		Hz
Group Delay ³			52	64	76	ms
SPI COMMUNICATIONS						
Clock Frequency					8.08	MHz
Voltage Input High	MOSI, \overline{CS} , SCLK		$0.85 \times P_{DD}$		$P_{DD} + 0.3$	V
Voltage Input Low	MOSI, \overline{CS} , SCLK		-0.3		$P_{DD} \times 0.15$	V
Output Voltage Low	MISO, current = 3 mA				0.5	V
Output Voltage High	MISO, current = -2 mA		$P_{DD} - 0.5$			V
Pull-Up Current	\overline{CS} , $P_{DD} = 3.3$ V, $\overline{CS} = 0.75 \times P_{DD}$			50	200	μA
	\overline{CS} , $P_{DD} = 5$ V, $\overline{CS} = 0.75 \times P_{DD}$			70	300	μA
MEMORY REGISTERS	See the Memory Register Definitions section					
Temperature Sensor						
Value at 45°C				0		LSB
Scale Factor				5		LSB/ $^\circ\text{C}$
Quad, ST, Rate, DNC Registers						
Scale Factor				80		LSB/ $^\circ/\text{sec}$
POWER SUPPLY						
Supply Voltage		P_{DD}	3.15		5.25	V
Quiescent Supply Current		I_{DD}		6.0	10.0	mA
Turn-On Time	Power on to $0.5^\circ/\text{sec}$ of final			100		ms
TEMPERATURE RANGE	Independent of package type	T_{MIN} , T_{MAX}	-40		$+105$	$^\circ\text{C}$

¹ Maximum limit is guaranteed through Analog Devices, Inc., characterization.

² Cross axis sensitivity specification does not include effects due to device mounting on a printed circuit board (PCB).

³ Minimum and maximum limits are guaranteed by design.

ABSOLUTE MAXIMUM RATINGS

Table 2.

Parameter	Rating
Acceleration (Any Axis, 0.5 ms)	
Unpowered	2000 g
Powered	2000 g
Supply Voltage (P _{DD})	-0.3 V to +6.0 V
Output Short-Circuit Duration (Any Pin to Ground)	Indefinite
Temperature Range	
Operating	
LCC_V Package	-40°C to +125°C
SOIC_CAV Package	-40°C to +125°C
Storage	
LCC_V Package	-65°C to +150°C
SOIC_CAV Package	-40°C to +150°C

Stresses above those listed under Absolute Maximum Ratings may cause permanent damage to the device. This is a stress rating only; functional operation of the device at these or any other conditions above those indicated in the operational section of this specification is not implied. Exposure to absolute maximum rating conditions for extended periods may affect device reliability.

THERMAL RESISTANCE

θ_{JA} is specified for the worst-case conditions, that is, for a device soldered in a printed circuit board (PCB) for surface-mount packages.

Table 3. Thermal Resistance

Package Type	θ_{JA}	θ_{JC}	Unit
16-Lead SOIC_CAV	191.5	25	°C/W
14-Lead Ceramic LCC_V	185.5	23	°C/W

RATE SENSITIVE AXIS

The ADXRS450 is available in two package options. The SOIC_CAV package configuration is for applications that require a z-axis (yaw) rate sensing device.

The vertical mount package (LCC_V) option is for applications that require rate sensing in the axes parallel to the plane of the PCB (pitch and roll). See Figure 2 for details.

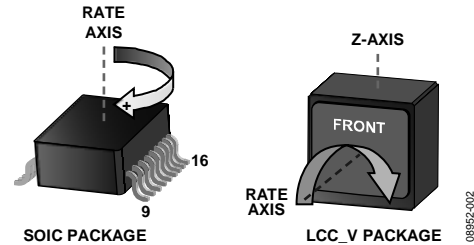

Figure 2. Rate Signal Increases with Clockwise Rotation

The LCC_V package has terminals on two faces; however, the terminals on the back side are for internal evaluation only and should not be used in the end application. The terminals on the bottom of the package incorporate metallization bumps that ensure a minimum solder thickness for improved solder joint reliability. These bumps are not present on the back side terminals and, therefore, poor solder joint reliability can be encountered if used in the end application. See Figure 32 in the Outline Dimensions section for a schematic of the LCC_V package.

ESD CAUTION



ESD (electrostatic discharge) sensitive device. Charged devices and circuit boards can discharge without detection. Although this product features patented or proprietary protection circuitry, damage may occur on devices subjected to high energy ESD. Therefore, proper ESD precautions should be taken to avoid performance degradation or loss of functionality.

PIN CONFIGURATION AND FUNCTION DESCRIPTIONS

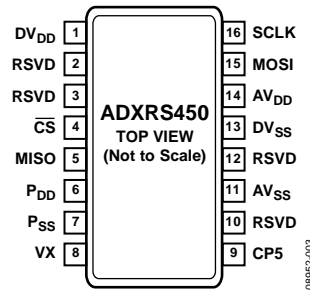

Figure 3. SOIC_CAV Pin Configuration

Table 4. 14-Lead SOIC_CAV Pin Function Descriptions

Pin No.	Mnemonic	Description
1	DV _{DD}	Digital Regulated Voltage. See Figure 19 for the applications circuit diagram.
2	RSVD	Reserved. This pin must be connected to DV _{SS} .
3	RSVD	Reserved. This pin must be connected to DV _{SS} .
4	$\overline{\text{CS}}$	Chip Select.
5	MISO	Master In/Slave Out.
6	P _{DD}	Supply Voltage.
7	P _{SS}	Switching Regulator Ground.
8	VX	High Voltage Switching Node. See Figure 19 for the applications circuit diagram.
9	CP5	High Voltage Supply. See Figure 19 for the applications circuit diagram.
10	RSVD	Reserved. This pin must be connected to DV _{SS} .
11	AV _{SS}	Analog Ground.
12	RSVD	Reserved. This pin must be connected to DV _{SS} .
13	DV _{SS}	Digital Signal Ground.
14	AV _{DD}	Analog Regulated Voltage. See Figure 19 for the applications circuit diagram.
15	MOSI	Master Out/Slave In.
16	SCLK	SPI Clock.

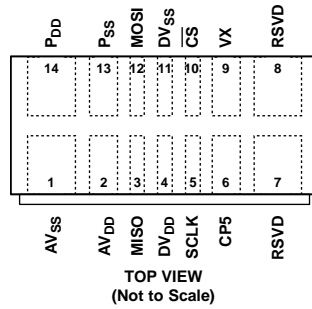
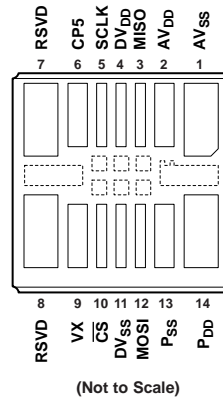

Figure 4. LCC_V Pin Configuration



NOTES

1. THE LCC_V PACKAGE HAS TWO TERMINALS ON TWO FACES; HOWEVER, THE TERMINALS ON THE BACK SIDE ARE FOR INTERNAL EVALUATION ONLY AND SHOULD NOT BE USED IN THE END APPLICATION. THE TERMINALS ON THE BOTTOM OF THE PACKAGE INCORPORATE METALLIZATION BUMPS THAT ENSURE A MINIMUM SOLDER THICKNESS FOR IMPROVED SOLDER JOINT RELIABILITY. THESE BUMPS ARE NOT PRESENT ON THE BACK SIDE TERMINALS AND, THEREFORE, POOR SOLDER JOINT RELIABILITY CAN BE ENCOUNTERED IF USED IN THE END APPLICATION. SEE THE OUTLINE DIMENSIONS SECTION FOR A SCHEMATIC OF THE LCC_V PACKAGE.

Figure 5. LCC_V Pin Configuration, Horizontal Layout

Table 5. 14-Lead LCC_V Pin Function Descriptions

Pin No.	Mnemonic	Description
1	AV _{SS}	Analog Ground.
2	AV _{DD}	Analog Regulated Voltage. See Figure 20 for the applications circuit diagram.
3	MISO	Master In/Slave Out.
4	DV _{DD}	Digital Regulated Voltage. See Figure 20 for the applications circuit diagram.
5	SCLK	SPI Clock.
6	CP5	High Voltage Supply. See Figure 20 for the applications circuit diagram.
7	RSVD	Reserved. This pin must be connected to DV _{SS} .
8	RSVD	Reserved. This pin must be connected to DV _{SS} .
9	VX	High Voltage Switching Node. See Figure 20 for the applications circuit diagram.
10	CS	Chip Select.
11	DV _{SS}	Digital Signal Ground.
12	MOSI	Master Out/Slave In.
13	P _{SS}	Switching Regulator Ground.
14	P _{DD}	Supply Voltage.

TYPICAL PERFORMANCE CHARACTERISTICS



Figure 6. SOIC_CAV Null Error @ 25°C

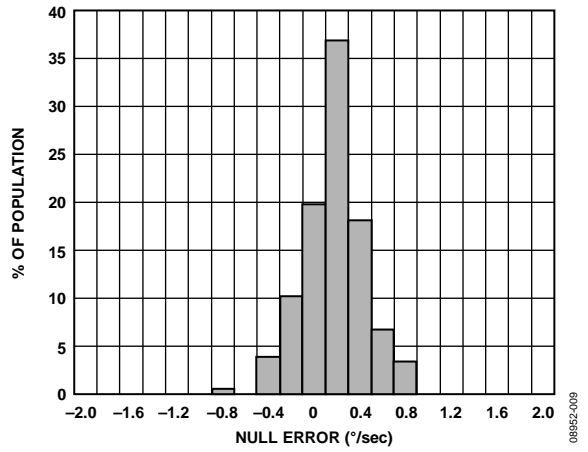

Figure 9. LCC_V Null Error @ 25°C



Figure 7. SOIC_CAV Null Temperature Coefficient

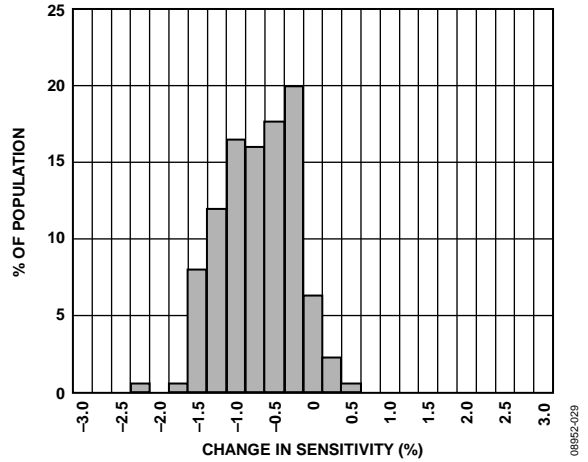

Figure 10. LCC_V Sensitivity Error @ 25°C



Figure 8. SOIC_CAV Sensitivity Error @ 25°C

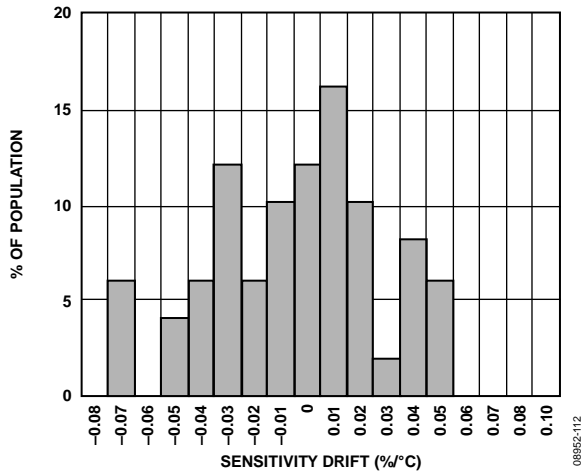

Figure 11. SOIC_CAV Sensitivity Drift over Temperature



Figure 12. DUT Typical Response to Random Vibration (5 Hz to 5 kHz at 15 g RMS)

08952-031

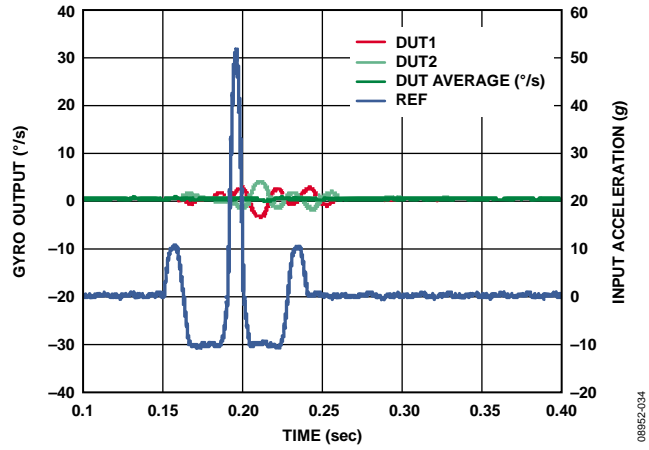

Figure 14. Typical Shock Response

08952-034



Figure 13. Null Drift over Temperature

08952-114

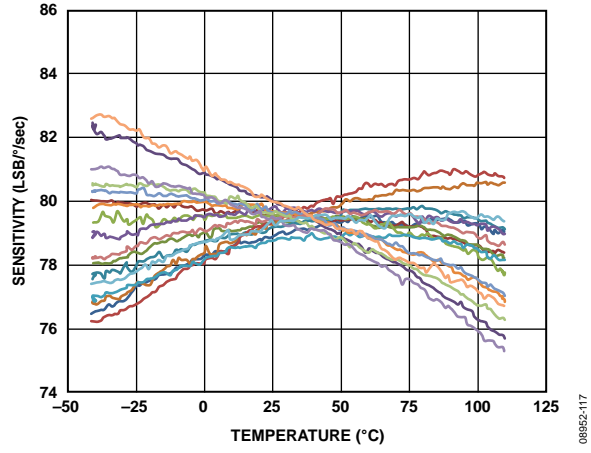

Figure 15. Sensitivity over Temperature

08952-117

THEORY OF OPERATION

The ADXRS450 operates on the principle of a resonator gyroscope. A simplified version of one of four polysilicon sensing structures is shown in Figure 16. Each sensing structure contains a dither frame that is electrostatically driven to resonance. This produces the necessary velocity element to produce a Coriolis force when experiencing angular rate. In the SOIC_CAV package, the ADXRS450 is designed to sense a z-axis (yaw) angular rate; whereas the vertical mount package (LCC_V) orients the device such that it can sense pitch or roll angular rate on the same PCB.

When the sensing structure is exposed to angular rate, the resulting Coriolis force couples into an outer sense frame, which contains movable fingers that are placed between fixed pickoff fingers. This forms a capacitive pickoff structure that senses Coriolis motion. The resulting signal is fed to a series of gain and demodulation stages that produce the electrical rate signal output. The quad sensor design rejects linear and angular acceleration, including external *g*-forces and vibration. This is achieved by mechanically coupling the four sensing structures such that external *g*-forces appear as common-mode signals that can be removed by the fully differential architecture implemented in the ADXRS450.



Figure 16. Simplified Gyroscope Sensing Structure

The resonator requires 22.5 V (typical) for operation. Because only 5 V is typically available in most applications, a switching regulator is included on chip.

CONTINUOUS SELF-TEST

The ADXRS450 gyroscope uses a complete electromechanical self-test. An electrostatic force is applied to the gyroscope frame, resulting in a deflection of the capacitive sense fingers. This deflection is exactly equivalent to deflection that occurs as a result of external rate input. The output from the beam structure is processed by the same signal chain as a true rate output signal, providing complete coverage of the electrical and mechanical components.

The electromechanical self-test is performed continuously during operation at a rate higher than the output bandwidth of the device. The self-test routine generates equivalent positive and negative rate deflections. This information can then be filtered with no overall effect on the demodulated rate output.



Figure 17. Continuous Self-Test Demodulation

The difference amplitude between the positive and negative self-test deflections is filtered to 2 Hz, and it is continuously monitored and compared to hardcoded self-test limits. If the measured amplitude exceeds these limits (listed in Table 1), one of two error conditions asserts depending on the magnitude of self-test error. For less severe self-test error magnitudes, the CST bit of the fault register is asserted; however, the status bits (ST[1:0]) in the sensor data response remain set to 0b01 for valid sensor data. For more severe self-test errors, the CST bit of the fault register is asserted, and the status bits (ST[1:0]) in the sensor data response are set to 0b00 for invalid sensor data. Table 1 lists the thresholds for both of these failure conditions. If desired, the user can access the self-test information by issuing a read command to the self-test memory register (Address 0x04). For more information about error reporting, see the SPI Communication Protocol section.

APPLICATIONS INFORMATION

MECHANICAL CONSIDERATIONS FOR MOUNTING

Mount the ADXRS450 in a location close to a hard mounting point of the PCB to the case. Mounting the ADXRS450 at an unsupported PCB location (that is, at the end of a lever, or in the middle of a trampoline), as shown in Figure 18, can result in apparent measurement errors because the gyroscope is subject to the resonant vibration of the PCB. Locating the gyroscope near a hard mounting point helps to ensure that any PCB resonances at the gyroscope are above the frequency at which harmful aliasing with the internal electronics can occur. To ensure that aliased signals do not couple into the baseband measurement range, design the module wherein the first system level resonance occurs at a frequency higher than 800 Hz.



Figure 18. Incorrectly Placed Gyroscope

APPLICATIONS CIRCUITS

Figure 19 and Figure 20 show the recommended application circuits for the ADXRS450 gyroscope. These application circuits provide a connection reference for the available package types. Note that DV_{DD}, AV_{DD}, and P_{DD} are individually connected to ground through 1 μF capacitors; do not connect these supplies together. Additionally, an external diode and inductor must be connected for proper operation of the internal shunt regulator. These components (listed in Table 6) allow for the internal resonator drive voltage to reach its required level, as listed in the Specifications section.

Table 6. Internal Shunt Regulator Components

Component	Qty.	Description
Inductor	1	470 μH
Diode	1	>24 V breakdown voltage
Capacitor	3	1 μF
Capacitor	1	100 nF

Note the following schematic recommendations:

- Keep leakage current on the CP5 pin to a minimum. All sources of leakage, including reverse leakage current through the diode and PCB surface leakage should account for not more than 70 μA. For most applications, the diode is the primary source of leakage current.
- Applications that operate at 3.3 V should use an inductor value of 560 μH to ensure proper operation of the internal boost regulator. For all applications, the inductor should be capable for 50 mA of peak current.



Figure 19. Recommended Applications Circuit, SOIC_CAV Package

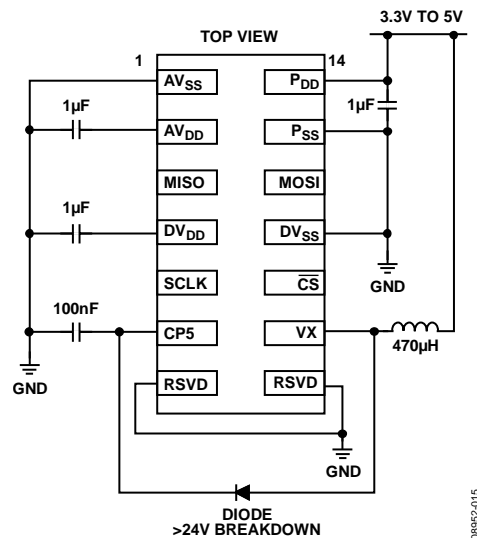

Figure 20. Recommended Applications Circuit, Ceramic LCC_V Package

ADXRS450 SIGNAL CHAIN TIMING

The ADXRS450 primary signal chain is shown in Figure 21; it is the series of necessary functional circuit blocks through which the rate data is generated and processed. This sequence of electro-mechanical elements determines how quickly the device is capable of translating an external rate input stimulus into an SPI word to be sent to the master device. The group delay, which is a function of the filter characteristic, is the time required for the output of the low-pass filter to be within 10% of the external rate input, and is seen to be ~4 ms. Additional delay can be observed due to the timing of SPI transactions and the population of the rate data into the internal device registers. Figure 21 anatomizes this delay, wherein the delay through each element of the signal chain is presented.

The transfer function for the rate data LPF is given as

$$\left[\frac{1 - Z^{-64}}{1 - Z^{-1}} \right]^2$$

where:

$$T = \frac{1}{f_0} = \frac{1}{16 \text{ kHz (typ)}}$$

The transfer function for the continuous self-test LPF is given as

$$\frac{1}{64 - 63Z^{-1}}$$

where:

$$T = \frac{16}{f_0} = 1 \text{ ms (typ)}$$



Figure 21. Primary Signal Chain and Associated Delays

08952-016

SPI COMMUNICATION PROTOCOL

COMMAND/RESPONSE

Input/output is handled through a 32-bit, command/response SPI interface. The command set and the format for the interface is defined as follows:

$$\text{Clock phase} = \text{clock polarity} = 0$$

Additionally, the device response to the initial command is 0x00000001. This prevents the transmission of random data to the master device upon the initial command/response exchange.

Table 7. SPI Signals

Signal	Symbol	Description
Serial Clock	SCLK	Exactly 32 clock cycles during $\overline{\text{CS}}$ active
Chip Select	$\overline{\text{CS}}$	Active low
Master Out Slave In	MOSI	Data sent to the gyroscope device from the main controller
Master In Slave Out	MISO	Data sent to the main controller from the gyroscope



Figure 22. SPI Protocol

Table 8. SPI Commands

Command	Bit																																
	31	30	29	28	27	26	25	24	23	22	21	20	19	18	17	16	15	14	13	12	11	10	9	8	7	6	5	4	3	2	1	0	
Sensor Data	SQ1	SQ0	1	SQ2																												CHK	P
Read	1	0	0	SM2	SM1	SM0	A8	A7	A6	A5	A4	A3	A2	A1	A0																		P
Write	0	1	0	SM2	SM1	SM0	A8	A7	A6	A5	A4	A3	A2	A1	A0	D15	D14	D13	D12	D11	D10	D9	D8	D7	D6	D5	D4	D3	D2	D1	D0	P	

Table 9. SPI Responses

Command	Bit																																
	31	30	29	28	27	26	25	24	23	22	21	20	19	18	17	16	15	14	13	12	11	10	9	8	7	6	5	4	3	2	1	0	
Sensor Data	SQ2	SQ1	SQ0	P0	ST1	ST0	D15	D14	D13	D12	D11	D10	D9	D8	D7	D6	D5	D4	D3	D2	D1	D0				PLL	Q	NVM	POR	PWR	CST	CHK	P1
Read	0	1	0	P0	1	1	1	0	SM2	SM1	SM0	D15	D14	D13	D12	D11	D10	D9	D8	D7	D6	D5	D4	D3	D2	D1	D0						P1
Write	0	0	1	P0	1	1	1	0	SM2	SM1	SM0	D15	D14	D13	D12	D11	D10	D9	D8	D7	D6	D5	D4	D3	D2	D1	D0						P1
R/W Error	0	0	0	P0	1	1	1	0	SM2	SM1	SM0	0	0	SPI	RE	DU										PLL	Q	NVM	POR	PWR	CST	CHK	P1

SPI COMMUNICATIONS CHARACTERISTICS

Note the following conditions for Table 10:

- All minimum and maximum timing values are guaranteed through characterization.
- All timing is shown with respect to 10% V_{DD} and 90% of the actual delivered voltage waveform.
- All minimum and maximum timing values are valid for $3.0\text{ V} \leq V_{DD} \leq 5.5\text{ V}$.
- Capacitive load for all signals is assumed to be $\leq 80\text{ pF}$.
- Ambient temperature is $-40^{\circ}\text{C} \leq T_A \leq +105^{\circ}\text{C}$.
- MISO pull-up of $47\text{ k}\Omega$ or $110\text{ }\mu\text{A}$.
- Sequential transfer increases to 17 ms following any write operation limited by the EEPROM.

Table 10. SPI Command/Response Timing Characteristics

Symbol	Description	Min	Max	Unit
f_{OP}	SPI operating frequency		8.08	MHz
t_{SCLKH}	Clock (SCLK) high time	$1/2t_{SCLK} - 13$		ns
t_{SCLKL}	Clock (SCLK) low time	$1/2t_{SCLK} - 13$		ns
t_{SCLK}	SCLK period	123.7		ns
t_F	Clock (SCLK) fall time	5.5	13	ns
t_R	Clock (SCLK) rise time	5.5	13	ns
t_{SU}	Data input (MOSI) setup time	37		ns
t_{HIGH}	Data input (MOSI) hold time	49		ns
t_A	Data output (MISO) access time		20	ns
t_V	Data output (MISO) valid after SCLK		20	ns
t_{LAG}	Data output (MISO) lag time	0		ns
t_{DIS}	Data output (MISO) disable time		40	ns
t_{LEAD}	Enable (\overline{CS}) lead time	$1/2t_{SCLK}$		ns
t_{LAG}	Enable (\overline{CS}) lag time	$1/2t_{SCLK}$		ns
t_D	Sequential transfer delay	0.1		ms
f_0	Gyroscope resonant frequency	13	19	kHz

SPI APPLICATIONS

Device Data Latching

To allow for rapid acquisition of data from the ADXRS450, device data latching has been implemented in the design, as shown in Figure 24. Upon the assertion of chip select (\overline{CS}), the data present in the device is latched into memory. When the full MOSI command has been received, and \overline{CS} deasserted, the

appropriate data is shifted into the SPI port registers in preparation for the next sequential command/response exchange. This allows for an exceedingly fast sequential transfer delay of 0.1 ms (see Table 10). As a design precaution, note that the transmitted data is only as recent as the sequential transmission delay implemented by the system. Conditions that result in a sequential transfer delay of several seconds cause the next sequential device response to contain data that is several seconds old.



Figure 23. SPI Timings



Figure 24. Device Data Latching

Command/Response—Bit Definitions**Table 11. Quick Guide—Bit Definitions for SPI Interface**

Bit	Description
SQ2 to SQ0	Sequence bits (from master)
SM2 to SM0	Sensor module bits (from master)
A8 to A0	Register address
D15 to D0	Data
SPI	SPI command/response
ST1 to ST0	Status bits
P	Command odd parity
P0	Response, odd parity, Bits[31:16]
P1	Response, odd parity, Bits[31:0]
RE	Request error
DU	Data unavailable

SQ2 to SQ0

This field provides the system with a means of synchronizing the data samples that are received from multiple sensors. To facilitate correct synchronization, the ADXRS450 gyroscope includes the SQ[2:0] field in the response sequence as it was received in the request.

SM2 to SM0

Sensor module bits from master device. These bits have not been implemented in the ADXRS450, and are hardcoded to be 000 for all occurrences.

A8 to A0

The A8 to A0 bits represent the memory address from which device data is being read, or to which information is to be written. These bits should only be supplied by the master when the memory registers are being accessed, and are ignored for all sensor data requests. Refer to the Memory Register Definitions section for a complete description of the available memory registers.

D15 to D0

16-bit device data that can contain any of the following:

- Master—data to be written to a memory register as specified in the A8 to A0 section.
- Slave—sensor rate output data.
- Slave—device data read from the memory register specified in the A8 to A0 section, as well as the data from the next sequential register.
- Slave—for a write command, the 16-bit data that is written to the specified memory register reflects back to the master device for correlation.

SPI

The SPI bit sets when any of the following occurs: either too many/not enough bits are transmitted, or the message from the control module contains a parity error. Additionally, any error during a sensor data request results in the device issuing a read/write error.

ST1 to ST0

The status bits (ST1 and ST0) are used to signal to the master device the type of data contained in the response message. The status bits are decoded as listed in Table 12.

Table 12. Status Bit Code Definitions

ST1:ST0	Content in Bits[D15:D0]
00	Error data for sensor data response
01	Valid sensor data
10	Sensor self-test data
11	Read/write response

There are two independent conditions that can result in the ST bits being set to 0b00 during a sensor data response: self-test or PLL. The self-test response is sufficiently different from its nominal value. Refer to the Specifications section for the appropriate limits. When the sensor data response is a PLL, the PLL fault is active.

P

A parity bit (P) is required for all master-to-slave data transmissions. Communications protocol requires one parity bit to achieve odd parity for the entire 32-bit command. Bits that are in don't care positions remain factored into the parity calculation.

P0

P0 is the parity bit that establishes odd parity for Bits[31:16] of the device response.

P1

P1 is the parity bit that establishes odd parity for the entire 32-bit device response.

RE

RE is the communications error bit transmitted from the ADXRS450 device to the control module. Request errors (RE) can occur when

- An invalid command is sent from the control module.
- The read/write command specifies an invalid memory register.
- The write command attempted to a nonwriteable memory register.

DU

As expressed in Table 10, the sequential transfer delay for writing data to a memory register (for example, DNC0) results in a sequential transfer delay of 0.1 ms. If a successive write command is issued to the device prior to the completion of the sequential transfer delay, the command is ignored and the device issues a data unavailable (DU) error response. However, a read command or sensor data request can be issued after a sequential transfer delay of only 10 μ s is observed. Regardless of the commands that are subsequently issued to the device, when a write procedure has been initiated, the operation proceeds through to completion (requiring 17 ms).

Fault Register Bit Definitions

This section describes the bits available for signaling faults to the user. The individual bits of the fault register are updated asynchronously depending on their respective detection criteria; however, it is recommended that the fault register be read at a rate of at least 250 Hz. When asserted, the individual status bit does not deassert until it is read by the master device. If the error persists after a fault register read, the status bit immediately reasserts, and remains asserted until the next sequential command/response exchange. The full fault register is appended to every sensor data request. It can also be accessed by issuing a read command to Register 0x0A.

Table 13. Quick Guide—Fault Register Bit Definitions

Bit Name	Description
PLL	PLL failure
Q	Quadrature error
NVM	Nonvolatile memory fault (NVM)
POR	Power-on reset failed to initialize
UV	Regulator undervoltage
Amp	Amplitude detection failure
PWR	Power regulation failed: overvoltage/undervoltage
CST	Continuous self-test failure
CHK	Check: generate faults
OV	Regulator overvoltage
Fail	Failure that sets the ST[1:0] bits to 0b00

PLL

PLL is the bit indicating that the device has had a failure in the phase-locked loop functional circuit block. This occurs when the PLL has failed to achieve sync with the resonator structure. If the PLL status flag is active, the ST bits of the sensor data response are set to 0b00, indicating that the response contains potentially invalid rate data.

Q

A Q fault can be asserted based on two independent quadrature calculations. Located in the quad memory (Register 0x08) is a value corresponding to the total instantaneous quadrature present in the device. If this value exceeds 4096 LSB, a Q fault is issued. Because quadrature build-up can contribute to an offset error, the ADXRS450 has integrated methods for dynamically cancelling the effects of quadrature. An internal quadrature accumulator records the amount of quadrature correction performed by the ADXRS450. Excessive quadrature is associated with offset errors. A Q fault is issued when the quadrature error (Q) present in the device has contributed to an equivalent of 4°/sec (typical) of rate offset.

NVM

An NVM error transmits to the control module when the internal NVM data fails a checksum calculation. This check is performed once every 50 μs, and does not include the DNC0 or PID memory registers.

POR

An internal check is performed at the time of device startup to ensure that the volatile memory of the device is functional. This is accomplished by programming a known value from the device ROM into a volatile memory register. This value is then continuously compared to the known value in ROM every 1 μs for the duration of device operation. If the value stored in the volatile memory changes, or does not match the value stored in ROM, the POR error flag is asserted. The value stored in ROM is rewritten to the volatile memory upon a device power cycle.

PWR

The device performs a continuous check of the internal 3 V regulated voltage level. If either an overvoltage (OV) or undervoltage (UV) fault is asserted, then the power (PWR) bit is also asserted. This condition occurs if the regulated voltage is observed to be either above 3.3 V or below 2.77 V. An internal low-pass filter removes high frequency glitching effects to prevent the PWR bit from asserting unnecessarily. To determine if the fault is a result of an overvoltage or undervoltage condition, the OV and UV fault bits must be analyzed.

CST

The ADXRS450 is designed with continuous self-test (CST) functionality. Measured self-test amplitudes are compared against the limits presented in Table 1. Deviations from this value are what result in reported self-test errors. There are two thresholds for a self-test failure.

- Self-test value > ±512 LSB from nominal results in an assertion of the self-test flag in the fault register.
- Self-test value > ±1856 LSB from nominal results in both an assertion of the self-test flag in the fault register as well as setting the ST[1:0] bits to 0b00, indicating that the rate data contained in the sensor data response is potentially invalid.

CHK

The control module transmits the check (CHK) bit to the ADXRS450 as a method of generating faults. By asserting the CHK bit, the device creates conditions that result in the generation of all faults represented through the fault register. For example, the self-test amplitude is deliberately altered to exceed the fault detection threshold, resulting in a self-test error. In this way, the device is capable of checking both its ability to detect a fault condition, as well as its ability to report that fault to the control module.

The fault conditions are initiated nearly simultaneously; however, the timing for receiving fault codes when the CHK bit is asserted is dependent upon the time required to generate each unique fault. It takes no more than 50 ms for all of the internal faults to be generated and for the fault register to be updated to reflect the condition of the device. Until the CHK bit is cleared, the status bits (ST[1:0]) are set to 0b10, indicating that the data should be interpreted by the control module as self-test data. After the CHK bit is deasserted, the fault conditions require an additional 50 ms to decay, and the device to return to normal operation.

OV

The overvoltage (OV) fault bit asserts if the internally regulated voltage (nominally 3 V) is observed to exceed 3.3 V. This measurement is low-pass filtered to prevent artifacts such as noise spikes from asserting a fault condition. When an OV fault has occurred, the PWR fault bit is asserted simultaneously. Because the OV fault bit is not transmitted as part of a sensor data request, it is recommended that the user read back the FAULT1 and FAULT0 memory registers upon the assertion of a PWR error. This allows the user to determine the specific error condition.

UV

The undervoltage (UV) fault bit asserts if the internally regulated voltage (nominally 3 V) is observed to be less than 2.77 V. This measurement is low-pass filtered to prevent artifacts such as noise spikes from asserting a fault condition. When a UV fault has occurred, the PWR fault bit is asserted simultaneously. As the UV fault bit is not transmitted as part of a sensor data request, it is recommended that the user read back the FAULT1 and FAULT0 memory registers upon the assertion of a PWR error. This allows the user to determine the specific error condition.

Fail

The fail flag is asserted when a condition arises such that the ST[0:1] bits are set to 0b00. This indicates that the device has experienced a gross failure, and that the sensor data could potentially be invalid.

Amp

The amp fault bit is asserted when the measured amplitude of the silicon resonator has been significantly reduced. This condition can occur if the voltage supplied to CP5 has fallen below the requirements of the internal voltage regulator. This fault bit is OR'ed with the CST fault such that during a sensor data request, the CST bit position represents either an amp failure or a CST failure. The full status register can then be read from memory to validate the specific failure.

K-Bit Assertion: Recommended Start-Up Routine

Figure 25 illustrates a recommended start-up routine that can be implemented by the user. Alternate start-up sequences can be employed; however, ensure that the response from the ADXRS450 is handled correctly. If implemented immediately after power is applied to the device, the total time to implement the following fault detection routine is approximately 200 ms.

As described in the Device Data Latching section, the data present in the device upon the assertion of the \overline{CS} signal is used in the next sequential command/response exchange. This results in an apparent one transaction delay before the data resulting from the assertion of the CHK command is reported by the device. For all other read/write interactions with the device, no such delay exists, and the MOSI command is serviced during the next sequential command/response exchange. Note that when the CHK bit is deasserted, if the user tries to obtain data from the device before the CST fault flag has cleared, the device reports the data as error data.

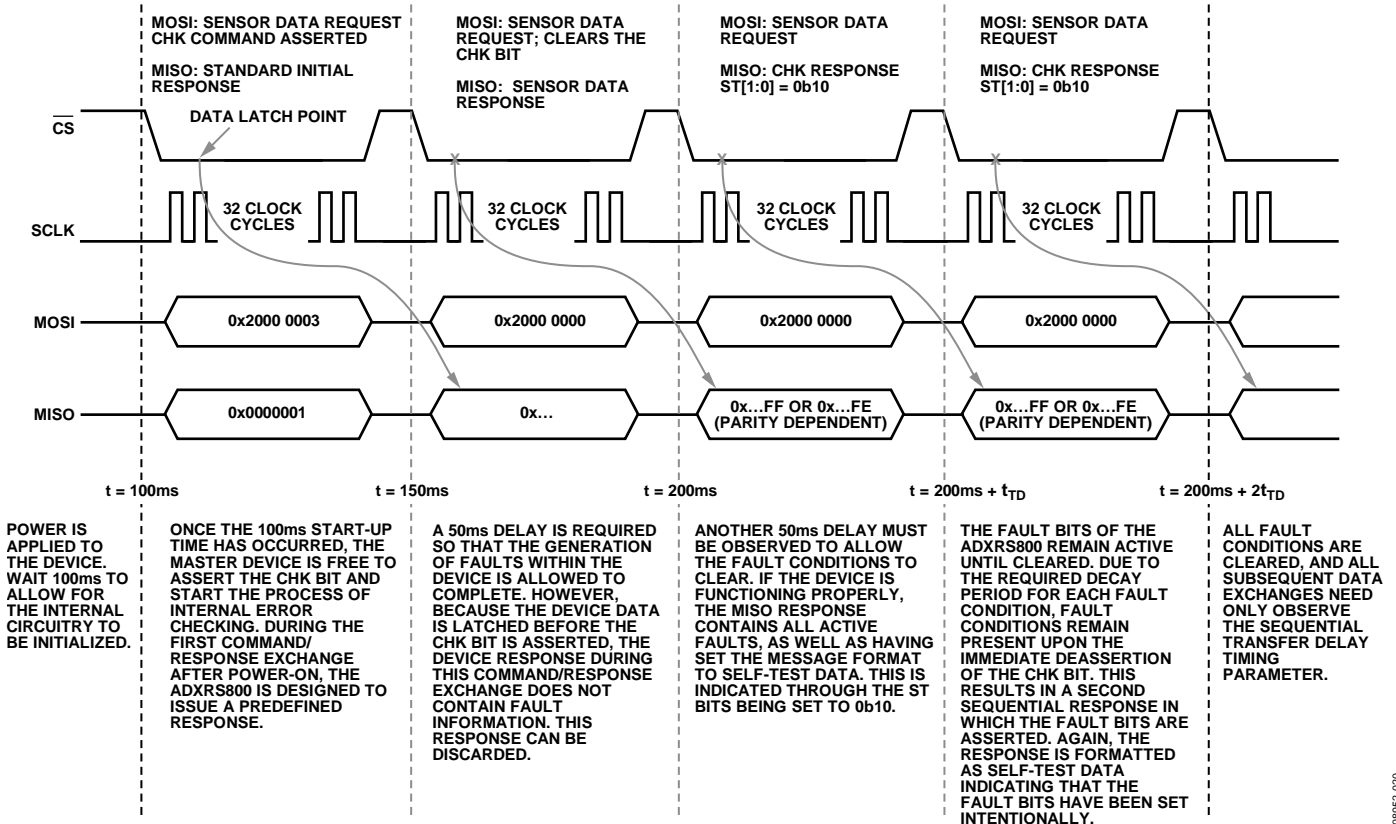

Figure 25. Recommended Start-Up Sequence

08952-020

SPI RATE DATA FORMAT

The ADXRS450 gyroscope transmits rate data in a 16-bit format, as part of a 32-bit SPI data frame. See Table 9 for the full 32-bit format of the sensor data request response. The rate data is transmitted MSB first, from D15 to D0. The data is formatted as a two's complement number, with a scale factor of 80 LSB/°/sec.

Therefore, the highest obtainable value for positive (clockwise) rotation is 0x7FFF (decimal +32,767), and for counterclockwise rotation is 0x8000 (decimal -32,768). Performance of the device is not guaranteed above $\pm 24,000$ LSB ($\pm 300^\circ/\text{sec}$).

Table 14. Rate Data

16-Bit Rate Data		Data Type	Description
Decimal (LSBs)	Hex (D15:D0)		
+32,767	0x7FFF	Rate data (not guaranteed)	Maximum possible positive data value
...
+24,000	0x5DC0	Rate data	+300 degrees per second rotation (positive FSR)
...
+160	0x00A0	Rate data	+2 degrees per second rotation
+80	0x0050	Rate data	+1 degree per second rotation
...
+40	0x0028	Rate data	+1/2 degree per second rotation
+20	0x0014	Rate data	+1/4 degree per second rotation
...
0	0x 0000	Rate data	Zero rotation value
...
-20	0xFFEC	Rate data	-1/4 degree per second rotation
-40	0xFFD8	Rate data	-1/2 degree per second rotation
...
-80	0xFFB0	Rate data	-1 degree per second rotation
-160	0xFF60	Rate data	-2 degree per second rotation
...
-24,000	0xA240	Rate data	-300 degree per second rotation (negative FSR)
...
-32,768	0x8000	Rate data (not guaranteed)	Maximum possible negative data value

MEMORY MAP AND REGISTERS

MEMORY MAP

The following is a list of the memory registers that are available to be read from or written to by the customer. See the previous section SPI Communication Protocol for the proper input sequence to read/write a specific memory register. Each memory register is comprised of eight bits of data, however, when a read request is performed, the data always returns as a 16-bit message. This is accomplished by appending the data

from the next, sequential register to the memory address that was specified. Data is transmitted MSB first. For proper acquisition of data from the memory register, make the read request to the even numbered register address only. Following the memory map (see Table 15) is the explanation of the significance of each memory register.

Table 15. Memory Register Map

Address	Register Name	MSB	D6	D5	D4	D3	D2	D1	LSB
0x00	RATE1	RTE15	RTE14	RTE13	RTE12	RTE11	RTE10	RTE9	RTE8
0x01	RATE0	RTE7	RTE6	RTE5	RTE4	RTE3	RTE2	RTE1	RTE0
0x02	TEM1	TEM9	TEM8	TEM7	TEM6	TEM5	TEM4	TEM3	TEM2
0x03	TEM0	TEM1	TEM0	(Unused)	(Unused)	(Unused)	(Unused)	(Unused)	(Unused)
0x04	LOCST1	LCST15	LCST14	LCST13	LCST12	LCST11	LCST10	LCST9	LCST8
0x05	LOCST0	LCST7	LCST6	LCST5	LCST4	LCST3	LCST2	LCST1	LCST0
0x06	HICST1	HCST15	HCST14	HCST13	HCST12	HCST11	HCST10	HCST9	HCST8
0x07	HICST0	HCST7	HCST6	HCST5	HCST4	HCST3	HCST2	HCST1	HCST0
0x08	QUAD1	QAD15	QAD14	QAD13	QAD12	QAD11	QAD10	QAD9	QAD8
0x09	QUAD0	QAD7	QAD6	QAD5	QAD4	QAD3	QAD2	QAD1	QAD0
0x0A	FAULT1	(Unused)	(Unused)	(Unused)	(Unused)	FAIL	AMP	OV	UV
0x0B	FAULT0	PLL	Q	NVM	POR	PWR	CST	CHK	0
0x0C	PID1	PIDB15	PIDB14	PIDB13	PIDB12	PIDB11	PIDB10	PIDB9	PIDB8
0x0D	PID0	PIDB7	PIDB6	PIDB5	PIDB4	PIDB3	PIDB2	PIDB1	PIDB0
0x0E	SN3	SNB31	SNB30	SNB29	SNB28	SNB27	SNB26	SNB25	SNB24
0x0F	SN2	SNB23	SNB22	SNB21	SNB20	SNB19	SNB18	SNB17	SNB16
0x10	SN1	SNB15	SNB14	SNB13	SNB12	SNB11	SNB10	SNB9	SNB8
0x11	SN0	SNB7	SNB6	SNB5	SNB4	SNB3	SNB2	SNB1	SNB0
0x12	DNC1	(Unused)	(Unused)	(Unused)	(Unused)	(Unused)	(Unused)	DNCB9	DNCB8
0x13	DNC0	DNCB7	DNCB6	DNCB5	DNCB4	DNCB3	DNCB2	DNCB1	DNCB0

MEMORY REGISTER DEFINITIONS

The SPI accessible memory registers are described in this section. As explained in the previous section, when requesting data from a memory register, only the first sequential memory address need be addressed. The data returned by the device contain 16 bits of memory register information. Bits[15:8] contain the MSB of the requested information, and Bits[7:0] contain the LSB.

Rate Registers

Addresses: 0x00 (RATE1)
0x01 (RATE0)

Register update rate: 500 Hz

Scale factor: 80 LSB/°/sec

The rate registers contain the temperature compensated rate output of the device filtered to 80 Hz. This data can also be accessed by issuing a sensor data read request to the device. The data is presented as a 16-bit, twos complement number.

MSB							LSB
D15	D14	D13	D12	D11	D10	D9	D8
D7	D6	D5	D4	D3	D2	D1	D0

Temperature (TEMx) Registers

Addresses: 0x02 (TEM1),
0x03 (TEM0)

Register update rate: 500 Hz

Scale factor: 5 LSB/°C

The TEM register contains a value corresponding to the temperature of the device. The data is presented as a 10-bit, twos complement number. 0 LSB corresponds to a temperature of approximately 45°C.

MSB							LSB
D9	D8	D7	D6	D5	D4	D3	D2
D1	D0	(Unused)					

Table 16.

Temperature	Value of TEM1:TEM0
45°C	0000 0000 00XX XXXX
85°C	0011 0010 00XX XXXX
0°C	1100 0111 11XX XXXX

Low CST (LOCST) Memory Registers

Addresses: 0x04 (LOCST1)
0x05 (LOCST0)

Register update rate: 1000 Hz

Scale factor: 80 LSB/°/sec

The LOCST memory registers contain the value of the temperature compensated and low-pass filtered continuous self-test delta. This value is a measure of the difference between the positive and negative self-test deflections and corresponds to the values presented in Table 1. The device issues a CST error if the value of self-test exceeds the established self-test limits. The self-test data is filtered to 2 Hz to prevent false triggering of the CST fault bit. The data is presented as a 16-bit, twos complement number, with a scale factor of 80 LSB/°/sec.

MSB							LSB
D15	D14	D13	D12	D11	D10	D9	D8
D7	D6	D5	D4	D3	D2	D1	D0

High CST (HICST) Memory Registers

Addresses: 0x06 (HICST1),
0x07 (HICST0)

Register update rate: 1000 Hz

Scale factor: 80 LSB/°/sec

The HICST register contains the unfiltered self-test information. The HICST data can be used to supplement fault diagnosis in safety critical applications as sudden shifts in the self-test response can be detected. However, the CST bit of the fault register is not set when the HICST data is observed to exceed the self-test limits. Only the LOCST memory registers, which are designed to filter noise and the effects of sudden temporary self-test spiking due to external disturbances, control the assertion of the CST fault bit. The data is presented as a 16-bit, twos complement number.

MSB							LSB
D15	D14	D13	D12	D11	D10	D9	D8
D7	D6	D5	D4	D3	D2	D1	D0

Quad Memory Registers

Addresses: 0x08 (QUAD1)
0x09 (QUAD0)

Register update rate: 250 Hz

Scale factor: 80 LSB/°/sec equivalent

The quad memory registers contain a value corresponding to the amount of quadrature error present in the device at a given time. Quadrature can be likened to a measurement of the error of the motion of the resonator structure, and can be caused by stresses and aging effects. The quadrature data is filtered to 80 Hz and can be read frequently to detect sudden shifts in the level of quadrature. The data is presented as a 16-bit, twos complement number.

MSB							LSB
D15	D14	D13	D12	D11	D10	D9	D8
D7	D6	D5	D4	D3	D2	D1	D0

Fault Registers

Addresses: 0x0A (FAULT1)
 0x0B (FAULT0)

Register update rate: Not applicable

Scale factor: Not applicable

The fault register contains the state of the error flags in the device. The FAULT0 register is appended to the end of every device data transmission (see Table 13); however, this register can also be accessed independently through its memory location. The individual fault bits are updated asynchronously, requiring <5 μs to activate, as soon as the fault condition exists on-chip. When toggled, each fault bit remains active until the fault register is read or a sensor data command is received. If the fault is still active after the bit is read, the fault bit immediately reasserts itself.

MSB				LSB			
(Unused)				FAIL	AMP	OV	UV
PLL	Q	NVM	POR	PWR	ST	CHK	0

Part ID (PID) Registers

Addresses: 0x0C (PID1)
 0x0D (PID0)

Register update rate: Not applicable

Scale factor: Not applicable

The part identification registers contain a 16-bit number identifying the version of the ADXRS450. Combined with the serial number, this information allows for a higher degree of device individualization and tracking. The initial product ID is R01 (0x5201), with subsequent versions of silicon incrementing this value to R02, R03, and so forth.

MSB							LSB
D15	D14	D13	D12	D11	D10	D9	D8
D7	D6	D5	D4	D3	D2	D1	D0

Serial Number (SN) Registers

Addresses: 0x0E (SN3)
 0x0F (SN2)
 0x10 (SN1)
 0x11 (SN0)

Register update rate: Not applicable

Scale factor: Not applicable

The serial number registers contain a 32-bit identification number that uniquely identifies the device. To read the entire serial number, two memory read requests must be initiated. The first read request to Register 0x0E returns the upper 16 bits of the serial number, and the following read request to Register 0x10 returns the lower 16 bits of the serial number.

MSB						LSB	
D31	D30	D29	D28	D27	D26	D25	D24
D23	D22	D21	D20	D19	D18	D17	D16
D15	D14	D13	D12	D11	D10	D9	D8
D7	D6	D5	D4	D3	D2	D1	D0

Dynamic Null Correction (DNC) Registers

Addresses: 0x12 (DNC1)
 0x13 (DNC0)

Register update rate: Not applicable

Scale factor: 80 LSB/°/sec

The dynamic null correction register is the only register with write access available to the user. The user can make small adjustments to the rateout of the device by asserting these bits. This 10-bit register allows the user to adjust the static rateout of the device by up to ±6.4°/sec.

MSB						LSB	
(Unused)						D9	D8
D7	D6	D5	D4	D3	D2	D1	D0

PACKAGE ORIENTATION AND LAYOUT INFORMATION

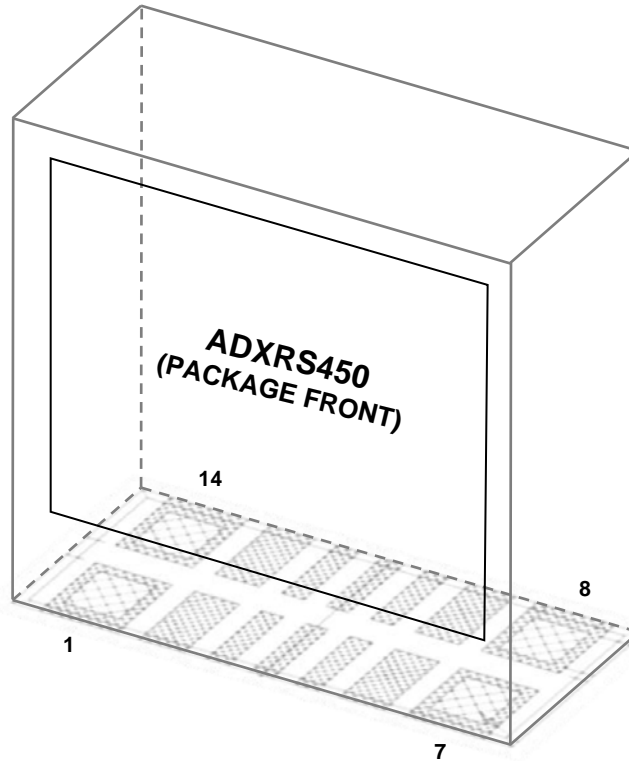

NOTES

1. THE LCC_V PACKAGE HAS TWO TERMINALS ON TWO FACES; HOWEVER, THE TERMINALS ON THE BACK SIDE ARE FOR INTERNAL EVALUATION ONLY AND SHOULD NOT BE USED IN THE END APPLICATION. THE TERMINALS ON THE BOTTOM OF THE PACKAGE INCORPORATE METALLIZATION BUMPS THAT ENSURE A MINIMUM SOLDER THICKNESS FOR IMPROVED SOLDER JOINT RELIABILITY. THESE BUMPS ARE NOT PRESENT ON THE BACK SIDE TERMINALS AND, THEREFORE, POOR SOLDER JOINT RELIABILITY CAN BE ENCOUNTERED IF USED IN THE END APPLICATION. SEE THE OUTLINE DIMENSIONS SECTION FOR A SCHEMATIC OF THE LCC_V PACKAGE.

08952-004

Figure 26. 14-Terminal Ceramic LCC_V Vertical Mount

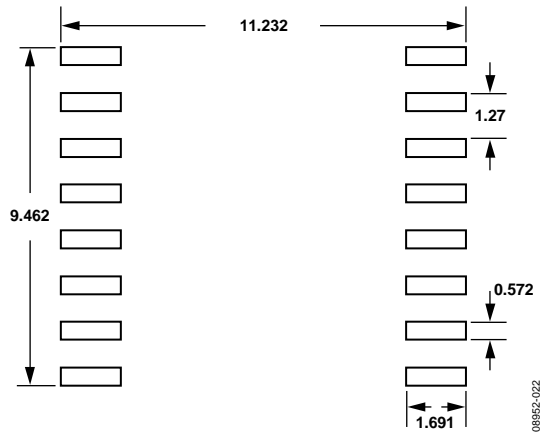

Figure 27. Sample SOIC_CAV Solder Pad Layout (Land Pattern), Dimensions Shown In Millimeters, Not To Scale

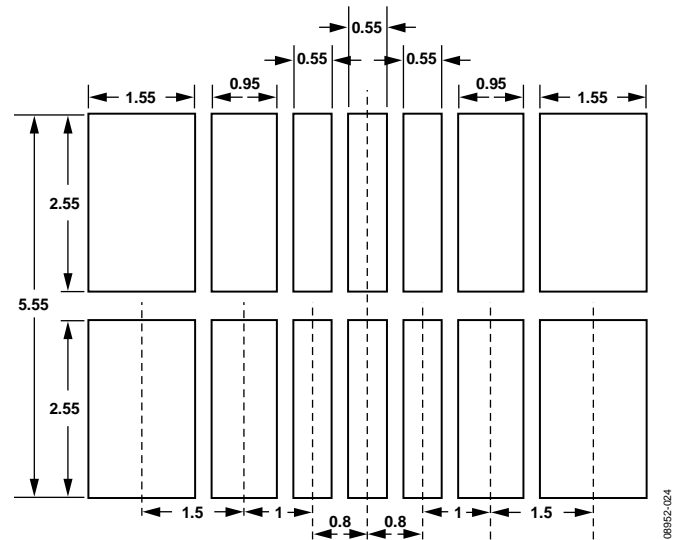

Figure 28. LCC_V Solder Pad Layout, Dimensions Shown In Millimeters, Not To Scale



Figure 29. Recommended Soldering Profile

Table 17. Solder Profile Conditions

Profile Feature	Conditions	
	Sn63/Pb37	Pb Free
Average Ramp Rate (T_L to T_P)	3°C/sec maximum	
Preheat		
Minimum Temperature (T_{SMIN})	100°C	150°C
Maximum Temperature (T_{SMAX})	150°C	200°C
Time (T_{SMIN} to T_{SMAX}) (t_s)	60 sec to 120 sec	60 sec to 120 sec
T_{SMAX} to T_L		
Ramp-Up Rate	3°C/sec maximum	
Time Maintained above Liquidous		
Liquidous Temperature (T_L)	183°C	217°C
Time (t_L)	60 sec to 150 sec	60 sec to 150 sec
Peak Temperature (T_P)	240°C + 0°C/-5°C	260°C + 0°C/-5°C
Time Within 5°C of Actual Peak Temperature (t_p)	10 sec to 30 sec	20 sec to 40 sec
Ramp-Down Rate	6°C/sec maximum	
Time 25°C to Peak Temperature	6 minutes maximum	8 minutes maximum

PACKAGE MARKING CODES

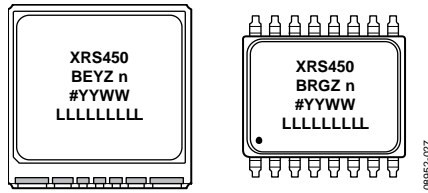

Figure 30. LCC_V and SOIC_CAV Package Marking Codes

Table 18. Package Code Designations

Marking	Significance
XRS	Angular rate sensor
450	Series number
B	Temperature Grade (−40°C to +105°C)
RG	Package designator (SOIC_CAV package)
EY	Package designator (LCC_V package)
Z	RoHS compliant
n	Revision number
#	Pb-Free designation
YYWW	Assembly date code
LLLLLLLL	Assembly lot code (up to 9 characters)

OUTLINE DIMENSIONS



Figure 31. 16-Lead Small Outline, Plastic Cavity Package [SOIC_CAV] (RG-16-1)
Dimensions shown in millimeters

01-30-2013-B



Figure 32. 14-Terminal Ceramic Leadless Chip Carrier [LCC_V] (EY-14-1)
Dimensions shown in millimeters

04-08-2010-A

ORDERING GUIDE

Model¹	Temperature Range	Package Description	Package Option
ADXRS450BEYZ	-40°C to +105°C	14-Terminal Ceramic Leadless Chip Carrier, Vertical Form [LCC_V]	EY-14-1
ADXRS450BEYZ-RL	-40°C to +105°C	14-Terminal Ceramic Leadless Chip Carrier, Vertical Form [LCC_V]	EY-14-1
ADXRS450BRGZ	-40°C to +105°C	16-Lead Small Outline, Plastic Cavity Package [SOIC_CAV]	RG-16-1
ADXRS450BRGZ-RL	-40°C to +105°C	16-Lead Small Outline, Plastic Cavity Package [SOIC_CAV]	RG-16-1
EVAL-ADXRS450Z		Evaluation Board SOIC_CAV	
EVAL-ADXRS450Z-V		Evaluation Board LCC_V	
EVAL-ADXRS450Z-M		Analog Devices Inertial Sensor Evaluation System (Includes ADXRS450 Satellite)	
EVAL-ADXRS450Z-S		ADXRS450 Satellite, Standalone, to be used with Inertial Sensor Evaluation System	

¹ Z = RoHS Compliant Part.