

High Power Positive Hot-Swap Controller with Power Monitor via PMBus

FEATURES

- ▶ Wide operating voltage range: 8.5 V to 80 V
- ▶ Monitors currents, voltages, and power with ADC
- ▶ Adjustable, 5% accurate current limit: 6 mV to 20 mV
- ▶ Current foldback limits MOSFET power dissipation for overstress protection
- ▶ Monitors V_{GS} and V_{DS} for MOSFET health
- ▶ Peak detect registers for current, voltage, and power
- ▶ Reports input or output power
- ▶ Remote temperature sensing with programmable warning and shutdown thresholds
- ▶ $\pm 1\%$ accurate, 12-bit ADC for I_{OUT} , V_{IN} , and V_{OUT}
- ▶ Available in 39-lead, 7 mm x 7 mm, QFN package

APPLICATIONS

- ▶ High availability server backplane systems
- ▶ 12 V/24 V/48 V/54 V Distributed power systems
- ▶ Industrial

TYPICAL APPLICATION

GENERAL DESCRIPTION

The LTC4286 is an integrated solution for hot-swap applications allowing a board to be safely inserted and removed from a live backplane. The circuit breaker timer protects against metal-oxide semiconductor field-effect transistor (MOSFET) overheating, enabling reliable protection against overstress.

The SMBus 3.1 interface, PMBus command structure, and on-board analog-to-digital converter (ADC) with selectable averaging and speed allow monitoring of board current, voltage, power, temperature, and fault status.

The LTC4286 has additional features to respond to input undervoltage (UV) and overvoltage (OV): interrupts the host when a fault occurs, notifies when output power is good, detects insertion of a board, and auto-reboot after a programmable delay following a host commanded turn off.

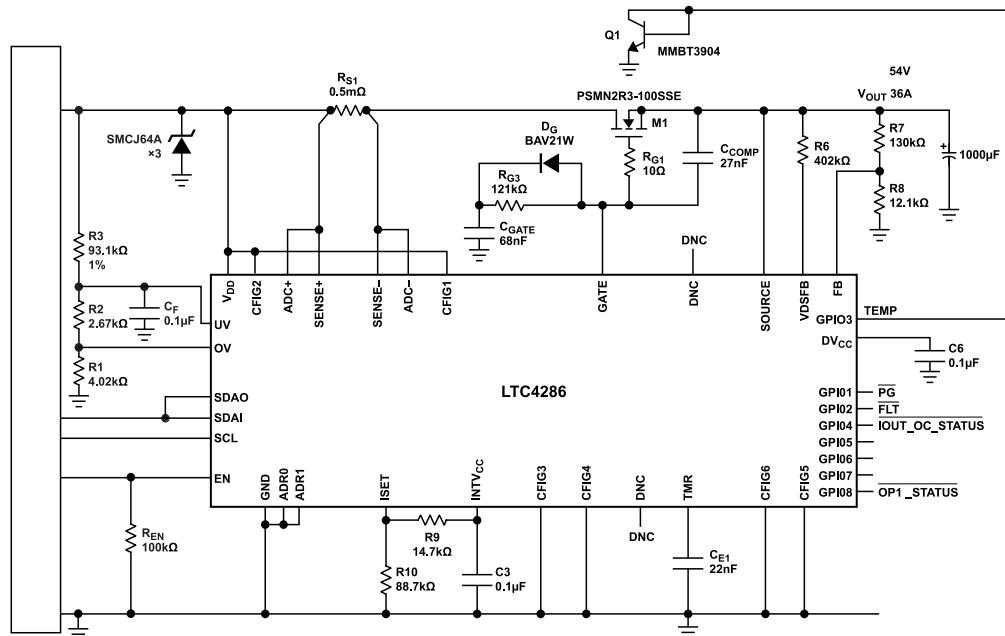

Figure 1. 54 V, 1100 W Hot-Swap Controller

TABLE OF CONTENTS

Features.....	1	MOSFET SOA-Timer Capacitor.....	16
Applications.....	1	Data Converters.....	18
General Description.....	1	SMBus Serial Interface.....	20
Typical Application.....	1	PMBus Command Summary.....	22
Electrical Characteristics.....	3	ADC-Related Commands and Aliases.....	26
Absolute Maximum Ratings.....	7	Status Register Summary.....	29
ESD Caution.....	7	Latched Status and Mask Commands.....	30
Pin Configuration and Function Descriptions.....	8	GPIO Output Selection.....	40
Typical Performance Characteristics.....	11	Typical Application.....	42
Theory of Operation.....	14	Related Parts.....	42
Applications Information.....	15	Outline Dimensions.....	43
Overview.....	16	Ordering Guide.....	44
Turn-On Sequence.....	16	Evaluation Boards.....	44
Turn-Off Sequence.....	16		

REVISION HISTORY**1/2023—Revision 0: Initial Version**

ELECTRICAL CHARACTERISTICS

Specifications apply over the full operating temperature range, unless otherwise noted. All currents into pins are positive and all voltages are referenced to GND, unless otherwise specified.

Table 1. Electrical Characteristics

Parameter	Test Conditions/Comments	Min	Typ	Max	Unit
POWER SUPPLY					
Input Supply Range, V_{DD}		8.5		80	V
Input Supply Current, I_{DD}	No external resistor V_{IN} to $INTV_{CC}$, no load on DV_{CC}		12	18	mA
	5 k Ω pull-up on $INTV_{CC}$ from V_{DD} , 48 V, $T_A = 25^\circ\text{C}$, $V_{DD} = 48\text{ V}$		1.8		mA
Input Supply Undervoltage Lockout, $V_{DD(UVLO)}$	V_{DD} rising	5.75	6	6.35	V
	V_{DD} falling	5.25	5.5	5.85	V
Input Supply Undervoltage Lockout Hysteresis, $\Delta V_{DD(HYST)}$	$T_A = 25^\circ\text{C}$, $V_{DD} = 48\text{ V}$		0.5		V
$INTV_{CC}$ Output Voltage, $INTV_{CC}$	$V_{DD} = 8.5\text{ V}$ and 80 V , $I_{LOAD} = 0\text{ mA}$ and -4 mA	4.5	5	5.5	V
$INTV_{CC}$ Undervoltage Lockout, $INTV_{CC(UVLO)}$	$INTV_{CC}$ falling	3.4	3.89	4.45	V
	$INTV_{CC}$ rising	3.6	4	4.5	V
$INTV_{CC}$ Undervoltage Lockout Hysteresis, $\Delta INTV_{CC(UVLO)}$	$T_A = 25^\circ\text{C}$, $V_{DD} = 48\text{ V}$		115		mV
DV_{CC} Output Voltage, DV_{CC}	$V_{DD} = 8.5\text{ V}$, 80 V , $I_{LOAD} = 0\text{ mA}$	4.5	5	5.5	V
DV_{CC} Undervoltage Lockout, $DV_{CC(UVLO)}$	DV_{CC} falling	1.7	2	2.5	V
	DV_{CC} rising	1.9	2.2	2.5	V
DV_{CC} Undervoltage Lockout Hysteresis,	$T_A = 25^\circ\text{C}$, $V_{DD} = 48\text{ V}$		150		mV
GATE DRIVE					
External N-Channel Gate Drive at GATE ($V_{GATE} - V_{SOURCE}$), ΔV_{GATE} ¹	$V_{DD} = 8.5\text{ V}$ to 80 V , $I_{GATE} = 0\text{ }\mu\text{A}$ and $-10\text{ }\mu\text{A}$	10	12	14	V
GATE Pull-Up Current, $I_{GATE(UP)}$	Gate drive on, $V_{GATE} = V_{SOURCE} = 0\text{ V}$	-35	-53	-70	μA
GATE Pull-Down Current, $I_{GATE(DN)}$	Gate drive on, $V_{GATE} = 58\text{ V}$, $V_{SOURCE} = 48\text{ V}$	6	12	15	mA
GATE Fast Pull-Down Current, $I_{GATE(FST)}$	Fast turn off, $V_{GATE} = 58\text{ V}$, $V_{OUT} = 48\text{ V}$, $T_A = 25^\circ\text{C}$, $V_{DD} = 48\text{ V}$		1		A
Gate-Source Voltage for FET-Bad and Power-Failed Faults, $V_{TH(GS)}$		6	8	10	V
Δ SENSE High to GATE Low Propagation Delay, $t_{PHL(SENSE)}$	$I_{LIM} = 0000$, $\Delta V_{SNS} = 0$ to 100 mV step, $\Delta V_{GATE} = 6\text{ V}$, $C_{GATE} = 10\text{ nF}$,		0.5	1	μs
GATE Off Propagation Delay: OV, $t_{PHL(GATE)OV}$	OV = high, $\Delta V_{GATE} = 6\text{ V}$ gate open		1	2	μs
GATE ON Propagation Delay:OV, $t_{PHL(GATE)OV}$	OV = low	0	5	10	μs
GATE Off Propagation Delay: UV, $t_{PHL(GATE)UV}$	UV = low, $\Delta V_{GATE} = 6\text{ V}$ gate open	0.3	2	3	μs
GATE Off Propagation Delay: EN, $t_{PHL(GATE)EN}$	EN = low, $\Delta V_{GATE} = 6\text{ V}$ gate open	15	40	70	μs
V_{DD} to Source Threshold Voltage for Power Bad Faults, $V_{DS(POWER_BAD)}$	V_{DD} to source falling	1.6	2.0	2.4	V
FET Bad Fault Threshold (V_{DD} -SOURCE) to start FETBAD timer, $V_{TH,FET-BAD}$	V_{DD} to source rising	140	200	260	mV
TIMING					
Power-Good Delay, $t_{DL(PG)}$		172	181	190	ms
Debounce Delay, Auto-Retry Delay Following Undervoltage Fault, $t_{DL(DB)}$		86.1	90.6	95.2	ms
FET BAD Delay, $t_{DL(FETBAD)}$		0.138	0.145	0.152	Sec
Auto-Retry Delay Following Overcurrent Fault, input/output Fault, or FET Bad Fault, $t_{DL(RTRY)}$		8.82	9.28	9.74	Sec
Auto-Retry Counter Reset Delay, $t_{DL(RTCRST)}$	$VIN_UV_FAULT_RETRY$, $VIN_OV_FAULT_RETRY$, OC_FAULT_RETRY , OT_FAULT_RETRY , $OP_FAULT_RETRY = 001$ to 110	88.2	92.8	97.4	Sec
OP1 Fault Unit Delay, $t_{DL(OP1-UNIT)}$	Delay = $OP_TIMER(\text{Value}) \times \text{Unit Delay}$	1.08	1.13	1.19	ms

ELECTRICAL CHARACTERISTICS

Table 1. Electrical Characteristics (Continued)

Parameter	Test Conditions/Comments	Min	Typ	Max	Unit
CURRENT LIMIT					
Current-Limit Sense Voltage Threshold, ($V_{SENSE+} - V_{SENSE-}$), ΔV_{SNS}	ILIM = 0001	5.67	6	6.33	mV
	ILIM = 1111	18.55	20	21.45	mV
Current-Limit Sense Voltage Linearity, ΔV_{SNS}			0	± 100	μV
Foldback Factor, ΔV_{SNS}	30%	15	30	45	%
Fast Pull-Down Threshold Multiplier, $V_{(TH)FPD}$	$T_A = 25^\circ C$, $V_{DD} = 48 V$		3		
SENSE+ Input Current, $I_{SENSE+(IN)}$	SENSE- = SENSE+ = V_{DD}	0	120	250	μA
SENSE- Input Current, $I_{SENSE-(IN)}$	$V_{DD} - Source = 5 V$	4	5	6	μA
OVERCURRENT TIMER					
TMR Fault Threshold, $V_{TMR(H)}$	V_{TMR} rising	2.5	2.56	2.62	V
TMR Low Threshold, $V_{TMR(L)}$	V_{TMR} falling	0.18	0.2	0.22	V
TMR Pull-Up Current, $I_{TMR(UP)}$	$V_{TMR} = 0 V$	-15	-20	-25	μA
TMR Pull-Down Current, $I_{TMR(DN)}$	$V_{TMR} = 2.56 V$	3	5	7	μA
INPUT PINS					
UV/OV/FB Threshold Voltage, $V_{(TH)UV/OV/FB}$	V_{PIN} rising	2.51	2.56	2.61	V
OV Threshold Voltage, $V_{(TH)OV}$	V_{OV} falling	2.3	2.5	2.6	V
OV Hysteresis, $\Delta V_{(HYST)OV}$	$T_A = 25^\circ C$, $V_{DD} = 48 V$		55		mV
UV Threshold Voltage, $V_{(TH)UVF}$	V_{UV} falling	2.15	2.2	2.25	V
FB Threshold Voltage, $V_{(TH)FB}$	V_{FB} falling	2.3	2.5	2.61	V
FB Hysteresis, $\Delta V_{(HYST)FB}$	$T_A = 25^\circ C$, $V_{DD} = 48 V$		79		mV
UV Hysteresis, $\Delta V_{(HYST)UV}$	$T_A = 25^\circ C$, $V_{DD} = 48 V$		360		mV
UV Retry Threshold Voltage, $V_{(TH)UVR}$	V_{UVR} rising	1	1.1	1.2	V
UV Retry Threshold Voltage, $V_{(TH)UVR}$	V_{UVR} falling	0.95	1.0	1.05	V
UV Retry Threshold Hysteresis, $\Delta V_{(HYST)UVR}$	$T_A = 25^\circ C$, $V_{DD} = 48 V$		100		mV
ADR0, ADR1, Input High Threshold, $V_{ADR(H)}$		INTV _{CC} - 0.8	INTV _{CC} - 0.5	INTV _{CC} - 0.2	V
ADR0, ADR1, Input Low Threshold, $V_{ADR(L)}$		0.2	0.5	0.8	V
ADR0, ADR1, Input Current, $I_{ADR(IN)}$	$V_{PIN} = 1 V$, $V_{PIN} = INTV_{CC} - 0.85 V$			± 10	μA
EN Threshold Voltage, $V_{EN(TH)}$	V_{EN} rising	1.25	1.28	1.31	V
	V_{EN} falling	1.225	1.26	1.295	V
EN Hysteresis, $\Delta V_{EN(HYST)}$	$T_A = 25^\circ C$, $V_{DD} = 48 V$		20		mV
GPIO1-8 Pin Threshold Voltage, $V_{(TH)GPIO}$	V_{GPIO} rising	1.25	1.28	1.31	V
	V_{GPIO} falling	1.225	1.26	1.295	V
GPIO1-8 Pin Hysteresis, $\Delta V_{(HYST)GPIO}$	$T_A = 25^\circ C$, $V_{DD} = 48 V$		20		mV
VDSFB Internal Resistor, R_{VDSFB}	Gate on	75	120	150	k Ω
VDSFB Leakage Current, $I_{LEAK, VDSFB}$	$V_{VDSFB} = 0 V$, $V_{DD} = 80 V$, gate off		0	± 1	μA
SOURCE Input Current, I_{SOURCE}	$V_{SOURCE} = 48 V$, gate on			300	μA
	$V_{SOURCE} = 0 V$, gate off			-200	μA
	$V_{SOURCE} = 2 V$, gate off	0		500	μA
OV, UV, EN, FB Input Current, I_{INPUT}	OV, UV, EN, FB = 2.5 V		0	± 1	μA
OUTPUT PINS					
GPIO1-8 Output Low Voltage, V_{OL}	$I_{GPIO1 \text{ to } GPIO8} = 3 mA$		0.2	0.5	V
GPIO1-8 Leakage Current, $I_{LEAK, GPIO}$	GPIO4, GPIO8 = 6 V, GPIO1, GPIO2, GPIO6 = 80 V, GPIO3, GPIO5, GPIO7 = INTV _{CC}		0	± 1	μA
ADC					
Resolution (No Missing Codes) ²	All channels	12			Bits
Full-Scale Voltage, V_{FS}	$T_A = 25^\circ C$, $V_{DD} = 48 V$ (ADC+ - ADC-)		32		mV
	V_{DS}		320		mV

ELECTRICAL CHARACTERISTICS

Table 1. Electrical Characteristics (Continued)

Parameter	Test Conditions/Comments	Min	Typ	Max	Unit
LSB Step Voltage, LSB	V _{DD} /SOURCE, 25.6 V range		25		V
	V _{DD} /SOURCE, 100 V range		102.4		V
	(ADC+ - ADC-), T _A = 25°C, V _{DD} = 48 V		7.8		μV
	V _{DS}		78		μV
	V _{DD} /SOURCE, 25 V range		6.25		mV
Offset Error, V _{OS}	V _{DD} /SOURCE, 100 V range		25		mV
	ADC+ - ADC			±20	LSB
	V _{DD} /SOURCE, T _A = 25°C, V _{DD} = 48 V			±10	LSB
Integral Nonlinearity, INL	V _{DS}	-10		50	LSB
	(ADC+ - ADC-), V _{DD} /SOURCE, V _{DS} , T _A = 25°C, V _{DD} = 48 V		±1		LSB
Full-Scale Error, FSE	(ADC+ - ADC-), V _{DD} /SOURCE			±1	%
	V _{DS}	-3		+1	%
Refresh Rate in Continuous Mode, Internal Oscillator, f _{CONV}	(ADC+ - ADC-), V _{DD} /SOURCE, power	3.36	3.53	3.71	kHz
	V _{DS}	1.68	1.77	1.86	kHz
Individual Channel Conversion Time, Internal Oscillator, t _{CONV}	(ADC+ - ADC-), V _{DS}	269	283	310	μs
	V _{DD} /SOURCE	269	283	310	μs
ADC+ Input Current, I _{ADC+}	V _(ADC+) = V _{DD} = 48 V, V _(ADC-) = V _{DD} - 21.3 mV		73	132	μA
ADC- Input Current, I _{ADC-}	V _(ADC+) = V _{DD} = 48 V, V _(ADC-) = V _{DD} - 21.3 mV		0	±1	μA
TEMPERATURE MEASUREMENT					
Resolution (No Missing Codes) ²			10		Bits
Refresh Rate in Continuous Mode, f _{TCONV}			3.45		Hz
Full-Scale Temperature Range, R _{TFS}	T _A = 25°C, V _{DD} = 48 V	-273		751	°C
Temperature Measurement Range, R _{TOP}	T _A = 25°C, V _{DD} = 48 V	-55		175	°C
Remote Temperature Error, η = 1.004, T _{RMT}	-40°C to 125°C ³ , T _A = 25°C, V _{DD} = 48 V		±1	±10	°C
Temperature LSB Step, LSB _{TEMP}	T _A = 25°C, V _{DD} = 48 V		1		°C
TEMP Current, I _{TEMP}	Low level, T _A = 25°C, V _{DD} = 48 V		10		μA
	Midlevel, T _A = 25°C, V _{DD} = 48 V		80		μA
	High level, T _A = 25°C, V _{DD} = 48 V		150		μA
SMBus INTERFACE ⁴					
SDAO Output Low Voltage, V _{SDAO(OL)}	ISDAO = 20 mA			0.5	V
SDAO Input Current, I _{SDAO}	SDAO = 5 V		0	±1	μA
SDAI, SCL Input Threshold, V _{SDAI,SCL(TH)}		0.9	1.1	1.35	V
SDAI, SCL Input Current, I _{SDAI,SCL}	SDAI, SCL = 5 V		0	±1	μA
SMBus INTERFACE TIMING ^{2,4}					
SCL Clock Frequency, f _{SCL}	T _A = 25°C, V _{DD} = 48 V	10		1000	kHz
SCL Low Period, t _{LOW}	T _A = 25°C, V _{DD} = 48 V	0.40			μs
SCL High Period, t _{HIGH}	T _A = 25°C, V _{DD} = 48 V	0.20			μs
Data Setup Time, t _{SU,DAT}	SDAI setup from SCL ↑ for data, T _A = 25°C, V _{DD} = 48 V	20			ns
Data Hold Time, t _{HD,DAT}	SDAI hold from SCL ↓ for data, T _A = 25°C, V _{DD} = 48 V	0			ns
Hold Time Start Bit, t _{HD,STA}	SCL high after SDAI ↓, T _A = 25°C, V _{DD} = 48 V	160			ns
Setup Time for Repeated Start, t _{SU,STA}	SCL high setup to SDAI ↓, T _A = 25°C, V _{DD} = 48 V	160			ns
Setup Time for Stop bit, t _{SU,STO}	SCL high setup to SDAI ↑, T _A = 25°C, V _{DD} = 48 V	160			ns
SDAO delay, t _{DEL,SDAO}	SDAO ↓ delay from SCL ↓, SEL_1M = 0, T _A = 25°C, V _{DD} = 48 V	100	175	405	ns
	SDAO ↓ delay from SCL ↓, SEL_1M = 1, T _A = 25°C, V _{DD} = 48 V	75	125	220	ns
SCL or SDAI Pulse Spike Rejection, t _{PW} ²	T _A = 25°C, V _{DD} = 48 V	55	75	110	ns
PMBus Stuck Bus Timeout, T _{D(STUCK)}	T _A = 25°C, V _{DD} = 48 V	25	30	35	ms

ELECTRICAL CHARACTERISTICS

Table 1. Electrical Characteristics (Continued)

Parameter	Test Conditions/Comments	Min	Typ	Max	Unit
SCL, SDA Input Capacitance, C_X	SDAI tied to SDAO, $T_A = 25^\circ\text{C}$, $V_{DD} = 4.8\text{ V}$		5	10	pF

¹ An internal clamp limits the GATE pin to a minimum of 10 V above SOURCE. Driving this pin to voltages beyond the clamp can damage the device.

² Guaranteed by design and characterization.

³ Remote diode temperature, not LTC4286 temperature. Guaranteed by design and test correlation.

⁴ The LTC4286 is fully compliant with SMBus 3.1 and operation up to 1 Mbps. In general, the chip can be used in I²C bus systems using standard-mode, fast-mode, or fast-mode plus as long as PMBus command protocols are followed. A V_{IH}/V_{IL} incompatibility between SMBus 3.1 and I²C can lead to a DC level violation for I²C buses running at 3.5 V or higher.

ABSOLUTE MAXIMUM RATINGS

All currents into pins are positive and all voltages are referenced to GND, unless otherwise specified.

Table 2. Absolute Maximum Ratings

Parameter	Rating
Supply Voltages	
V_{DD}	-0.3 V to +100 V
INTV _{CC} , DV _{CC}	-0.3 V to +5.5 V
Input Voltages	
SDAI, SCL	-0.3 V to +6 V
CFIG4	-0.3 V to +1 V
OV, UV, FB, EN	-0.3 V to +100 V
VDSFB	-0.3 V to $V_{DD} + 0.3$ V
TMR, ADR0, ADR1, CFG3	-0.3 V to INTV _{CC} + 0.3 V
ADC+, SENSE+	$V_{DD} - 4.5$ V to $V_{DD} + 0.3$ V
ADC-, SENSE-	$V_{DD} - 4.5$ V to $V_{DD} + 0.3$ V
CFG1, CFG2	$V_{DD} - 4.5$ V to $V_{DD} + 0.3$ V
SOURCE	-0.3 V to +100 V
GATE - SOURCE ¹	-0.3 V to +10 V
Output Voltages	
ISET, CFG5, CFG6	-0.3 V to DV _{CC} + 0.3 V
GPIO1, GPIO2, GPIO6	-0.3 V to 100 V
GPIO3, GPIO5, GPIO7	-0.3 V to INTV _{CC} + 0.3 V
GATE	-0.3 V to +100 V
SDAO, GPIO4, GPIO8	-0.3 V to +6 V
Output Currents	
INTV _{CC} , DV _{CC}	-5 mA
Temperature	
Operating Range	-40°C to +125°C
Storage Range	-65°C to +150°C

¹ An internal clamp limits the GATE pin to a minimum of 10 V above SOURCE. Driving this pin to voltages beyond the clamp may damage the device.

Stresses at or above those listed under Absolute Maximum Ratings may cause permanent damage to the product. This is a stress rating only; functional operation of the product at these or any other conditions above those indicated in the operational section of this specification is not implied. Operation beyond the maximum operating conditions for extended periods may affect product reliability.

ESD CAUTION



ESD (electrostatic discharge) sensitive device. Charged devices and circuit boards can discharge without detection. Although this product features patented or proprietary protection circuitry, damage may occur on devices subjected to high energy ESD. Therefore, proper ESD precautions should be taken to avoid performance degradation or loss of functionality.

PIN CONFIGURATION AND FUNCTION DESCRIPTIONS

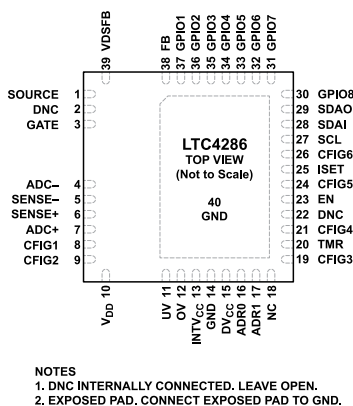

Figure 2. Pin Configuration

Table 3. Pin Function Descriptions

Pin No.	Mnemonic	Description
1	SOURCE	N-channel MOSFET Source and ADC Input. Connect this pin to the source of the external N-channel MOSFET. This pin provides a return for the GATE pull-down circuit, is used as an input to the 200 mV and 2 V V_{DS} comparators that are used for FET-BAD faults and Power_Good, respectively. The SOURCE pin also serves as an ADC input to monitor the output voltage.
2, 22	DNC	Do not connect. Leave open.
3	GATE	Gate Drive Output for External N-channel MOSFET. Internal 50 μ A current source charges the gate of the MOSFET. No compensation capacitors are required on the GATE pin, but an RC network from this pin to ground can be used to set the turn-on output voltage slew rate. During turn-off, there is a 10 mA pull-down current to SOURCE and a 1 mA pull-down current to GND. During a short-circuit or undervoltage lockout (V_{DD} , $INTV_{CC}$), a 1 A pull-down between GATE and SOURCE is activated.
4	ADC-	Negative Kelvin ADC Current Sense Input. Connect this pin to the output side of the current sense resistor or a resistive averaging network when using multiple sense resistors.
5	SENSE-	Negative Kelvin Current Sense Input. Connect this pin to the MOSFET side of the current sense resistor. The current-limit circuit controls the GATE pin to limit the sense voltage between the SENSE+ and SENSE- pins to the limit value selected by the ISET pin.
6	SENSE+	Positive Kelvin Current Sense Input. Connect this pin to the V_{DD} side of the current sense resistor.
7	ADC+	Positive Kelvin ADC Current Sense Input. Connect this pin to the input side of the current sense resistor or a resistive averaging network when using multiple sense resistors. Must be connected to the same trace as V_{DD} or a resistive averaging network, which adds up to 1 Ω to V_{DD} .
8	CFG1	Configuration Input. Tie to V_{DD} .
9	CFG2	Configuration Input. Tie to V_{DD} .
10	V_{DD}	Supply Voltage Input. This pin has an undervoltage lockout threshold of 6 V. V_{DD} is an input for the FET-BAD comparator with a 200 mV threshold. It is also an input for the power bad comparator with a 2 V threshold. The ADC can be configured to measure the voltage at this pin.
11	UV	Undervoltage Comparator Input. Connect this pin to an external resistive-divider from V_{DD} to GND. If the UV pin falls below 2.2 V, an undervoltage occurs, and the MOSFET turns off. If the UV pin rises above 2.56 V, the MOSFET turns on after a debounce delay of 90.6 ms. Pulling this pin below 1 V adds one retry to the retry counter for an OC, FET_BAD, OT, or OP fault, which is linked to the FAULT# GPIO output in MFR_FLT_CONFIG if that fault has zero remaining retries. If overcurrent auto-retry is required, then tie this pin to the GPIO2 pin, which is configured as a FAULT# output reporting OC and FET_BAD faults by default. Tie to $INTV_{CC}$ if unused or connect to a GPIO pin with a 4.7 k Ω pull-up to $INTV_{CC}$ if only the auto-retry function is used.
12	OV	Overvoltage Comparator Input. Connect OV to an external resistive voltage-divider from V_{DD} to GND. An overvoltage fault occurs if this pin rises above the 2.56 V threshold. When the OV pin voltage falls back below the 2.5 V falling threshold, the GATE pin turns on again immediately. Tie to GND if unused.
13	$INTV_{CC}$	Internal Supply Decoupling Output. Connect a capacitor no smaller than 0.1 μ F from this pin to the ground. Up to 5 mA can be drawn from this pin to power 5 V application circuitry. This pin is current-limited and drops to GND to reduce heating in an overcurrent condition. Overloading this pin can disrupt internal operation. To reduce heating,

PIN CONFIGURATION AND FUNCTION DESCRIPTIONS

Table 3. Pin Function Descriptions (Continued)

Pin No.	Mnemonic	Description
14	GND	this pin can act as a shunt regulator by connecting a resistor to V_{DD} or another supply such that 10 mA flows to $INTV_{CC}$. Device Ground.
15	DV _{CC}	5 V Internal Logic Supply Output. This is an output of the internal linear regulator with an UVLO threshold of DV _{CC} (UVLO). The voltage at this pin powers up the logic control circuitry and SMBus interface. Bypass this pin with a 0.1 μ F capacitor.
16, 17	ADR0, ADR1	Serial Bus Address Inputs. Tying these pins to ground (L), open (NC) or $INTV_{CC}$ (H) configures one of nine possible addresses. See Table 9.
18	NC	Not internally connected.
19	CFIG3	Configuration Input. Tie to GND.
20	TMR	Current-Limit Timer. Connect a capacitor between this pin and ground to set a 128 ms/ μ F duration for current limit before the MOSFET is turned off. If configured to auto-retry or if the UV pin is toggled low, the MOSFET turns on again following a cool-down time of 9.28 s.
21	CFIG4	Configuration Input. Tie to GND.
23	EN	Active High Enable Input. EN is typically used to indicate that a board is present. The external MOSFET can only be turned on when EN is active and the ON bit in the OPERATION register is set. See Table 4 for the ON bit defaults at power-up. Any transition on this pin sets the EN_CHANGED bit in MFR_SPECIFIC_STATUS.
24	CFIG5	Configuration Input. Tie to GND.
25	ISET	Current-Limit Adjustment Input. The ISET voltage is compared with seven threshold voltages generated by a resistive voltage-divider from $INTV_{CC}$. The result sets the current-limit voltage to be one of eight discrete values from 6 mV to 20 mV in 2 mV increments. When ISET is connected to ground, the current-limit threshold is set to 6 mV. When ISET is connected to $INTV_{CC}$, current-limit threshold is set to 20 mV (see Table 5).
26	CFIG6	Initial ON Configuration Input. Tie to GND to turn on automatically, tie to 1.6 V with a resistive divider to remain off awaiting further instructions. For more details, see Table 4.
27	SCL	SMBus-compatible Clock Input, high impedance.
28	SDAI	Serial Bus Data Input. A high impedance input for shifting in address, command, or data bits. Normally tied to SDAO to form the SDA line.
29	SDAO	Serial Bus Data Output. Open-drain output for sending data back to the controller or acknowledging a write operation. Normally tied to SDAI to form the SDA line. An external pull-up resistor or current source is required.
30	GPIO8	OP1_STATUS# Indicator Output. This pin is pulled low when the ADCs measure a power level above the OP1 threshold. Tie to GND if unused.
31	GPIO7	Comparator Output. This pin is the output of the comparator on the GPIO6 pin. Tie to GND if unused.
32	GPIO6	Comparator Input. This pin has a 1.28 V threshold. The output of the comparator is available on GPIO7. Tie to GND if unused.
33	GPIO5	This pin has a reserved function by default. Leave it open unless changing its configuration register.
34	GPIO4	IOUT_OC_STATUS# Indicator Output. When the LTC4286 is in current limit, this open-drain output is pulled low to indicate an overcurrent condition. Tie to GND if unused.
35	GPIO3	Temperature Sensor Input. Connect to an MMBT3904 transistor for use as a remote temperature sensor. Tie to GND if unused.
36	GPIO2	FAULT# Output. This pin pulls low when an overcurrent or FET-BAD fault occurs. This pin can be tied to the UV pin to clear faults and auto-retry after a fault occurs. Tie to GND if unused.
37	GPIO1	Power-Good# Indicator Output. This open drain pull-down pulls low when power is good, as determined by the FB pin and GATE pin voltages. Tie to GND if unused.
30 to 37	GPIO1 to GPIO8	General-purpose I/O with open-drain output drivers. Several digital I/O functions are available for these pins. Those functions can be assigned by configuration to any of the eight pins. With few exceptions, the pins behave identically. GPIO1, GPIO2, and GPIO6 can be externally pulled as high as V_{DD} . The others must not be pulled any higher than DV _{CC} . The external temperature sensor function is available on GPIO3 only. Individual GPIO pin descriptions further refer to the hardware default configuration. By default, all alerts are disabled, and no GPIO pins are assigned to ALERT#, which can be changed after power-up by writing configuration registers.
38	FB	Power-Good Input. Connect this pin to an external resistive divider from SOURCE to GND. When the voltage at this pin drops below 2.56 V, power is not considered good. The power bad condition can result in a GPIO Power Good# pin pulling low or going high impedance depending on the GPIO pin configuration. Also a power bad fault is logged in this condition if a GATE pin is high. Tie to $INTV_{CC}$ if unused.

PIN CONFIGURATION AND FUNCTION DESCRIPTIONS**Table 3. Pin Function Descriptions (Continued)**

Pin No.	Mnemonic	Description
39	VDSFB	VDS Foldback Sense Input. This pin is used to monitor the drain to source voltage of the external MOSFETs, which is used to set the foldback current limit. VDSFB is tied to SOURCE for 12 V applications, and an additional 10 k Ω /V is added for higher operating voltages, to set the proper gain of the foldback circuit.
40	EPAD (GND)	Exposed Pad. Connect exposed pad to GND.

TYPICAL PERFORMANCE CHARACTERISTICS

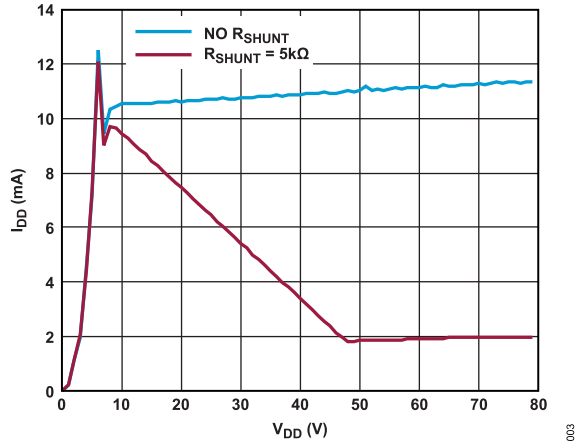

Figure 3. I_{DD} vs. V_{DD}

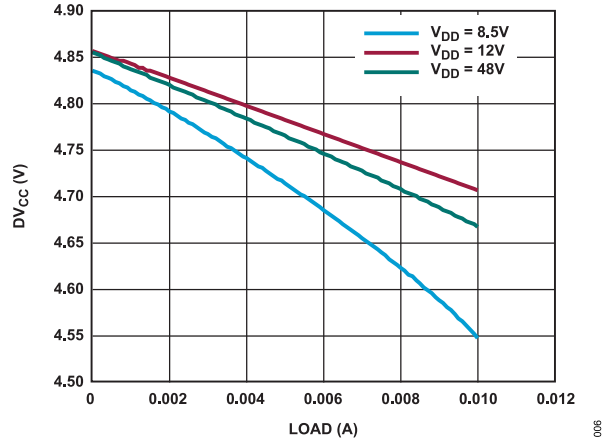

Figure 6. DV_{CC} vs. Load at $V_{DD} = 8.5V, 12V, \text{ and } 48V$

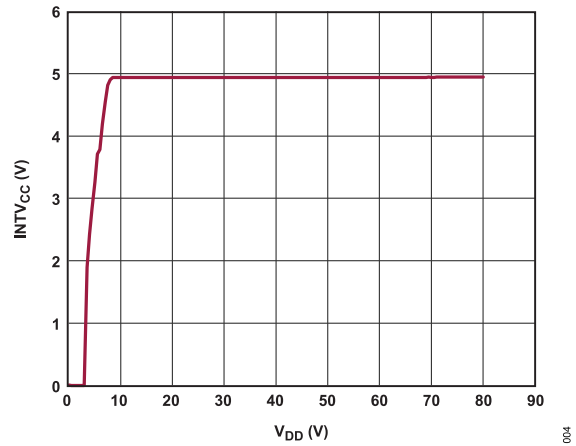

Figure 4. $INTV_{CC}$ vs. V_{DD}

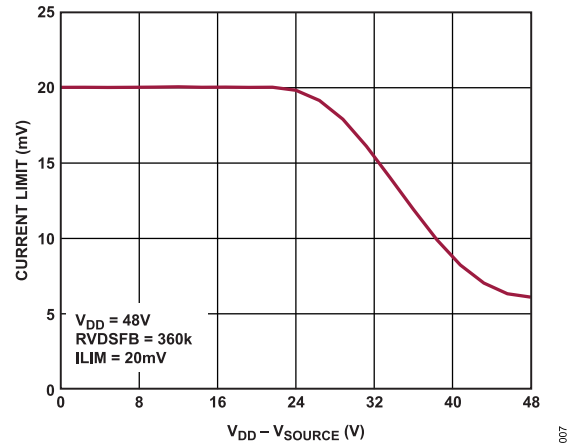

Figure 7. Current-Limit Foldback Profiles

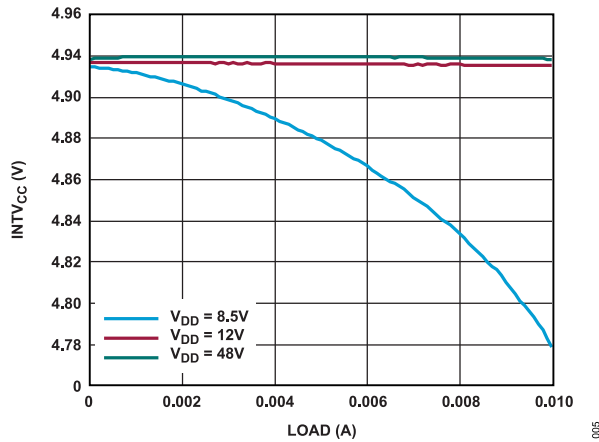

Figure 5. $INTV_{CC}$ vs. Load at $V_{DD} = 8.5V, 12V, \text{ and } 48V$

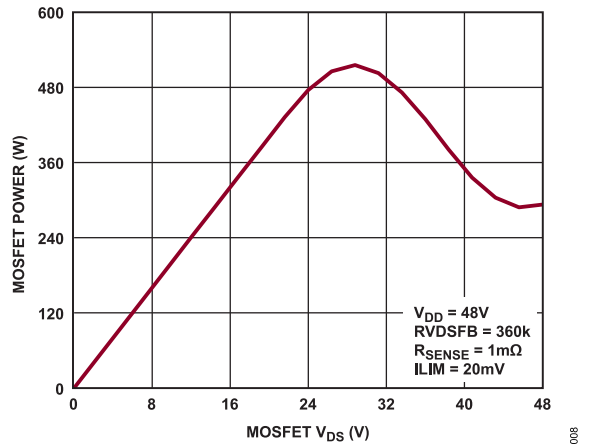

Figure 8. MOSFET Power vs. V_{DS}

TYPICAL PERFORMANCE CHARACTERISTICS

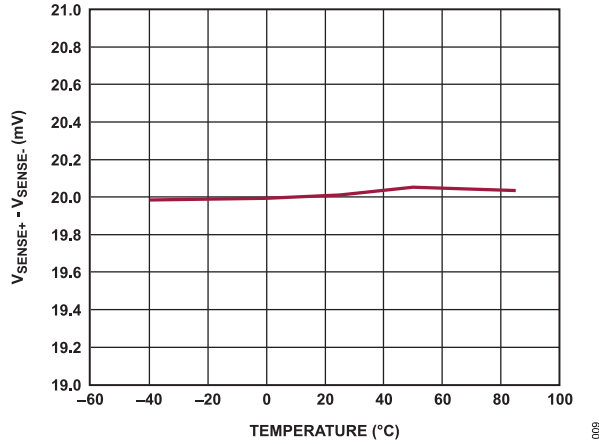

Figure 9. Current-Limit Threshold vs. Temperature

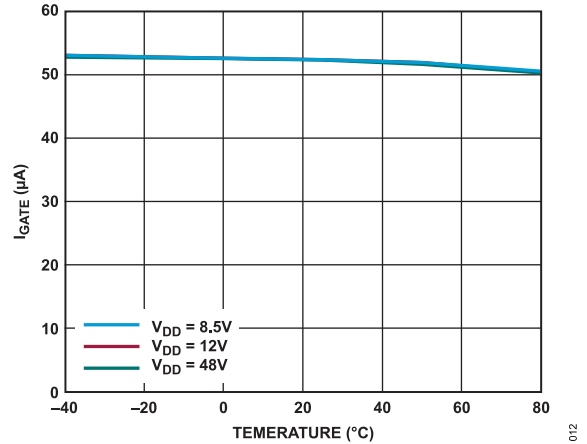

Figure 12. I_{GATE} (Up) vs. Temperature

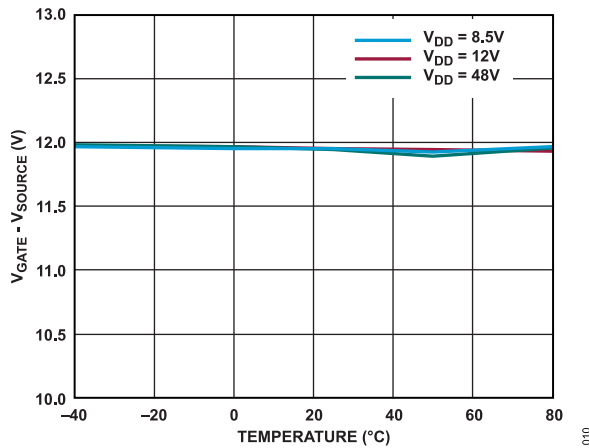

Figure 10. V_{GATE} - V_{SOURCE} vs. Temperature at V_{DD} = 8.5 V, 12 V, and 48 V

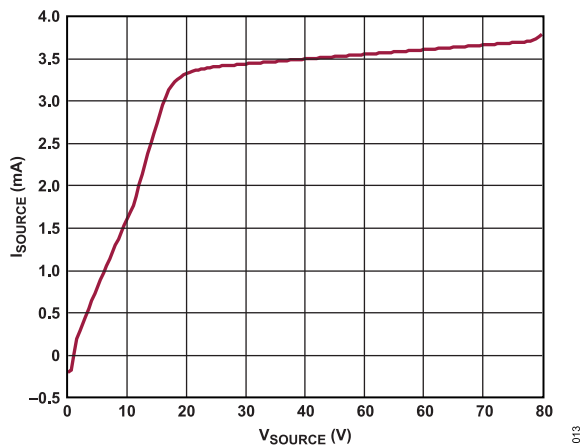

Figure 13. I_{SOURCE} vs. V_{SOURCE}

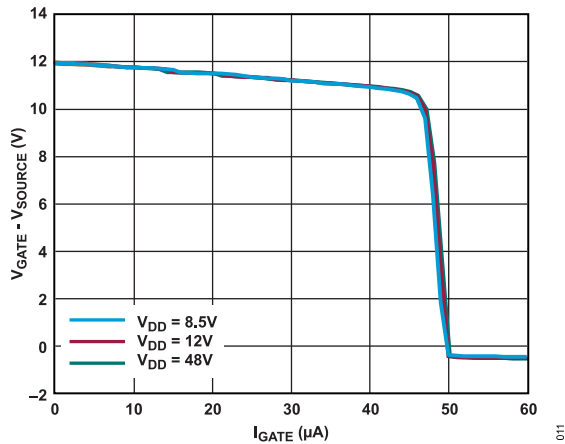

Figure 11. V_{GATE} - V_{SOURCE} vs. I_{GATE} (Leak) at V_{DD} = 8.5 V, 12 V, and 48 V

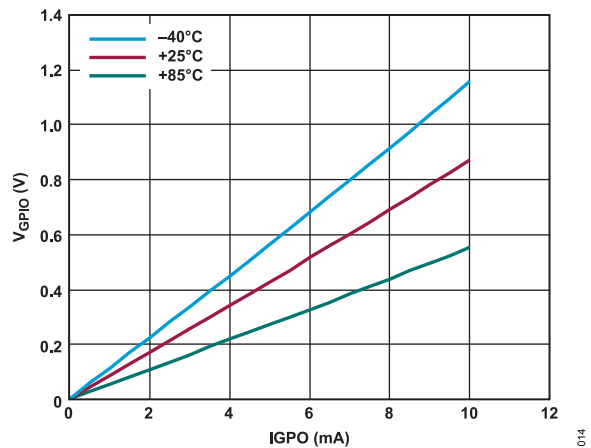

Figure 14. V_{OL} GPIO1, GPIO2, GPIO6 vs. IGPO

TYPICAL PERFORMANCE CHARACTERISTICS

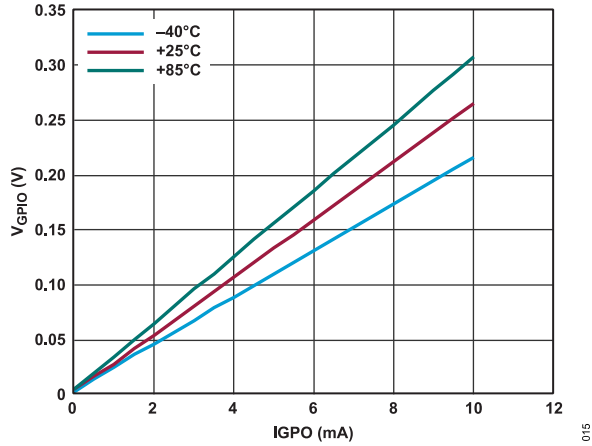

Figure 15. V_{OL} GPIO3, GPIO5, GPIO7 vs. IGPO

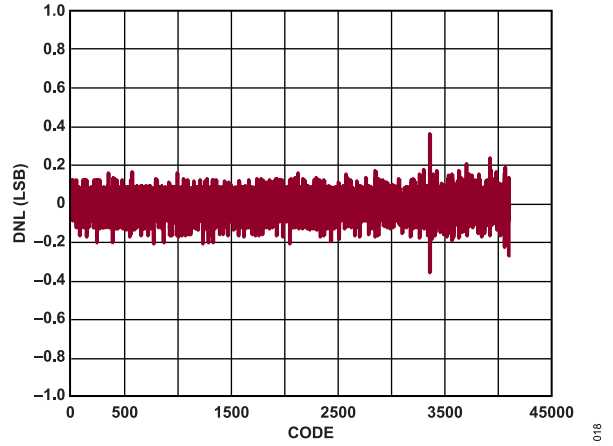

Figure 18. ADC DNL vs. Code (64x Average)

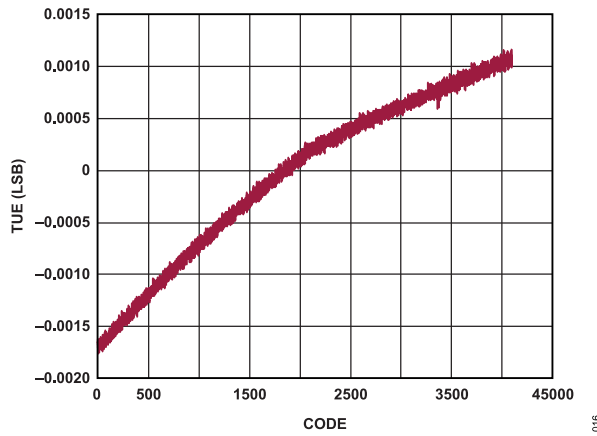

Figure 16. ADC TUE vs. Code (64x Average)

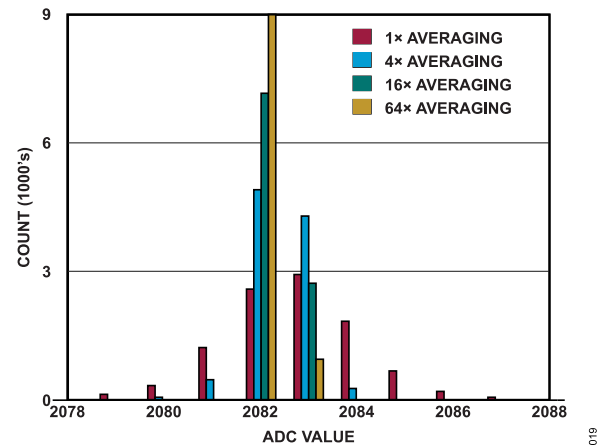

Figure 19. 12-Bit Current ADC Noise Histogram (1x, 4x, 16x, and 64x Average)

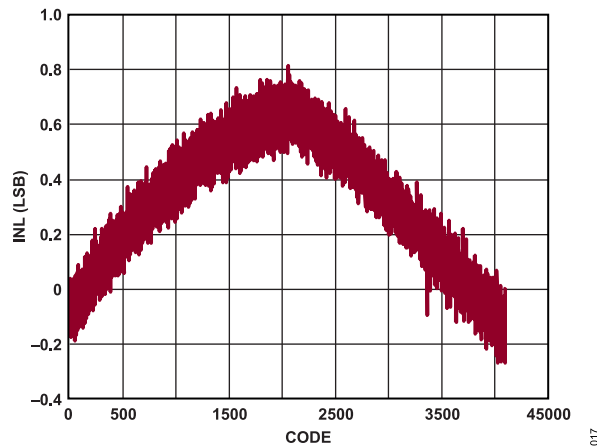

Figure 17. ADC INL vs. Code (64x Average)

THEORY OF OPERATION

The LTC4286 is designed to turn a board's supply voltage on and off in a controlled manner, allowing the board to be safely inserted or removed from a live backplane. During normal operation, the charge pump and gate driver turn on an external N-channel MOSFET gate to pass power to the load. The gate driver uses a charge pump that derives its power from the V_{DD} pin. Also, included in the gate driver is an internal 14 V GATE to SOURCE clamp to protect the oxide of the external MOSFET.

In normal operation, the LTC4286 turns on the external N-channel MOSFET after a startup debounce delay, passing power to the load. A precise current limit value can be set from 6 mV to 20 mV in 2 mV steps using ISET voltage or bits in the MFR_CONFIG1 register. During startup, the voltage between SENSE+ and SENSE- is controlled to be no higher than the current limit threshold with foldback (α). The startup current may be set to even lower values with an external gate RC network.

An overcurrent fault at the output may result in excessive MOSFET power dissipation during active current limiting (ACL). To limit this power, the ACL amplifier regulates the voltage between the SENSE+ and SENSE- pins by reducing the gate-to-source voltage in an active control loop when the sense voltage exceeds the current-limit value. When the MOSFET drain to source voltage is high, power dissipation is further reduced by folding back the current limit to 30% of nominal. In the event of a catastrophic output short, fast current limit comparators immediately pull the GATE pin down with 1 A when the sensed current is three times the nominal current-limit.

To prevent MOSFET overheating, the current-limit timeout is set by a capacitor on the TMR pin. The TMR pin is configured to drive a single capacitor and ramp up with 20 μ A when active current limiting is engaged. If the TMR pin reaches its 2.56 V threshold, the

LTC4286 turns off GATE and the IOUT_OC_FAULT bit is set, which causes the FAULT# pin to pull low. Then the TMR pin ramps down using a 5 μ A current source until the voltage drops below 0.2 V. If overcurrent auto-retry is enabled by tying the GPIO2 (configured as FAULT#) pin to the UV pin, the LTC4286 turns on again at the end of the 9.28 s cool-down timer.

The output voltage is monitored using the SOURCE pin and the power good (PG) comparator to determine if the power is available for the load. The power good condition is signaled by the GPIO1 (configured as Power-Good#) pin using an open-drain pull-down transistor.

The LTC4286 includes three ADCs and all operate at 12-bit resolution. One data converter continuously monitors the ADC+ to ADC- voltage, sampling every 1 μ s and producing a 12-bit result of the average sense voltage every 283 μ s. The second data converter is synchronized to the first and measures the SOURCE voltage during the same time period. Every time the first two ADCs finish taking a measurement, the sense voltage is multiplied by the measurement of the SOURCE pin to provide a power measurement. The third data converter measures temperature on an external or internal diode with 1°C resolution. The minimum and maximum SOURCE, ADC+ to ADC-, POWER, and TEMP measurements are stored, and optional alerts may be generated if a measurement is above or below user configurable 12-bit thresholds.

A PMBus interface is provided to read the A/D registers. It also allows the host to poll the device and determine if faults have occurred. If any GPIO pin is configured as an ALERT# interrupt, the host is enabled to respond to faults in real time. The PMBus device target address is decoded using the ADR0 and ADR1 pins. These inputs have three states each that decode into a total of nine device addresses.

APPLICATIONS INFORMATION

A typical LTC4286 application is in a high availability system in which a positive voltage supply is distributed to power individual boards. PMBus telemetry includes voltages, currents, and status information including faults to be read by the host. The LTC4286 stores minimum and maximum ADC measurements, calculates power, and can be configured to generate alerts based on meas-

urement results, avoiding the need for the system to poll the device on a regular basis. A basic LTC4286 application circuit is shown in Figure 20. The following sections cover turn-on, turn-off, and various faults that the LTC4286 detects and acts upon.

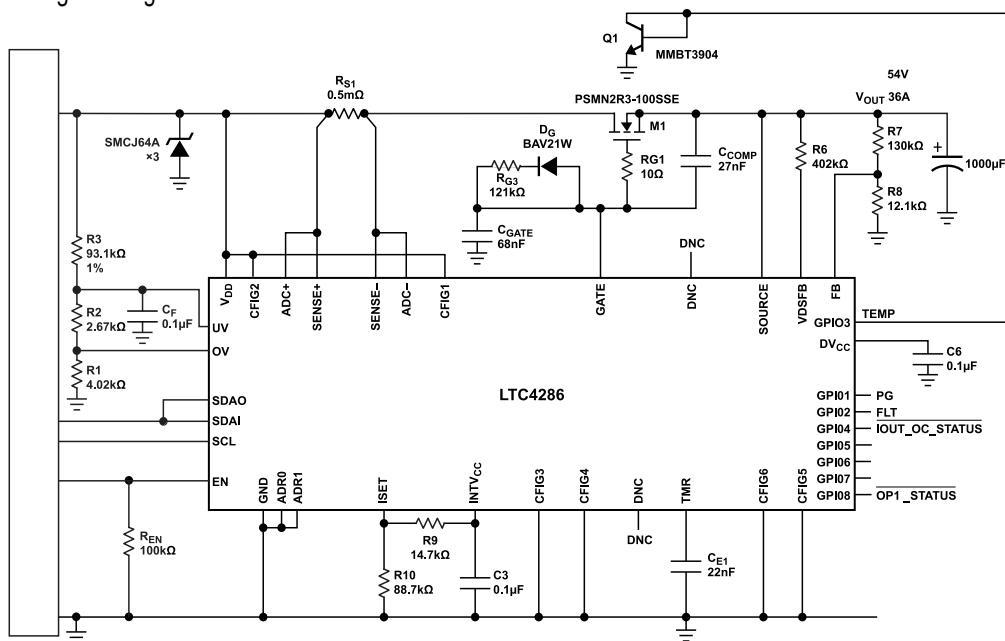

Figure 20. Typical Application

APPLICATIONS INFORMATION

OVERVIEW

The output is controlled by using a N-channel MOSFET, M1, placed in the power path. The resistor RS1 provides the current measurement. The resistive dividers R1, R2, and R3 define undervoltage and overvoltage levels. The UV and OV thresholds can be set using a three resistor dividers. Choose a divider current of at least 200 μ A. $R1 < 2.56 \text{ V}/200 \mu\text{A} = 12.8 \text{ k}\Omega$, then calculate:

$$R2 = \frac{V_{OV(OFF)}}{V_{UV(ON)}} \times R1 \times \frac{UV_{TH(RISING)}}{OV_{TH(FALLING)}} - R1 \quad (1)$$

$$R3 = \frac{V_{UV(ON)} \times (R1 + R2)}{UV_{TH(RISING)}} - R1 - R2 \quad (2)$$

The resistor RG1 prevents high frequency self-oscillations in the MOSFET. R7 and R8 set the power-good threshold, and R6 scales current-limit foldback to the intended operating voltage. The resistive divider, R9 and R10, sets the value of the current limit. For more details, see [Table 5](#).

TURN-ON SEQUENCE

Several conditions must be present before the external MOSFETs turn on. First, the external supply, V_{DD} , must exceed its 6.0 V undervoltage lockout level. Next, the internally generated supplies, $INTV_{CC}$ and DV_{CC} , must cross their 4 V and 2.2 V undervoltage thresholds, respectively. This generates an internal power-on reset signal. After a power-on reset, the UV and OV pins verify that input power is within the acceptable range and the EN pin must be made active to indicate that the board is seated, or the LTC4286 is commanded to turn on. The state of the UV and EN comparators must be stable for at least 90.6 ms to qualify for turn on. When these conditions are satisfied, turn on is initiated. The MOSFET is then turned on by charging up the GATE pin with a 50 μ A current source. When the GATE pin voltage reaches the MOSFET threshold voltage, the MOSFET begins to turn on and the SOURCE voltage then follows the GATE voltage as it increases. The capacitor C_{GATE} limits the dv/dt on the GATE voltage, controlling the inrush current. The inrush current is:

$$I_{INRUSH} = I_{GATE(UP)} \times \frac{C_{LOAD}}{C_{GATE}} \quad (3)$$

Once the MOSFET drain to source voltage is lower than its 2 V threshold, the GATE pin reaches higher than its 8 V threshold, and the FB pin exceeds its 2.56 V threshold, a GPIO pin configured as a power-good output releases high to indicate that power is good and the load can be activated. The CFIG6 pin is used to select if the LTC4286 starts up automatically after power up or waits for a PMBus host controller to command it to turn on. If the CFIG6 pin is grounded, it turns on, if it is set to 1.6 V by a resistive divider, it remains off and wait for further instructions. See [Table 4](#).

Table 4. Using the CFIG6 Pin to Configure the Default On/Off State

CFIG6 at Power-Up	ON Bit
<1 V	On
>1 V, <2.56 V	Off

At the minimum input supply voltage of 8.5 V, the minimum GATE-to-SOURCE driver voltage is 10 V. The GATE-to-SOURCE voltage is clamped below 13.5 V to protect the gates of 20 V N-channel MOSFETs. A curve of GATE-to-SOURCE drive (ΔV_{GATE}) vs. V_{DD} is shown in the [Typical Performance Characteristics](#) section.

TURN-OFF SEQUENCE

A normal turn-off sequence is initiated by card withdrawal when the backplane connector short pin connected to EN opens, causing the EN pin to change state. Additionally, several fault conditions turn off the GATE pin. These include an input overvoltage, input undervoltage, overcurrent, or FET-BAD fault. The MOSFET is turned off with 1 mA of current pulling the GATE pin to ground combined with 10 mA from GATE-to-SOURCE. With the MOSFET turned off, the SOURCE and FB voltages drop as the load capacitance discharges. When the FB voltage crosses below its threshold, a GPIO pin configures as a power-good output pulls low to indicate that the output power is no longer good. If the V_{DD} pin falls to less than 5.5 V or $INTV_{CC}$ drops to less than the undervoltage lockout falling threshold of 3.89 V, a fast shut down of the MOSFET is initiated. The GATE pin is then pulled down with 1 A of current to the SOURCE pin.

Overcurrent Fault Condition

The current limit is set by the value of the ILIM bits in the MFR_CONFIG1 register and the value of the current-sense resistor, RS1. In the event of an overcurrent, the power-dissipation in the MOSFET is limited by the foldback profile shown in [Figure 7](#) and [Figure 8](#). Calculate the value of the external resistor, R6:

$$R6 = 10 \text{ k}\Omega \times (V_{IN} - 12 \text{ V}) \quad (4)$$

Examples include the following:

- ▶ $V_{IN} = 12 \text{ V}$, $R_{VDSFB} = 0 \Omega$
- ▶ $V_{IN} = 48 \text{ V}$, $R_{VDSFB} = 365 \text{ k}\Omega$

MOSFET SOA-TIMER CAPACITOR

MOSFET manufacturers specify the safe limits on operating voltage, current, and time as a set of curves referred to as the safe operating area (SOA). The proper timer capacitance must be set to allow the worst-case operating condition to stay within the SOA limits. The worst-case operating condition can be completely charging a large bypass capacitor at the output during start up or riding through a large input step. The capacitor on the TIMER pin must be calculated to ensure that the MOSFET stays within the SOA during normal and fault conditions.

Note that the timer is independent of the current limit. If the current limit is changed, it may be necessary to change the value of the TIMER pin capacitor.

APPLICATIONS INFORMATION

Setting the Current Limit

The current limit is set with a resistive divider on the ISET pin. The ISET pin provides a 2 mV resolution. These options are shown in

Table 5. ISET is only read at power-up or reboots. Changing ISET while operating does not change the current limit. Writing to ILIM while operating changes the current-limit.

Table 5. Configuring Current Limit with the ISET Pin

$\Delta V_{SNS(TH)}$ (mV)	ILIM	V_{ISET} (V)	ISET Thresholds Compared with				
			Lower (V)	Upper (V)	R_{TOP} (k Ω)	R_{BOTTOM} (k Ω)	$R_{BOTTOM}/(R_{TOP} + R_{BOTTOM})$
6	0001	0		0.357	Open	Short	0.000
8	0011	0.714	0.357	1.071	88.7	14.7	0.143
10	0101	1.429	1.071	1.786	73.2	29.4	0.286
12	0111	2.143	1.786	2.5	59.0	44.2	0.429
14	1001	2.857	2.5	3.214	44.2	59.0	0.571
16	1011	3.571	3.214	3.929	29.4	73.2	0.714
18	1101	4.286	3.929	4.643	14.7	88.7	0.857
20	1111	5	4.643		Short	Open	1.000

APPLICATIONS INFORMATION

DATA CONVERTERS

The LTC4286 incorporates a pair of 12-bit Σ - Δ ADCs, and a third data converter, which monitors temperature with a 1°C/LSB. One converter continuously samples the current-sense voltage, while the other monitors the input voltage, output voltage, and the V_{DD} -SOURCE voltage. The Σ - Δ architecture inherently averages signal noise during the measurement period. The second data converter can be configured to measure V_{IN} at the V_{DD} pin, V_{OUT} at the SOURCE pin, and/or the voltage across the MOSFET by selecting related bits in the MFR_ADC_CONFIG register. The data converter full scale is 32 mV for the current-sense voltage, a choice of 102.4 V or 25.6 V for V_{DD} and V_{SOURCE} , 2.56 V for GPIO and 320 mV for the V_{DD} -SOURCE measurement.

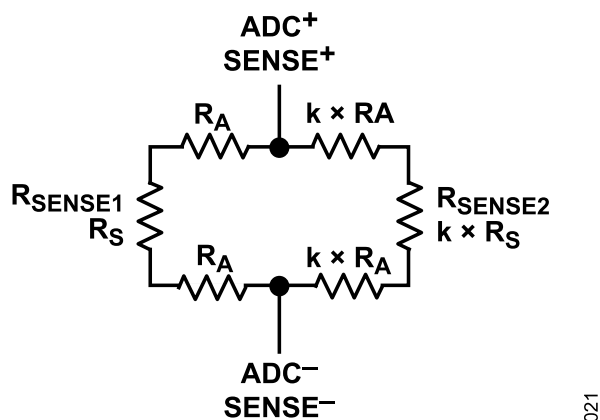

Figure 21. Weighted Averaging Sense Voltages

The ADC+ and ADC- input pins allow the ADC to measure the average voltage across the sense resistor. Some applications may use parallel sense resistors to achieve a specific resistance, in which case averaging resistors can be selected with the same ratio as the sense resistors they connect to, which allows the ADC to still measure current accurately. For more details, see [Figure 21](#). In this case, the effective ADC sense resistor is R_S in parallel with $k \times R_S$ for the current limit. Scaling the averaging resistors, R_A , by the same scaling factor, k , allows the ADC to measure the correct sense voltage for this effective sense resistor. The smallest averaging resistor on the ADC+ or SENSE+ side must not exceed 1 Ω .

Table 6. LTC4286 ADC Measurement Pattern in Continuous Mode, Assuming All AUX Channels Selected

Conversions over Time					
ADC1		ADC1		ADC1	
(ADC+ - ADC-)		(ADC+ - ADC-)		(ADC+ - ADC-)	
ADC2		ADC2		ADC2	
V_{OUT}	V_{IN}	V_{DS}	V_{OUT}	V_{IN}	V_{DS}

The two data converters are synchronized, and after each current measurement conversion, the measured current is multiplied by the measured V_{DD} or V_{SOURCE} , as selected by the VPWR_SELECT bit in the MFR_CONFIG1 register, to yield input or output power. The measurements are compared to the min/max warning thresholds and set the corresponding ADC warning bits in the MFR_SYS-TEM_STATUS2 register and generate an alert if configured to do so in the MFR_STAT2_ALERT_MASK register.

The following formulas are used to convert the values in the ADC result registers into physical units. The data is in twos complement format, left justified, so for 12-bit data the MSB is always 0, and the 3 LSBs are also 0s.

To calculate the input and output voltage, use the following equation:

$$V = \frac{CODE(WORD) \times V_{FS(OUT)}}{2^{15} - 1} \quad (5)$$

where $V_{FS(OUT)}$ is 25.6 V or 102.4 V, depending on the part being in 25 V or 100 V mode, respectively.

To calculate the current in amperes, use the following equation:

$$I = \frac{CODE(WORD) \times 0.032V}{(2^{15} - 1) \times R_{SENSE}} \quad (6)$$

To calculate V_{DD} - SOURCE in volts, use the following equation:

$$V = \frac{CODE(WORD) \times 0.32V}{2^{15} - 1} \quad (7)$$

To calculate power in watts, use the following equation:

$$P = \frac{CODE(WORD) \times 0.032V \times V_{FS(OUT)} \times 2^{15}}{(2^{15} - 1)^2 \times R_{SENSE}} \quad (8)$$

Temperature data is provided in degrees kelvin, as follows:

$$T^{\circ}K = \text{code}$$

$$T^{\circ}C = \text{code} - 273.15$$

APPLICATIONS INFORMATION

Table 7. LTC4286 ADC Measurement Pattern in Continuous Mode, Assuming No AUX Channels Selected

Conversions over Time									
ADC1		ADC1		ADC1		ADC1		ADC1	
(ADC+ – ADC-)		(ADC+ – ADC-)		(ADC+ – ADC-)		(ADC+ – ADC-)		(ADC+ – ADC-)	
ADC2		ADC2		ADC2		ADC2		ADC2	
V _{OUT}	V _{IN}	V _{OUT}	V _{IN}	V _{OUT}	V _{IN}	V _{OUT}	V _{IN}	V _{OUT}	V _{IN}

PMBus specifies M, B, and R constants for use in calculating ADC results. See Table 8 for the LTC4286 M, B, and R parameters.:

Table 8. PMBus M, B, and R Parameters

Parameter	M	R	B
V (102.4 V range)	32	1	0
V (25.6 V range)	128	1	0
I	1024 x R _S ¹	3	0
P (102.4 V range)	R _S	4	0
P (25.6 V range)	4 x R _S	4	0
T°C	1	0	273.15

¹ R_S = value of the current sense resistor in Ω.

Values are calculated as follows:

$$Value = \left(\frac{1}{M}\right) \times Code \times 10^{-R} - B \quad (9)$$

For example, when R_S = 0.333 mΩ,

$$V(code) = 16384 \quad (102.4V \text{ range})$$

$$V = \frac{1}{32} \times 16384 \times 10^{-1} = 51.2V$$

$$I(code) = 16384$$

$$I = \frac{1}{1024/0.333m\Omega} \times 16384 \times 10^{-3} = 48A \quad (10)$$

$$P(code) = 8192$$

$$P = \frac{1}{0.333m\Omega} \times 8192 \times 10^{-4} = 2460W$$

APPLICATIONS INFORMATION

SMBUS SERIAL INTERFACE

- S START CONDITION
- Sr REPEATED START CONDITION
- Rd READ (BIT VALUE OF 1)
- Wr WRITE (BIT VALUE OF 0)
- A NOT ACKNOWLEDGE (HIGH)
- A ACKNOWLEDGE (LOW)
- P STOP CONDITION
- PEC PACKET ERROR CODE
- MASTER TO SLAVE
- SLAVE TO MASTER
- ... CONTINUATION OF PROTOCOL

Figure 22. PMBus Packet Protocol Diagram Element Key

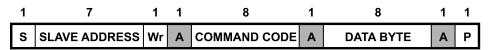

Figure 23. Write Byte Protocol



Figure 24. Write Word Protocol

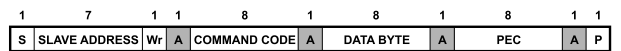

Figure 25. Write Byte Protocol with PEC

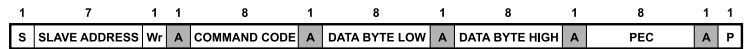

Figure 26. Write Word Protocol with PEC

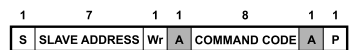

Figure 27. Send Byte Protocol

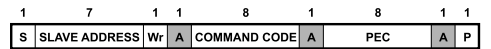

Figure 28. Send Byte Protocol with PEC

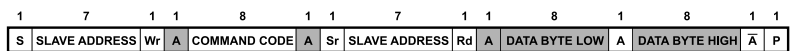

Figure 29. Read Word Protocol

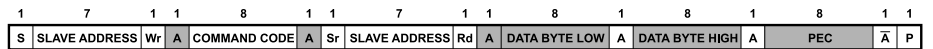

Figure 30. Read Word Protocol with PEC

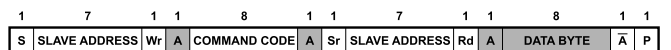

Figure 31. Read Byte Protocol

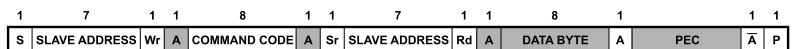

Figure 32. Read Byte Protocol with PEC

APPLICATIONS INFORMATION



Figure 33. Block Read



Figure 34. Block Read with PEC

Table 9. LTC4286 Device Addressing

Description	Hex Device Address		Binary Device Address							LTC4286 Address Pins ¹		
	7-bit†	8-bit ²	6	5	4	3	2	1	0	R/W No.	ADR1	ADR0
Mass Write	0F	1E	0	0	0	1	1	1	1	0	X	X
Alert Response	0C	19	0	0	0	1	1	0	0	1	X	X
0	40	80	1	0	0	0	0	0	0	X	L	L
1	41	82	1	0	0	0	0	0	1	X	L	NC
2	42	84	1	0	0	0	0	1	0	X	L	H
3	43	86	1	0	0	0	0	1	1	X	NC	L
4	44	88	1	0	0	0	1	0	0	X	NC	NC
5	45	8A	1	0	0	0	1	0	1	X	NC	H
6	46	8C	1	0	0	0	1	1	0	X	H	L
7	47	8E	1	0	0	0	1	1	1	X	H	NC
8	11	22	0	0	1	0	0	0	1	X	H	H

¹ H = connect to INTV_{CC}, L = connect to GND, NC = no connect or open, and X = do not care.

² 8-bit hexadecimal address with LSB R/W bit = 0.

APPLICATIONS INFORMATION

PMBUS COMMAND SUMMARY

Table 10. LTC4286 PMBus Command Summary

Command Name	CMD Code	Description	Type ¹	Data Format ²	Unit ²	Default Value ²
PAGE	0x00	Any value can be written to PAGE, but the value is not used by the chip internally. The value written can be read back.	R/W byte	Register	N/A	0x00
OPERATION	0x01	This command requests the hot-swap to turn on or off.	R/W byte	Register	N/A	N/A
CLEAR_FAULTS	0x03	This command clears all latched status bits (all bits shaded in orange or pink in Figure 35). MFR_PMB_STAT and MFR_SD_CAUSE are also cleared by this command.	Send byte	N/A	N/A	N/A
WRITE_PROTECT	0x10	Protect the device against unintended PMBus modifications.	R/W byte	Register	N/A	0x00
CAPABILITY	0x19	Summary of supported optional PMBus features.	R byte	Register	N/A	0xD0
VOUT_OV_WARN_LIMIT	0x42	Sets the overvoltage warning limit for the voltage at V _{OUT} (SOURCE pin).	R/W word	Direct	V	0x7FFF
VOUT_UV_WARN_LIMIT	0x43	Sets the undervoltage warning limit for the voltage at V _{OUT} (SOURCE pin).	R/W word	Direct	V	0 V, 0x0000
IOUT_OC_FAULT_RESPONSE	0x47	Action to be taken by the device when an output overcurrent fault is detected.	R/W byte	Register	N/A	0xC0
IOUT_OC_WARN_LIMIT	0x4A	Sets overcurrent warning limit for I _{OUT} ADC reading.	R/W word	Direct	A	21.3 mV/R _{SENSE} 0x7FFF
OT_FAULT_LIMIT	0x4F	Sets over temperature fault limit for TEMP ADC reading.	R/W word	Direct	°K	0x7FFF
OT_FAULT_RESPONSE	0x50	Action to be taken by the device when an over temperature fault is detected.	R/W byte	Register	N/A	0x80
OT_WARN_LIMIT	0x51	Sets overtemperature warn limit for TEMP ADC reading.	R/W word	Direct	°K	0x7FFF
UT_WARN_LIMIT	0x52	Sets undertemperature warn limit for TEMP ADC reading.	R/W word	Direct	°K	0x0000
VIN_OV_FAULT_RESPONSE	0x56	Action to be taken by the device when an input overvoltage fault is detected.	R/W byte	Register	N/A	0xB8
VIN_OV_WARN_LIMIT	0x57	Sets the overvoltage warning limit for the voltage at the V _{IN} (V _{DD} pin).	R/W word	Direct	V	0x7FFF
VIN_UV_WARN_LIMIT	0x58	Sets the undervoltage warning limit for the voltage at the V _{IN} (V _{DD} pin).	R/W word	Direct	V	0 V, 0x0000
VIN_UV_FAULT_RESPONSE	0x5A	Action to be taken by the device when an input undervoltage fault is detected.	R/W byte	Register	N/A	0xB8
PIN_OP_WARN_LIMIT	0x6B	Sets overpower warning limit for P _{IN} ADC reading.	R/W word	Direct	W	2.8/R _{SENSE} 0x7FFF
STATUS_BYTE	0x78	One byte summary of the unit's fault condition.	R/W byte	Register	N/A	0x00
STATUS_WORD	0x79	Two byte summary of the unit's fault condition.	R/W1C word	Register	N/A	0x0000
STATUS_VOUT	0x7A	Provides status information for faults and warnings related to V _{OUT} (SOURCE pin).	R/W1C byte	Register	N/A	0x00
STATUS_IOUT	0x7B	Provides status information for faults and warnings related to I _{OUT} .	R/W1C byte	Register	N/A	0x00
STATUS_INPUT	0x7C	Provides status information for faults and warnings related to V _{IN} and P _{IN} (V _{DD} pin).	R/W1C byte	Register	N/A	0x00
STATUS_TEMPERATURE	0x7D	Provides status information for faults and warnings related to temperature.	R/W1C byte	Register	N/A	0x00
STATUS_CML	0x7E	Provides status information for faults and warnings related to communication faults.	R/W1C byte	Register	N/A	0x00

APPLICATIONS INFORMATION

Table 10. LTC4286 PMBus Command Summary (Continued)

Command Name	CMD Code	Description	Type ¹	Data Format ²	Unit ²	Default Value ²
STATUS_OTHER	0x7F	Other status faults.	R/W1C byte	Register	N/A	0x00
STATUS_MFR_SPECIFIC	0x80	Provides status information for manufacturer specific faults and warnings.	R/W1C byte	Register	N/A	0x00
READ_VIN	0x88	Reads the input voltage V_{IN} (V_{DD} pin).	R word	Direct	V	N/A
READ_VOUT	0x8B	Reads the output voltage V_{OUT} (SOURCE pin).	R word	Direct	V	N/A
READ_IOUT	0x8C	Reads the output current I_{OUT} .	R word	Direct	A	N/A
READ_TEMPERATURE_1	0x8D	Reads the temperature measured by the device.	R word	Direct	°K	N/A
READ_PIN	0x97	Reads the calculated input power, P_{IN} .	R word	Direct	W	N/A
PMBUS_REVISION	0x98	PMBus revision supported. Current revision is 1.3.	R byte	Register	N/A	0x33
MFR_ID	0x99	Returns string identifying the manufacturer of the device.	R block 3 bytes	ASC	N/A	LTC
MFR_MODEL	0x9A	Returns string identifying the specific model of the device.	R block 7 bytes	ASC	N/A	LTC4286
MFR_REVISION	0x9B	Returns string identifying the hardware revision of the device.	R block 1 byte	Binary	N/A	0x10
IC_DEVICE_ID	0xAD	Returns string identifying the specific model of the device.	R block 1 byte	ASC	N/A	LTC4286
IC_DEVICE_REV	0xAE	Returns string identifying the hardware revision of the device.	R block 1 byte	ASC	N/A	0x10
USER_DATA_00	0xB0	Manufacturer reserved for LTPowerPlay [®] .	R/W word	Register	N/A	N/A
USER_DATA_02	0xB2	OEM reserved.	R/W word	Register	N/A	N/A
USER_TIME	0xB9	Cleared at power-on reset, increments at the internal tick timer rate. Can be written to set time.	R/W block 6 bytes	Binary	N/A	0x000000000000
MFR_FLT_CONFIG	0xD2	Selects option for FAULT pin output (GPIO).	R/W byte	Register	N/A	0x00
MFR_FET_FAULT_RESPONSE	0xD6	Action to be taken in response to FET bad condition.	R/W byte	Register	N/A	0x41
MFR_OP_FAULT_RESPONSE	0xD7	Selects device response to overpower fault.	R/W word	Register	N/A	0xFFE0
MFR_ADC_CONFIG	0xD8	Configures ADC mode and channels.	R/W byte	Register	N/A	0x01
MFR_AVG_SEL	0xD9	Select ADC averaging rate, also enable display of averaged values in READ_VIN, READ_VOUT, READ_IOUT and READ_PIN commands.	R/W byte	Register	N/A	0x85
MFR_SYSTEM_STATUS1	0xE0	Provides manufacturer specific status information.	R/W1C word	Register	N/A	N/A
MFR_SYSTEM_STATUS2	0xE1	Provides manufacturer system warning information.	R/W1C word	Register	N/A	N/A
MFR_PMB_STAT	0xE2	Provides detailed status for latest PMBus transfers, which failed.	R/W byte	Register	N/A	0x00
MFR_PADS_LIVE_STATUS	0xE5	State of I/O pads and live status bits.	R word	Register	N/A	N/A
MFR_SPECIAL_ID	0xE7	This register contains the manufacturer ID, 0x7030 for 4286.	R word	Register	N/A	0x7030
MFR_COMMON	0xEF	Manufacturer status bits that are common across multiple LTC chips.	R byte	Register	N/A	N/A
MFR_SD_CAUSE	0xF1	Cause of last hot-swap shut down.	R byte	Register	N/A	0x00
MFR_CONFIG1	0xF2	Configures current limit, voltage range for V_{IN} and V_{OUT} and calculated power input.	R/W word	Register	N/A	0x5572
MFR_CONFIG2	0xF3	Miscellaneous configuration.	R/W word	Register	N/A	0x00EF
MFR_GPIO_INV	0xF4	Sets polarity of the GPIO inputs and outputs.	R/W word	Register	N/A	0x009B
MFR_GPO_SEL41	0xF5	Configures the GPIO1, GPIO2, GPIO3, and GPIO4 output functions.	R/W word	Register	N/A	0x5F43
MFR_GPO_SEL85	0xF6	Configures the GPIO5, GPIO6, GPIO7, and GPIO8 output functions.	R/W word	Register	N/A	0x8207
MFR_GPI_SEL	0xF7	Configures the GPIO1 to GPIO8 input functions.	R/W word	Register	N/A	0x0005

APPLICATIONS INFORMATION

Table 10. LTC4286 PMBus Command Summary (Continued)

Command Name	CMD Code	Description	Type ¹	Data Format ²	Unit ²	Default Value ²
MFR_GPI_DATA	0xF8	Input values for the GPIO1 to GPIO8.	R byte	Register	N/A	N/A
MFR_GPO_DATA	0xF9	Output values for the GPIO1 to GPIO8.	R/W byte	Register	N/A	0xFF
MFR_REBOOT_CONTROL	0xFD	Enables reboot and configures initialization options.	R/W byte	Register	N/A	0x00
MFR_IOUT	0xFE00	I _{OUT} value, no averaging.	R word	Direct	A	N/A
MFR_IOUT_UC_LIMIT	0xFE04	Limit for I _{OUT} undercurrent warning.	R/W word	Direct	A	0x0000
MFR_IOUT_OC_LIMIT	0xFE05	Limit for I _{OUT} overcurrent warning.	R/W word	Direct	A	0x7FFF
MFR_PIN	0xFE08	PIN value, no averaging.	R word	Direct	W	N/A
MFR_PIN_UP_LIMIT	0xFE0C	Limit for P _{IN} underpower warning.	R/W word	Direct	W	0x0000
MFR_PIN_OP_LIMIT	0xFE0D	Limit for P _{IN} overpower warning.	R/W word	Direct	W	0x7FFF
MFR_VIN	0xFE10	V _{IN} value, no averaging.	R word	Direct	V	N/A
MFR_VIN_UV_LIMIT	0xFE14	Limit for V _{IN} undervoltage warning.	R/W word	Direct	V	0x0000
MFR_VIN_OV_LIMIT	0xFE15	Limit for V _{IN} overvoltage warning.	R/W word	Direct	V	0x7FFF
MFR_VOUT	0xFE18	V _{OUT} value, no averaging.	R word	Direct	V	N/A
MFR_VOUT_UV_LIMIT	0xFE1C	Limit for V _{OUT} undervoltage warning.	R/W word	Direct	V	0x0000
MFR_VOUT_OV_LIMIT	0xFE1D	Limit for V _{OUT} overvoltage warning.	R/W word	Direct	V	0x7FFF
MFR_VDS	0xFE20	V _{DS} value, no averaging.	R word	Direct	V	N/A
MFR_VDS_UV_LIMIT	0xFE24	Limit for V _{DS} undervoltage warning.	R/W word	Direct	V	0x0000
MFR_VDS_OV_LIMIT	0xFE25	Limit for V _{DS} overvoltage warning.	R/W word	Direct	V	0x7FFF
MFR_TEMP	0xFE48	TEMP value, no averaging.	R word	Direct	°K	N/A
MFR_TEMP_UT_LIMIT	0xFE4C	Limit for TEMP undertemperature warning.	R/W word	Direct	°K	0x0000
MFR_TEMP_OT_LIMIT	0xFE4D	Limit for TEMP overtemperature warning.	R/W word	Direct	°K	0x7FFF
MFR_PIN_OP1_FAULT_LIMIT	0xFE58	Limit for P _{IN} over-power timed fault.	R/W word	Direct	W	0x7FFF
MFR_PIN_OP2_FAULT_LIMIT	0xFE59	Limit for P _{IN} over-power immediate fault.	R/W word	Direct	W	0x7FFF
MFR_STATUS_BYTE	0xFEC0	One byte summary of the unit's fault condition.	R/W1S byte	Register	N/A	0x00
MFR_STATUS_WORD_HIGH	0xFEC1	Upper byte of STATUS_WORD.	R/W1S byte	Register	N/A	0x00
MFR_STATUS_VOUT	0xFEC2	Provides status information for faults and warnings related to V _{OUT} (SOURCE pin).	R/W1S byte	Register	N/A	0x00
MFR_STATUS_IOUT	0xFEC3	Provides status information for faults and warnings related to I _{OUT} .	R/W1S byte	Register	N/A	0x00
MFR_STATUS_INPUT	0xFEC4	Provides status information for faults and warnings related to V _{IN} and P _{IN} (V _{DD} pin).	R/W1S byte	Register	N/A	0x00
MFR_STATUS_TEMP	0xFEC5	Provides status information for faults and warnings related to temperature.	R/W1S byte	Register	N/A	0x00
MFR_STATUS_CML	0xFEC6	Provides status information for faults and warnings related to communication faults.	R/W1S byte	Register	N/A	0x00
MFR_STATUS_OTHER	0xFEC7	Other status faults.	R/W1S byte	Register	N/A	0x00
MFR_SPECIFIC_STATUS	0xFEC8	Provides status information for manufacturer specific faults and warnings.	R/W1S byte	Register	N/A	0x00
MFR_SYS_STAT1_SET	0xFECA	Provides manufacturer specific status information.	R/W1S word	Register	N/A	0x0000
MFR_SYS_STAT2_SET	0xFECC	Provides manufacturer system warning information.	R/W1S word	Register	N/A	0x0000
MFR_BYTE_ALERT_MASK	0xFED0	Alert mask for STATUS_BYTE.	R/W byte	Register	N/A	0x80
MFR_VOUT_ALERT_MASK	0xFED2	Alert mask for STATUS_VOUT.	R/W byte	Register	N/A	0x60
MFR_IOUT_ALERT_MASK	0xFED3	Alert mask for STATUS_IOUT.	R/W byte	Register	N/A	0xA0
MFR_INPUT_ALERT_MASK	0xFED4	Alert mask for STATUS_INPUT.	R/W byte	Register	N/A	0xF1
MFR_TEMP_ALERT_MASK	0xFED5	Alert mask for STATUS_TEMPERATURE.	R/W byte	Register	N/A	0xE0
MFR_CML_ALERT_MASK	0xFED6	Alert mask for STATUS_CML.	R/W byte	Register	N/A	0xE3
MFR_SPECIFIC_ALERT_MASK	0xFED8	Alert mask for STATUS_MFR_SPECIFIC.	R/W byte	Register	N/A	0xFF

APPLICATIONS INFORMATION**Table 10. LTC4286 PMBus Command Summary (Continued)**

Command Name	CMD Code	Description	Type ¹	Data Format ²	Unit ²	Default Value ²
MFR_STAT1_ALERT_MASK	0xFEDA	Alert mask for MFR_SYSTEM_STATUS1.	R/W word	Register	N/A	0x3CFE
MFR_STAT2_ALERT_MASK	0xFEDC	Alert mask for MFR_SYSTEM_STATUS2.	R/W word	Register	N/A	0xCFFF

¹ R = read only, R/W = read or write, R/W1C = read or write 1s to clear, and R/W1S = read or write 1s to set.

² N/A = not applicable.

APPLICATIONS INFORMATION

ADC-RELATED COMMANDS AND ALIASES

PMBus defines command codes for several ADC values and warning limits. The LTC4286 uses these command codes, which are defined. Many additional ADC-related commands are not defined as PMBus standard.

The MFR command area above 0xFE00 is arranged orthogonally to allow addressing ADC-related values, both PMBus standard

and LTC4286 specific. This leads to multiple command names for the same internal register in many cases. Results are the same whether a PMBus standard command or its MFR alias is accessed.

The five READ_PMBus standard commands respond with either averaged or non-averaged ADC data. This depends on the setting of DISP_AVG in MFR_AVG_SEL. In the MFR area, non-averaged ADC results are available at any time at separate commands.

Table 11. PMBus ADC-Related Commands and MFR Aliases

PMBus Command	Code	MFR Alias	Code
VOUT_OV_WARN_LIMIT	0x42	MFR_VOUT_OV_LIMIT	0xFE1D
VOUT_UV_WARN_LIMIT	0x43	MFR_VOUT_UV_LIMIT	0xFE1C
IOUT_OC_WARN_LIMIT	0x4A	MFR_IOUT_OC_LIMIT	0xFE05
OT_WARN_LIMIT	0x51	MFR_TEMP_OT_LIMIT	0xFE4D
UT_WARN_LIMIT	0x52	MFR_TEMP_UT_LIMIT	0xFE4C
VIN_OV_WARN_LIMIT	0x57	MFR_VIN_OV_LIMIT	0xFE15
VIN_UV_WARN_LIMIT	0x58	MFR_VIN_UV_LIMIT	0xFE14
PIN_OP_WARN_LIMIT	0x6B	MFR_PIN_OP_LIMIT	0xFE0D
READ_VIN	0x88	MFR_VIN	0xFE10
READ_VOUT	0x8B	MFR_VOUT	0xFE18
READ_IOUT	0x8C	MFR_IOUT	0xFE00
READ_TEMPERATURE_1	0x8D	MFR_TEMP	0xFE48
READ_PIN	0x97	MFR_PIN	0xFE08

Table 12. OPERATION (0x01) R/W

Bit	Name	Default	Operation
7	ON Bit	Not applicable	Indicates On/Off Command of FET, 1 = FET Commanded On, 0 = FET Commanded Off. A 0-to-1 edge for this bit clears all orange and pink shaded bits in Figure 35. At power-up reset or reboot, the ON bit is selected based on the CFG6 input. EN must also be high to turn on.
[6:0]	Reserved	0000000	Always returns 0000000.

Table 13. WRITE_PROTECT (0x10) R/W

Bit	Name	Default	Operation
7	WP1	0	Disables all writes except WRITE_PROTECT and PAGE commands, 1 = disable writes, 0 = enable writes.
6	WP2	0	Disables all writes except WRITE_PROTECT, PAGE, OPERATION, and CLEAR_FAULTS commands, 1 = disable writes, 0 = enable writes.
[5:0]	Reserved	000000	Always returns 000000.

Table 14. CAPABILITY (0x19) Read Only

Bit	Name	Default	Operation
7	PEC	1	Indicates that PEC supported.
[6:5]	MAX_BUS_SPEED	10	Indicates that 1 MHz max bus speed supported.
4	SMBALERT#	1	Indicates that SMBus Alert response supported.
3	IEEE	0	Indicates that numeric data is linear or direct format.
2	AVSBUS	0	Indicates that AVSBUS not supported.
[1:0]	Reserved	00	Always returns 00.

APPLICATIONS INFORMATION

Table 15. IOUT_OC_FAULT_RESPONSE (0x47) R/W

Bit	Name	Default	Operation	
[7:6]	OC_FAULT_RESPONSE	11	Configures Response options for OC fault.	
			Value	Meaning
			00	Ignore fault.
			11	Device shuts down and responds according to retry settings.
[5:3]	OC_FAULT_RETRY	000	Configures Retry options for OC fault.	
			Value	Meaning
			000	Latchoff
			001	1 retry
			010	2 retries
			011	3 retries
			100	4 retries
			101	5 retries
			110	6 retries
			111	∞ retries
[2:0]	Reserved	000	Always returns 000.	

Table 16. OT_FAULT_RESPONSE (0x50) R/W

Bit	Name	Default	Operation	
[7:6]	OT_FAULT_RESPONSE	10	Configures Response options for OT fault.	
			Value	Meaning
			00	Ignore fault.
			10	Device shuts down and responds according to retry settings.
[5:3]	OT_FAULT_RETRY	000	Configures Retry options for OT fault.	
			Value	Meaning
			000	Latchoff
			001	1 retry
			010	2 retries
			011	3 retries
			100	4 retries
			101	5 retries
			110	6 retries
			111	∞ retries
[2:0]	Reserved	000	Always returns 000.	

Table 17. VIN_OV_FAULT_RESPONSE (0x56) R/W

Bit	Name	Default	Operation	
[7:6]	VIN_OV_FAULT_RESPONSE	10	Configures Response options for OV fault.	
			Value	Meaning
			00	Ignore fault.
			10	Device shuts down and responds according to retry settings.
[5:3]	VIN_OV_FAULT_RETRY	111	Configures Retry options for OV fault.	
			Value	Meaning
			000	Latchoff
			001	1 retry
			010	2 retries

APPLICATIONS INFORMATION

Table 17. VIN_OV_FAULT_RESPONSE (0x56) R/W (Continued)

Bit	Name	Default	Operation	
			011	3 retries
			100	4 retries
			101	5 retries
			110	6 retries
			111	∞ retries
[2:0]	Reserved	000	Always returns 000.	

Table 18. VIN_UV_FAULT_RESPONSE (0x5A) R/W

Bit	Name	Default	Operation	
[7:6]	VIN_UV_FAULT_RESPONSE	10	Configures Response options for UV fault.	
			Value	Meaning
			00	Ignore fault.
			10	Device shuts down and responds according to retry settings.
[5:3]	VIN_UV_FAULT_RETRY	111	Configures Retry options for UV fault.	
			Value	Meaning
			000	Latchoff
			001	1 retry
			010	2 retries
			011	3 retries
			100	4 retries
			101	5 retries
			110	6 retries
			111	∞ retries
[2:0]	Reserved	000	Always returns 000.	

APPLICATIONS INFORMATION

STATUS REGISTER SUMMARY

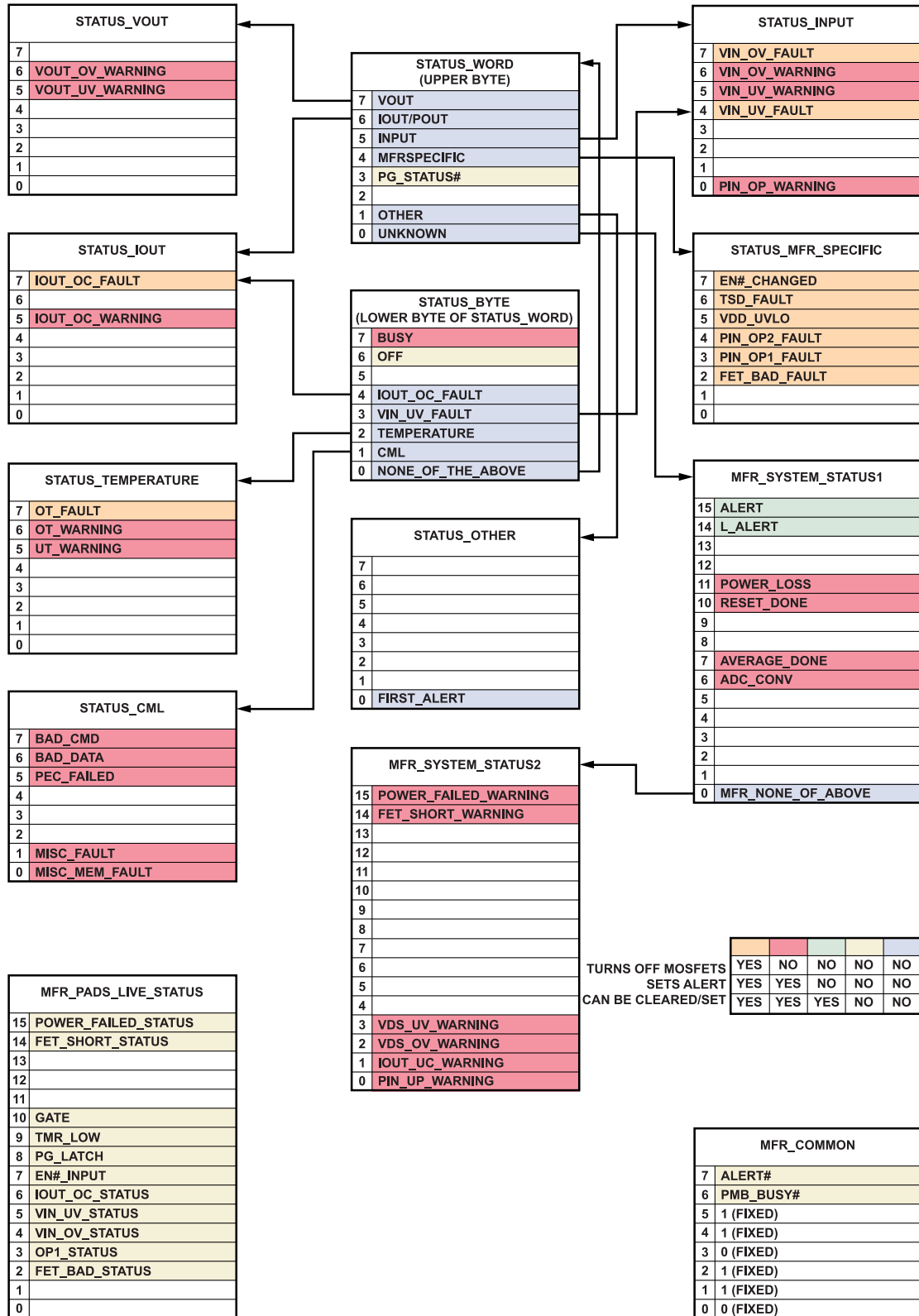

Figure 35. LTC4286 Status Register Summary

APPLICATIONS INFORMATION

LATCHED STATUS AND MASK COMMANDS

Overview

Latched status is kept in the following command locations:

- ▶ STATUS_BYTE
- ▶ STATUS_WORD
- ▶ STATUS_VOUT
- ▶ STATUS_IOUT
- ▶ STATUS_INPUT
- ▶ STATUS_TEMPERATURE
- ▶ STATUS_CML
- ▶ STATUS_OTHER
- ▶ STATUS_MFR_SPECIFIC
- ▶ MFR_SYSTEM_STATUS1
- ▶ MFR_SYSTEM_STATUS2

The status bits have three categories:

- ▶ Faults: conditions that cause GATE to turn off.
- ▶ Warnings: conditions, which can lead to a fault.
- ▶ Events: errors and other information, not related to faults.

Once set, each status bit remains set until one of the following occurs:

- ▶ A chip reset or reboot.
- ▶ A CLEAR_FAULTS command clears them all.
- ▶ The ON bit in the OPERATION command is cleared then set again.
- ▶ At an active edge of EN, all status bits are cleared if RESET_FAULT_ENABLE is set in MFR_CONFIG2.
- ▶ A 1 bit is written to the corresponding location in the status command to clear it.

The LTC4286 also provides a method for software to set latched status bits. To support this, a parallel list of commands is defined. Writing a 1 bit to these commands set the corresponding status bits.

Each of the latched status bits is able to generate an SMBus alert condition by pulling down on a selected open-drain output (for more details, see [Table 19](#)).

Status bits are combined with corresponding mask bits before activating the alert. If the mask bit is 1, the status bit does not contribute to the alert. The LTC4286 power-on default is for all status bits to be masked off, preventing alert indication. Software can write the mask commands to unmask selected status bits.

The [Table 19](#) shows how the commands for latched status are related.

Table 19. Latched Status Commands

Main (R/W1C)	Code	Mirror (R/W1S)	Code	Mask (R/W) ¹	Code ¹
STATUS_BYTE	0x78	MFR_STATUS_BYTE	0xFEC0	MFR_BYTE_ALERT_MASK	0xFED0
STATUS_WORD	0x79	MFR_STATUS_BYTE MFR_STATUS_WORD_HIGH	0xFEC0 0xFEC1	MFR_BYTE_ALERT_MASK	0xFED0
STATUS_VOUT	0x7A	MFR_STATUS_VOUT	0xFEC2	MFR_VOUT_ALERT_MASK	0xFED2
STATUS_IOUT	0x7B	MFR_STATUS_IOUT	0xFEC3	MFR_IOUT_ALERT_MASK	0xFED3
STATUS_INPUT	0x7C	MFR_STATUS_INPUT	0xFEC4	MFR_INPUT_ALERT_MASK	0xFED4
STATUS_TEMPERATURE	0x7D	MFR_STATUS_TEMP	0xFEC5	MFR_TEMP_ALERT_MASK	0xFED5
STATUS_CML	0x7E	MFR_STATUS_CML	0xFEC6	MFR_CML_ALERT_MASK	0xFED6
STATUS_OTHER	0x7F	MFR_STATUS_OTHER	0xFEC7	N/A	N/A
STATUS_MFR_SPECIFIC	0x80	MFR_SPECIFIC_STATUS	0xFEC8	MFR_SPECIFIC_ALERT_MASK	0xFED8
MFR_SYSTEM_STATUS1	0xE0	MFR_SYS_STAT1_SET	0xFECA	MFR_STAT1_ALERT_MASK	0xFEDA
MFR_SYSTEM_STATUS2	0xE1	MFR_SYS_STAT2_SET	0xFECC	MFR_STAT2_ALERT_MASK	0xFEDC

¹ N/A = not applicable.

Table 20. STATUS_BYTE (0x78) W1C, MFR_STATUS_BYTE (0xFEC0) W1S, MFR_BYTE_ALERT_MASK (0xFED0) R/W

Bit	Name	Default 0x78, 0xFEC0	Default 0xFED0	Operation
7	BUSY	0	1	Bit set if the device was busy and cannot respond to a PMBus access.
6	OFF	0	RO/0	Hot-swap gate is off, 1 = gate is disabled, 0 = gate is enabled.
5	Reserved	0	RO/0	Always returns 0.
4	IOUT_OC_FAULT	0	RO/0	Copy of IOUT_OC_FAULT bit in STATUS_IOUT.

APPLICATIONS INFORMATION

Table 20. STATUS_BYTE (0x78) W1C, MFR_STATUS_BYTE (0xFEC0) W1S, MFR_BYTE_ALERT_MASK (0xFED0) R/W (Continued)

Bit	Name	Default 0x78, 0xFEC0	Default 0xFED0	Operation
3	VIN_UV_FAULT	0	RO/0	Copy of VIN_UV_FAULT in STATUS_VIN.
2	TEMPERATURE	0	RO/0	Temperature fault or warning, 1 = there are one or more active status bits in the STATUS_TEMPERATURE (7D), 0 = There are no active status bits.
1	CML	0	RO/0	CML fault or warning, 1 = there are one or more active status bits in the STATUS_CML (7E), 0 = There are no active status bits.
0	NONE_OF_THE_ABOVE	0	RO/0	None of the above, 1 = one or more status bits not listed in bits [7:1] are set.

Table 21. STATUS_WORD (0x79) R/W1C, MFR_STATUS_BYTE/MFR_STATUS_WORD_HIGH (0xFEC0/0xFEC1) R/W1S, MFR_BYTE_ALERT_MASK (0xFED0) R/W

Bit	Name	Default 0x79, 0xFEC0	Default 0xFED0 (Byte Register)	Operation
15	VOUT	0	N/A	V _{OUT} (SOURCE pin) fault or warning, 1 = there are one or more active status bits in the STATUS_VOUT (0X7A), 0 = There are no active status bits.
14	IOUT	0	N/A	I _{OUT} current fault or warning, 1 = there are one or more active status bits in the STATUS_IOUT (0X7B), 0 = There are no active status bits.
13	INPUT	0	N/A	V _{IN} (V _{DD} pin) status warning, 1 = there are one or more active status bits in the STATUS_INPUT (0x7C), 0 = There are no active status bits.
12	MFRSPECIFIC	0	N/A	Manufacture specific fault or warning, 1 = there are one or more active faults, bits [7:3] in the STATUS_MFR_SPECIFIC (0x80), 0 = There are no active fault bits.
11	PG_STATUS#	0	N/A	Bit is high if FB input pin is below 2.56 V, indicating the MOSFET output voltage is not high enough for PG_LATCH status.
10	Reserved	0	N/A	Always returns 0.
9	OTHER	0	N/A	Status is present in STATUS_OTHER byte.
8	UNKNOWN	0	N/A	Bit is high to indicate one or more bits in MFR_SYSTEM_STATUS1 are set.
7	BUSY	0	1	Bit set if the device was busy and could not respond to a PMBus access.
6	OFF	0	RO/0	Hot-swap gate is off, 1 = gate is disabled, 0 = gate is enabled.
5	Reserved	0	RO/0	Always returns 0.
4	IOUT_OC_FAULT	0	RO/0	Copy of IOUT_OC_FAULT bit in STATUS_IOUT.
3	VIN_UV_FAULT	0	RO/0	Copy of VIN_UV_FAULT in STATUS_VIN.
2	TEMPERATURE	0	RO/0	Temperature fault or warning, 1 = there are one or more active status bits in the STATUS_TEMPERATURE (7Dh), 0 = There are no active status bits.
1	CML	0	RO/0	CML fault or warning, 1 = there are one or more active status bits in the STATUS_CML (7Eh), 0 = There are no active status bits.
0	NONE_OF_THE_ABOVE	0	RO/0	None of the above, 1 = one or more status bits not listed in bits [7:1] are set.

Table 22. STATUS_VOUT (0x7A) R/W1C, MFR_STATUS_VOUT (0xFEC2) R/W1S, MFR_VOUT_ALERT_MASK (0xFED2) R/W

Bit	Name	Default 0x7A, 0xFEC2	Default 0xFED2	Operation
7	Reserved	0	RO/0	Always returns 0.
6	VOUT_OV_WARNING	0	1	V _{OUT} overvoltage warning, 1 = detected overvoltage by the VOLTAGE ADC measuring the SOURCE pin, 0 = no OV detected.
5	VOUT_UV_WARNING	0	1	V _{OUT} undervoltage warning, 1 = detected undervoltage by the VOLTAGE ADC measuring the SOURCE pin, 0 = no UV detected.
[4:0]	Reserved	00000	RO/00000	Always returns 00000.

APPLICATIONS INFORMATION

Table 23. STATUS_IOUT (0x7B) R/W1C, MFR_STATUS_IOUT (0xFEC3) R/W1S, MFR_IOUT_ALERT_MASK (0xFED3) R/W

Bit	Name	Default 0x7B, 0xFEC3	Default 0xFED3	Operation
7	IOUT_OC_FAULT	0	1	I _{OUT} overcurrent fault (latched), 1 = detected overcurrent past the TMR pin time limit, 0 = no OC fault detected.
6	Reserved	0	RO/0	Always returns 0.
5	IOUT_OC_WARNING	0	1	I _{OUT} overcurrent warning, 1 = detected overcurrent warning by the CURRENT ADC (V _{SENSE+} - V _{SENSE-}), 0 = no OC detected.
[4:0]	Reserved	00000	RO/00000	Always returns 00000.

Table 24. STATUS_INPUT (0x7C) R/W1C, MFR_STATUS_INPUT (0xFEC4) R/W1S, MFR_INPUT_ALERT_MASK (0xFED4) R/W

Bit	Name	Default 0x7C, 0xFEC4	Default 0xFED4	Operation
7	VIN_OV_FAULT	0	1	V _{IN} overvoltage fault (latched), 1 = detected overvoltage on the OV pin, 0 = no OV detected.
6	VIN_OV_WARNING	0	1	V _{IN} overvoltage warning, 1 = detected overvoltage by the VOLTAGE ADC measuring the V _{DD} pin, 0 = no OV detected.
5	VIN_UV_WARNING	0	1	V _{IN} undervoltage warning, 1 = detected overvoltage by the VOLTAGE ADC measuring the V _{DD} pin, 0 = no UV detected.
4	VIN_UV_FAULT	0	1	V _{IN} undervoltage fault (latched), 1 = detected undervoltage on the UV pin, 0 = no UV detected.
[3:1]	Reserved	000	RO/000	Always returns 000.
0	PIN_OP_WARNING	0	1	Calculated input power, P _{IN} , overpower warning, 1 = detected overpower, 0 = no OP detected.

Table 25. STATUS_TEMPERATURE (0x7D) R/W1C, MFR_STATUS_TEMP (0xFEC5) R/W1S, MFR_TEMP_ALERT_MASK (0xFED5) R/W

Bit	Name	Default 0x7D, 0xFEC5	Default 0xFED5	Operation
7	OT_FAULT	0	1	Overtemperature fault (latched), 1 = detected overtemperature fault by the TEMP ADC, 0 = no OT detected.
6	OT_WARNING	0	1	Overtemperature warning, 1 = detected overtemperature warning by the TEMP ADC, 0 = no OT detected.
5	UT_WARNING	0	1	Undertemperature warning, 1 = detected undertemperature warning by the TEMP ADC, 0 = no UT detected.
[4:0]	Reserved	00000	RO/00000	Always returns 00000.

Table 26. STATUS_CML (0x7E) R/W1C, MFR_STATUS_CML (0xFEC6) R/W1S, MFR_CML_ALERT_MASK (0xFED6), R/W

Bit	Name	Default 0x7E, 0xFEC6	Default 0xFED6	Operation
7	BAD_CMD	0	1	Invalid or unsupported command received.
6	BAD_DATA	0	1	Invalid or unsupported data received.
5	PEC_FAILED	0	1	Packet error check failed, or PEC byte missing where it is required.
4	Reserved	0	0	Always returns 0.
[3:2]	Reserved	00	RO/00	Always returns 00.
1	MISC_FAULT	0	1	Miscellaneous communications fault has occurred.
0	Reserved	0	1	Reserved

Table 27. STATUS_OTHER (0x7F) R/W1C, MFR_STATUS_OTHER (0xFED7) R/W1S

Bit	Name	Default	Operation
[7:1]	Reserved	000000	Always returns 0000000.
0	FIRST_ALERT	0	Bit set if this chip is the first to assert ALERT# low.

APPLICATIONS INFORMATION

Table 28. STATUS_MFR_SPECIFIC (0x80) R/W1C, MFR_SPECIFIC_STATUS (0xFEC8) R/W1S, MFR_SPECIFIC_ALERT_MASK (0xFED8) R/W

Bit	Name	Default 0x80, 0xFEC8	Default 0xFED8	Operation
7	EN_CHANGED	0	1	Indicates that the EN pin changed state; 1 = EN changed state, 0 = EN unchanged.
6	TSD_FAULT	0	1	Latched to a 1 if a thermal shutdown condition is detected, 0 = no thermal shutdown.
5	VDD_UVLO	0	1	Latched to a 1 if the V _{DD} input goes below the V _{DD_UVLO} limit, 0 = no UVLO condition on V _{DD} .
4	PIN_OP2_FAULT	0	1	Indicates that the P _{IN} has exceeded the limit for immediate fault.
3	PIN_OP1_FAULT	0	1	Indicates that the timer has expired for the timed P _{IN} fault limit.
2	FET_BAD_FAULT	0	1	Latched to a 1 if FET Bad Fault occurred, 0 = No FET Bad fault.
1	Reserved	0	1	Reserved for future use.
0	Reserved	0	1	Reserved for future use.

Table 29. MFR_FLT_CONFIG (0xD2) R/W

Bit	Name	Default	Operation
1	OP_TO_FAULT	0	Set to gate overpower fault to the FLT output.
0	OT_TO_FAULT	0	Set to gate overtemperature fault to the FLT output.

Table 30. MFR_FET_FAULT_RESPONSE (0xD6) R/W

Bit	Name	Default	Operation																		
[7:6]	FET_BAD_RESPONSE	01	Configures Response options for FET bad fault. <table border="1"> <thead> <tr> <th>Value</th> <th>Meaning</th> </tr> </thead> <tbody> <tr> <td>00</td> <td>Ignore fault.</td> </tr> <tr> <td>01</td> <td>Device continues for FET_BAD FLT DL. If fault still present, then responds according to retry settings.</td> </tr> </tbody> </table>	Value	Meaning	00	Ignore fault.	01	Device continues for FET_BAD FLT DL. If fault still present, then responds according to retry settings.												
Value	Meaning																				
00	Ignore fault.																				
01	Device continues for FET_BAD FLT DL. If fault still present, then responds according to retry settings.																				
[5:3]	FET_BAD_RETRY	000	Configures Retry options for FET bad fault. <table border="1"> <thead> <tr> <th>Value</th> <th>Warning</th> </tr> </thead> <tbody> <tr> <td>000</td> <td>Latchoff</td> </tr> <tr> <td>001</td> <td>1 retry</td> </tr> <tr> <td>010</td> <td>2 retries</td> </tr> <tr> <td>011</td> <td>3 retries</td> </tr> <tr> <td>100</td> <td>4 retries</td> </tr> <tr> <td>101</td> <td>5 retries</td> </tr> <tr> <td>110</td> <td>6 retries</td> </tr> <tr> <td>111</td> <td>∞ retries</td> </tr> </tbody> </table>	Value	Warning	000	Latchoff	001	1 retry	010	2 retries	011	3 retries	100	4 retries	101	5 retries	110	6 retries	111	∞ retries
Value	Warning																				
000	Latchoff																				
001	1 retry																				
010	2 retries																				
011	3 retries																				
100	4 retries																				
101	5 retries																				
110	6 retries																				
111	∞ retries																				
[2:0]	Reserved	001	Reserved for future use, always write 001.																		

Table 31. MFR_OP_FAULT_RESPONSE (0xD7) R/W

Bit	Name	Default	Operation		
[15:5]	OP_TIMER	1111111111	Timer for OP1 fault. The timer function combines increment and decrement. Each time that P _{IN} is greater than MFR_PIN_OP1_FAULT_LIMIT, an internal counter increments by 2. Each time P _{IN} is less than MFR_PIN_OP1_FAULT_LIMIT that counter decrements by 1. PIN_OP1_FAULT is set if the overpower condition persists for OP_TIMER x 1.13 ms.		
[4:3]	OP_FAULT_RESPONSE	00	Configures Response options for OP1 or OP2 fault. <table border="1"> <thead> <tr> <th>Value</th> <th>Meaning</th> </tr> </thead> </table>	Value	Meaning
Value	Meaning				

APPLICATIONS INFORMATION

Table 31. MFR_OP_FAULT_RESPONSE (0xD7) R/W (Continued)

Bit	Name	Default	Operation																		
			00 10 Ignore fault. Device shut down and responds accordingly to retry settings.																		
[2:0]	OP_FAULT_RETRY	000	Configures Retry options for OP1 or OP2 fault.																		
			<table border="1"> <thead> <tr> <th>Value</th> <th>Meaning</th> </tr> </thead> <tbody> <tr> <td>000</td> <td>Latchoff</td> </tr> <tr> <td>001</td> <td>1 retry</td> </tr> <tr> <td>010</td> <td>2 retries</td> </tr> <tr> <td>011</td> <td>3 retries</td> </tr> <tr> <td>100</td> <td>4 retries</td> </tr> <tr> <td>101</td> <td>5 retries</td> </tr> <tr> <td>110</td> <td>6 retries</td> </tr> <tr> <td>111</td> <td>∞ retries</td> </tr> </tbody> </table>	Value	Meaning	000	Latchoff	001	1 retry	010	2 retries	011	3 retries	100	4 retries	101	5 retries	110	6 retries	111	∞ retries
Value	Meaning																				
000	Latchoff																				
001	1 retry																				
010	2 retries																				
011	3 retries																				
100	4 retries																				
101	5 retries																				
110	6 retries																				
111	∞ retries																				

Table 32. MFR_ADC_CONFIG (0xD8) R/W

Bit	Name	Default	Operation
7	Reserved	0	Reserved for future use. Only write 0.
6	Reserved	0	Always returns 0.
5	Reserved	0	Reserved for future use. Only write 0.
4	Reserved	0	Reserved for future use. Only write 0.
3	Reserved	0	Reserved for future use. Only write 0.
2	Reserved	0	Reserved for future use. Only write 0.
1	VDS_SELECT	0	Enables V_{DS} as an Auxiliary Input for ADC Measurement.
0	VIN_VOUT_SELECT	1	Enables V_{IN} or V_{OUT} as an auxiliary input for ADC Measurement. The choice between the two depends on VPWR_SELECT in MFR_CONFIG1. If V_{IN} is selected in VPWR_SELECT, then V_{OUT} is available as an auxiliary input. In the opposite case, V_{IN} is available as an auxiliary input.

Table 33. MFR_AVG_SEL (0xD9) R/W

Bit	Name	Default	Operation
7	DISP_AVG	1	1 selects averaged values for READ_VIN, READ_VOUT, READ_IOUT and READ_PIN, 0 selects unaveraged values.
[6:4]	Reserved	000	Always returns 000.
[3:0]	ADC_AVERAGE_SELECT	0101	Selects number of ADC samples per average. For more details, see Table 34.

Table 34. ADC_AVERAGE_SELECT Options

Value	Samples	Average Time
0000	2	0.566 ms
0001	4	1.13 ms
0010	8	2.27 ms
0011	16	4.53 ms
0100	32	9.06 ms
0101	64	18.1 ms
0110	128	36.3 ms
0111	256	72.5 ms
1000	512	145 ms
1001	1024	290 ms
1010	2048	580 ms
1011	4096	1.16 sec

APPLICATIONS INFORMATION

Table 34. ADC_AVERAGE_SELECT Options (Continued)

Value	Samples	Average Time
1100	8192	2.32 sec
1101	16384	4.64 sec
1110	32768	9.28 sec
1111	65536	18.6 sec

Table 35. MFR_SYSTEM_STATUS1 (0xE0) R/W1C, MFR_SYS_STAT1_SET (0xFECA) R/W1S, MFR_STAT_ALERT_MASK (0xFEDA) R/W

Bit	Name	Default 0xE0, 0xFECA	Default 0xFEDA	Operation
15	ALERT	0	RO/0	Bit set to 1 when an Alert is generated. This can be cleared via SMBus write or alert response protocol. The bit can be configured to appear as active low or high on any GPIO pin.
14	L_ALERT	0	RO/0	Alternate version of ALERT or latched ALERT. This bit is set by the same conditions that set ALERT. But it can only be cleared by an SMBus write. This bit can be configured to appear on any GPIO pin as L_ALERT# or L_ALERT.
13	Reserved	0	1	Reserved
12	Reserved	0	1	Reserved
11	POWER_LOSS	0	1	Bit is 1 following a power-on reset, or 0 after a reboot-generated reset.
10	RESET_DONE	0	1	Latched status bit is set after each chip reset (either power-on or reboot).
[9:8]	Reserved	00	RO/00	Always returns 00.
7	AVERAGE_DONE	0	1	Set at the completion of an average.
6	ADC_CONV	0	1	Latched to 1 when a full ADC conversion (current and voltage) completes.
5	Reserved	0	1	Reserved
4	Reserved	0	1	Reserved
3	Reserved	0	1	Reserved
2	Reserved	0	1	Reserved
1	Reserved	0	1	Reserved
0	MFR_NONE_OF_ABOVE	0	RO/0	Bit is set if bits in MFR_SYSTEM_STATUS2 are set.

Table 36. MFR_SYSTEM_STATUS2 (0xE1) R/W1C, MFR_SYS_STAT2_SET (0xFECC) R/W1S, MFR_STAT2_ALERT_MASK (0xFEDC) R/W

Bit	Name	Default 0xE1, 0xFECC	Default 0xFEDC	Operation
15	POWER_FAILED_WARNING	0	1	This latched bit is set if POWER_FAILED_STATUS goes active. This happens if the FB input pin goes below 2.56 V while the PG_LATCH status bit is set. That indicates a loss of output voltage after it was initially good.
14	FET_SHORT_WARNING	0	1	Latched to a 1 if measured ($V_{SENSE+} - V_{SENSE-}$) exceeds 2 mV while FET is off (FET Short was detected); 1 = FET Short Fault occurred, 0 = No FET Short fault.
[13:12]	Reserved	00	RO/00	Always returns 00.
11	Reserved	0	1	Reserved for future use. Only write 0.
10	Reserved	0	1	Reserved for future use. Only write 0.
9	Reserved	0	1	Reserved for future use. Only write 0.
8	Reserved	0	1	Reserved for future use. Only write 0.
7	Reserved	0	1	Reserved for future use. Only write 0.
6	Reserved	0	1	Reserved for future use. Only write 0.
5	Reserved	0	1	Reserved for future use. Only write 0.
4	Reserved	0	1	Reserved for future use. Only write 0.
3	VDS_UV_WARNING	0	1	Latched to 1 when the V_{DS} input is below MFR_VDS_MIN_WARN_LIMIT.
2	VDS_OV_WARNING	0	1	Latched to 1 when the V_{DS} input is above MFR_VDS_MAX_WARN_LIMIT.

APPLICATIONS INFORMATION

Table 36. MFR_SYSTEM_STATUS2 (9xE1) R/W1C, MFR_SYS_STAT2_SET (0xFECC) R/W1S, MFR_STAT2_ALERT_MASK (0xFEDC) R/W (Continued)

Bit	Name	Default 0xE1, 0xFECC	Default 0xFEDC	Operation
1	IOUT_UC_WARNING	0	1	Indicates that the I _{OUT} current is below warning limit in MFR_IOUT_UC_WARN_LIMIT.
0	PIN_UP_WARNING	0	1	Indicates that the P _{IN} power is below warning limit in MFR_PIN_UP_WARN_LIMIT.

Table 37. MFR_PMB_STAT (0xE2) R/W

Bit	Name	Operation
[7:5]	Reserved	Always returns 000.
[4:0]	PMB_STATUS	Provides detail for the most recent PMBus transfer, which had a problem. A value of 0 indicates no recorded problem. Once set to a non-zero value, PMB_STATUS holds that value until another PMBus transfer has a problem. Table 38 details the code values. The register can also be written. Writing a non-zero value results on the status bit setting shown in the Table 38.

Table 38. PMB_STATUS Detail

Value	Description	Target Bit
0x01	Chip busy due to previous command	STATUS:BUSY
0x02	Reserved	N/A
0x03	Incoming PEC bad	STATUS_CML:PEC_FAILED
0x04	Repeated start or stop bit received not on byte boundary	STATUS_CML:MISC_FAULT
0x05	Stop bit received before end, no PMBus error	N/A
0x06	Read was NACK'ed before final byte, no PMBus error	N/A
0x07	Host read too many bytes	STATUS_CML:MISC_FAULT
0x08	Host wrote too many bytes	STATUS_CML:BAD_DATA
0x09	Target address with R/W# high rejected	STATUS_CML:MISC_FAULT
0x0A	Bad command code received	STATUS_CML:BAD_CMD
0x0B	Attempt to write invalid data value	STATUS_CML:BAD_DATA
0x0C	Attempt to write a read-only command	STATUS_CML:BAD_DATA
0x0D	Reserved	N/A
0x0E	Reserved	N/A
0x0F	Reserved	N/A
0x10	Reserved	N/A
0x11	Reserved	N/A
0x12	Reserved	N/A
0x13	Byte count for block write incorrect	STATUS_CML:BAD_DATA
0x14	Reserved	N/A
0x15	Read data not available in time	STATUS:BUSY
0x16	SDAO data conflict (another chip pulled down SDA when data was coming from this chip)	STATUS_CML:MISC_FAULT
0x17	SDAO conflict specifically on ARA, no PMBus error	N/A
0x18	Reserved	N/A
0x19	Attempted read of write-only (TX-byte) command	STATUS_CML:MISC_FAULT
0x1A	Reserved	N/A
0x1B	Reserved	N/A
0x1C	Reserved	N/A
0x1D	Reserved	N/A
0x1E	Reserved	N/A
0x1F	Reserved	N/A

APPLICATIONS INFORMATION

Table 39. MFR_PADS_LIVE_STATUS (0xE5) Read Only

Bit	Name	Operation
15	POWER_FAILED_STATUS	POWER_FAILED_STATUS is active when FB input pin goes below 2.56 V while the PG_LATCH status bit is set. That indicates a loss of output voltage after it was initially good.
14	FET_SHORT_STATUS	Indicates that the potential FET short if ($V_{SENSE+} - V_{SENSE-}$) exceeds 2 mV while the external MOSFET is off, 1 = FET shorted, 0 = FET not shorted.
[13:12]	Reserved	Always returns 00.
11	Reserved	Reserved
10	GATE	Indicates that the state of GATE Pin, 1 = GATE Pin high, 0 = GATE Pin low.
9	TMR_LOW	Indicates that whether TMR Pin is Low, 1 = TMR is lower than 0.2 V, 0 = TMR is higher than 0.2 V.
8	PG_LATCH	Latched signal is active when system power seems good. The conditions to set are $FB > 2.56$ V, $V_{GS} > 8$ V, and $V_{DS} < 2$ V. Either FB low or external MOSFET turned off clears PG_LATCH depending on the PWRGD_RESET bit.
7	EN_INPUT	Bit is 1 to indicate that the EN pin is in the active state.
6	IOUT_OC_STATUS	Overcurrent condition from comparator, 1 = Overcurrent, 0 = not overcurrent.
5	VIN_UV_STATUS	Indicates that the input undervoltage when UV pin is low, 1 = UV low, 0 = UV high.
4	VIN_OV_STATUS	Indicates that the input overvoltage when OV pin is high, 1 = OV high, 0 = OV low.
3	OP1_STATUS	Bit is 1 to indicate that the P_{IN} is exceeding the MFR_PIN_OP1_FAULT_LIMIT value. The bit automatically clears when P_{IN} falls below that value.
2	FET_BAD_STATUS	Indicates that the FET Bad condition is present, 1 = FET Bad condition present, 0 = FET Bad condition not present.
1	Reserved	Reserved
0	Reserved	Reserved

Table 40. MFR_COMMON (0xEF) Read Only

Bit	Name	Default	Operation
7	ALERT_LATCH#	1	Bit is 0 when the 4286 is pulling down ALERT#.
6	PMB_BUSY#	1	Bit is 0 when some registers are unavailable for PMBus access.
[5:4]	Reserved	11	Always returns 11.
3	Reserved	0	Reserved
[2:0]	Reserved	110	Always returns 110.

Table 41. MFR_SD_CAUSE (0xF1) Read Only

Bit	Name	Default	Operation																												
[7:4]	Reserved	0000	Always returns 0000.																												
[3:0]	HS_SHUTDOWN_CAUSE	0000	Cause of last hot-swap shut down.																												
			<table border="1"> <thead> <tr> <th>HS_SHUTDOWN_CAUSE[3:0]</th> <th>Cause</th> </tr> </thead> <tbody> <tr> <td>0001</td> <td>OPERATION command</td> </tr> <tr> <td>0010</td> <td>EN pin</td> </tr> <tr> <td>0011</td> <td>REBOOT or restart</td> </tr> <tr> <td>0100</td> <td>INTVCC_UVLO</td> </tr> <tr> <td>0101</td> <td>TSD (thermal shut down)</td> </tr> <tr> <td>0110</td> <td>VDD_UVLO</td> </tr> <tr> <td>0111</td> <td>OT_FAULT</td> </tr> <tr> <td>1000</td> <td>IOUT_OC_FAULT</td> </tr> <tr> <td>1001</td> <td>PIN_OP2_FAULT</td> </tr> <tr> <td>1010</td> <td>PIN_OP1_FAULT</td> </tr> <tr> <td>1011</td> <td>FET_BAD_FAULT</td> </tr> <tr> <td>1100</td> <td>VIN_UV_FAULT</td> </tr> <tr> <td>1101</td> <td>VIN_OV_FAULT</td> </tr> </tbody> </table>	HS_SHUTDOWN_CAUSE[3:0]	Cause	0001	OPERATION command	0010	EN pin	0011	REBOOT or restart	0100	INTVCC_UVLO	0101	TSD (thermal shut down)	0110	VDD_UVLO	0111	OT_FAULT	1000	IOUT_OC_FAULT	1001	PIN_OP2_FAULT	1010	PIN_OP1_FAULT	1011	FET_BAD_FAULT	1100	VIN_UV_FAULT	1101	VIN_OV_FAULT
HS_SHUTDOWN_CAUSE[3:0]	Cause																														
0001	OPERATION command																														
0010	EN pin																														
0011	REBOOT or restart																														
0100	INTVCC_UVLO																														
0101	TSD (thermal shut down)																														
0110	VDD_UVLO																														
0111	OT_FAULT																														
1000	IOUT_OC_FAULT																														
1001	PIN_OP2_FAULT																														
1010	PIN_OP1_FAULT																														
1011	FET_BAD_FAULT																														
1100	VIN_UV_FAULT																														
1101	VIN_OV_FAULT																														

APPLICATIONS INFORMATION

Table 41. MFR_SD_CAUSE (0xF1) Read Only (Continued)

Bit	Name	Default	Operation
			1110 Reserved
			1111 Reserved

Table 42. MFR_CONFIG1 (0xF2) R/W

Bit	Name	Default	Operation						
15	Reserved	0	Always returns 0.						
14	Reserved	1	Reserved, always write 1.						
[13:10]	ILIM	0101	Configures the sense reference voltage for current limit, see Table 5. Configuring current-limit with the ISET pin.						
[9:8]	Reserved	01	Reserved, always write 01.						
7	Reserved	0	Always returns 0.						
[6:5]	Reserved	11	Reserved, always write 11.						
[4:2]	Reserved	100	Reserved, always write 100.						
1	VRANGE_SELECT	1	Selects a voltage range for V_{IN} and V_{OUT} measurements. <table border="1"> <thead> <tr> <th>VRANGE_SEL</th> <th>Voltage Range for V_{IN} and V_{OUT}</th> </tr> </thead> <tbody> <tr> <td>0</td> <td>25.6 V</td> </tr> <tr> <td>1</td> <td>102.4 V</td> </tr> </tbody> </table>	VRANGE_SEL	Voltage Range for V_{IN} and V_{OUT}	0	25.6 V	1	102.4 V
VRANGE_SEL	Voltage Range for V_{IN} and V_{OUT}								
0	25.6 V								
1	102.4 V								
0	VPWR_SELECT	0	Selects voltage for power multiplication (optional). See $V_{IN_VOUT_SELECT}$ bit for interaction with ADC auxiliary input list. <table border="1"> <thead> <tr> <th>VPWR_SELECT</th> <th>Voltage for Power Multiplication</th> </tr> </thead> <tbody> <tr> <td>0</td> <td>V_{IN} (attenuated V_{DD} voltage for input power.)</td> </tr> <tr> <td>1</td> <td>V_{OUT} (attenuated SOURCE voltage for FET power.)</td> </tr> </tbody> </table>	VPWR_SELECT	Voltage for Power Multiplication	0	V_{IN} (attenuated V_{DD} voltage for input power.)	1	V_{OUT} (attenuated SOURCE voltage for FET power.)
VPWR_SELECT	Voltage for Power Multiplication								
0	V_{IN} (attenuated V_{DD} voltage for input power.)								
1	V_{OUT} (attenuated SOURCE voltage for FET power.)								

Table 43. MFR_CONFIG2 (0xF3) R/W

Bit	Name	Default	Operation
[15:14]	Reserved	00	Always returns 00.
13	Reserved	0	Reserved, always write 0.
12	SEL_1M	0	Set bit to enable 1 Mbit-compatible timing for PMBus.
[11:10]	Reserved	00	Reserved, always write 00.
[9:8]	Reserved	00	Reserved, always write 00.
7	RESET_FAULT_ENABLE	1	Enables fault reset on an edge of the EN pin going active. 1 = EN active edge resets fault register bits, 0 = EN active edge has no impact on fault register bits
6	PWRGD_RESET_CNTRL	1	Configures PG_LATCH Reset, 1 = FB Low Resets PG_LATCH, 0 = FET Off Resets PG_LATCH.
5	MASS_WRITE_ENABLE	1	Enables mass Write or global address to this device and others on the SMBus, 1 = Mass Write Enabled, 0 = Mass Write Disabled.
4	Reserved	0	Always returns 0.
3	Reserved	1	Reserved, always write 1.
2	EXT_TEMP_ENABLE	1	Enables the use of an external temperature sensor on GPIO3 (default), falls back to on-chip temperature sensor when disabled.
1	DB_EN_ON_EN	1	Enables use of debounce timer for EN transitions.
0	Reserved	1	Reserved, always write 1.

APPLICATIONS INFORMATION

Table 44. MFR_GPIO_INV (0xF4) R/W

Bit	Name	Default	Operation
[15:10]	Reserved	000000	Reserved for future use, write 0 only.
9	RBT_INV	0	Assigns polarity for GPIO input associated with reboot input, 0 = rising edge of GPIO pin triggers reboot (REBOOT input), 1 = falling edge of GPIO pin triggers reboot (REBOOT# input).
7	INV8	1	Assigns polarity for GPIO8 output, 0 = GPIO8 pin pulls low when specified output bit is low, 1 = GPIO8 pin pulls low when specified output bit is high.
6	INV7	0	Assigns polarity for GPIO7 output, 0 = GPIO7 pin pulls low when specified output bit is low, 1 = GPIO7 pin pulls low when specified output bit is high.
5	INV6	0	Assigns polarity for GPIO6 output, 0 = GPIO6 pin pulls low when specified output bit is low, 1 = GPIO6 pin pulls low when specified output bit is high.
4	INV5	1	Assigns polarity for GPIO5 output, 0 = GPIO5 pin pulls low when specified output bit is low, 1 = GPIO5 pin pulls low when specified output bit is high.
3	INV4	1	Assigns polarity for GPIO4 output, 0 = GPIO4 pin pulls low when specified output bit is low, 1 = GPIO4 pin pulls low when specified output bit is high.
2	INV3	0	Assigns polarity for GPIO3 output, 0 = GPIO3 pin pulls low when specified output bit is low, 1 = GPIO3 pin pulls low when specified output bit is high.
1	INV2	1	Assigns polarity for GPIO2 output, 0 = GPIO2 pin pulls low when specified output bit is low, 1 = GPIO2 pin pulls low when specified output bit is high.
0	INV1	1	Assigns polarity for GPIO1 output, 0 = GPIO1 pin pulls low when specified output bit is low, 1 = GPIO1 pin pulls low when specified output bit is high.

APPLICATIONS INFORMATION

GPIO OUTPUT SELECTION

Table 45. Output Selection

SELn[3:0] ¹	Output
0000	Three-state
0001	MFR_GPO_DATA[n-1]
0010	CMPOUT
0011	PWR_GOOD
0100	FAULT
0101	IOUT_OC_STATUS
0110	Reserved
0111	Reserved
1000	OP1_STATUS
1001	ALERT
1010	L_ALERT
1111	Temperature Sensor (GPIO3 only)

¹ This table is common to all eight GPIO pins with n to be replaced by the GPIO number (1 to 8).

Table 46. MFR_GPO_SEL_41 (0xF5) R/W

Bit	Name	Default	Operation
[15:12]	SEL4[3:0]	0101	Selects a GPIO4 output.
[11:8]	SEL3[3:0]	1111	Selects a GPIO3 output.
[7:4]	SEL2[3:0]	0100	Selects a GPIO2 output.
[3:0]	SEL1[3:0]	0011	Selects a GPIO1 output.

Table 47. MFR_GPO_SEL85 (0xF6) R/W

Bit	Name	Default	Operation
[15:12]	SEL8[3:0]	1000	Selects a GPIO8 output.
[11:8]	SEL7[3:0]	0010	Selects a GPIO7 output.
[7:4]	SEL6[3:0]	0000	Selects a GPIO6 output.
[3:0]	SEL5[3:0]	0111	Selects a GPIO5 output.

Table 48. MFR_GPI_SEL (0xF7) R/W

Bit	Name	Default	Operation												
[15]	Reserved	0	Always returns 0.												
[14:12]	Reserved	000	Reserved for future use, write 000 only.												
11	Reserved	0	Reserved for future use, write 0 only.												
[10:8]	Reserved	000	Reserved for future use, write 000 only.												
7	RBT_EN	0	This bit enables a GPIO pin (configured as REBOOT# or REBOOT) to generate a reboot, turns off the power MOSFETs, waits a programmed delay of 0.5 s to 68 s, and then restarts the MOSFETs to power cycle the load. Optionally, chip reset may occur during the turn-off period.												
[6:4]	RBT_SEL [2:0]	000	Selects a GPIO pin as a reboot trigger (REBOOT# or REBOOT) input.												
3	Reserved	0	Always returns a 0.												
[2:0]	CMP_SEL [2:0]	101	<table border="1"> <thead> <tr> <th>CMP_SEL[2:0]</th> <th>Input</th> </tr> </thead> <tbody> <tr> <td>000</td> <td>GPIO1</td> </tr> <tr> <td>001</td> <td>GPIO2</td> </tr> <tr> <td>010</td> <td>GPIO3</td> </tr> <tr> <td>011</td> <td>GPIO4</td> </tr> <tr> <td>100</td> <td>GPIO5</td> </tr> </tbody> </table>	CMP_SEL[2:0]	Input	000	GPIO1	001	GPIO2	010	GPIO3	011	GPIO4	100	GPIO5
CMP_SEL[2:0]	Input														
000	GPIO1														
001	GPIO2														
010	GPIO3														
011	GPIO4														
100	GPIO5														

APPLICATIONS INFORMATION

Table 48. MFR_GPI_SEL (0xF7) R/W (Continued)

Bit	Name	Default	Operation
			101
			110
			111
			GPIO6
			GPIO7
			GPIO8

Table 49. MFR_REBOOT_CONTROL (0xFD) R/W

Bit	Name	Default	Operation
[7:6]	Reserved	00	Always returns 00.
[5:4]	RBT_INIT	00	Selects chip initialization options following the reboot: 00 = chip is reset. 01 = chip is reset. 10 = no reset. FETs are turned off and then back on after the auto reboot turn-on delay that follows these bits.
3	REBOOT	0	Write a 1 to reboot. This bit is not cleared by the reboot operation so software can check that a reboot just took place.
[2:0]	Reserved	000	Reserved.

TYPICAL APPLICATION

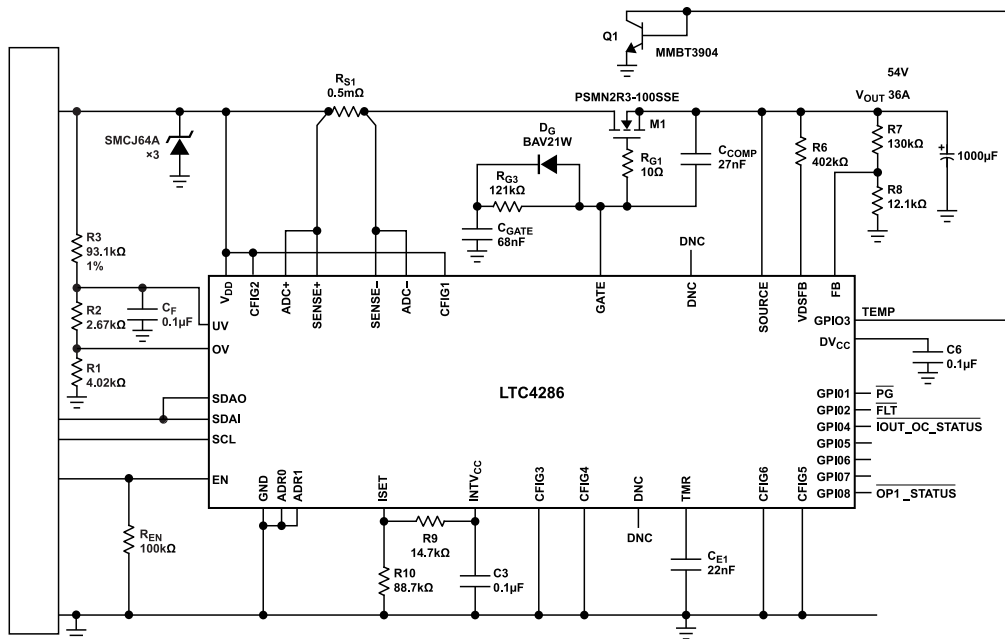

Figure 36. LTC4286 Typical Application

RELATED PARTS

Table 50. Related Part Numbers

Part Number	Description	Comments
LTC4260	Positive high voltage hot-Swap controller with I ² C compatible monitoring	8-bit ADC monitoring current and voltages, supplies from 8.5 V to 80 V, single MOSFET driver.
LTC4238	High voltage high current hot-swap controller	Operates from 6.5 V to 80 V, compatible with LTC4286 with COMM/GPIO5 pins, dual MOSFET drivers.
ADM1272	High voltage positive hot-swap controller and digital power monitor with PMBus	Operates from 16 V to 80 V, single MOSFET driver.
LTC4282	High current hot-swap controller with I ² C compatible monitoring	Operates from 2.9 V to 33 V, 12-bit ADC monitoring current, voltage, and power, dual MOSFET drivers.

OUTLINE DIMENSIONS

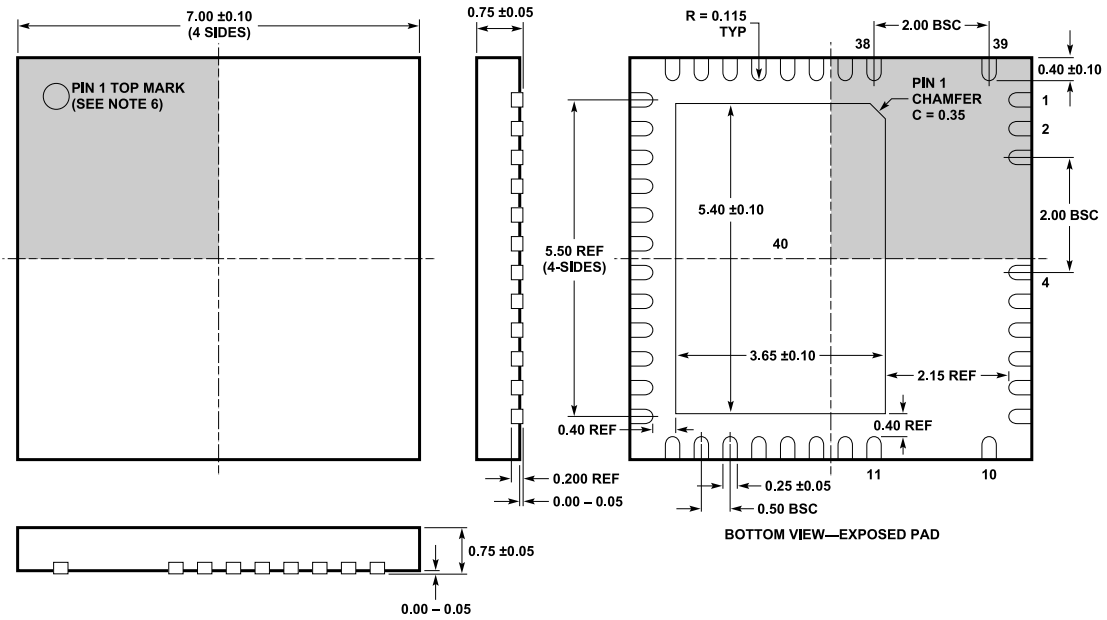

- NOTE:
1. DRAWING CONFORMS TO JEDEC PACKAGE OUTLINE MO-220 VARIATION (WKKD-2)
 2. DRAWING NOT TO SCALE
 3. ALL DIMENSIONS ARE IN MILLIMETERS
 4. DIMENSIONS OF EXPOSED PAD ON BOTTOM OF PACKAGE DO NOT INCLUDE MOLD FLASH. MOLD FLASH, IF PRESENT, SHALL NOT EXCEED 0.20mm ON ANY SIDE, IF PRESENT
 5. EXPOSED PAD SHALL BE SOLDER PLATED
 6. SHADED AREA IS ONLY A REFERENCE FOR PIN 1 LOCATION ON THE TOP AND BOTTOM OF PACKAGE

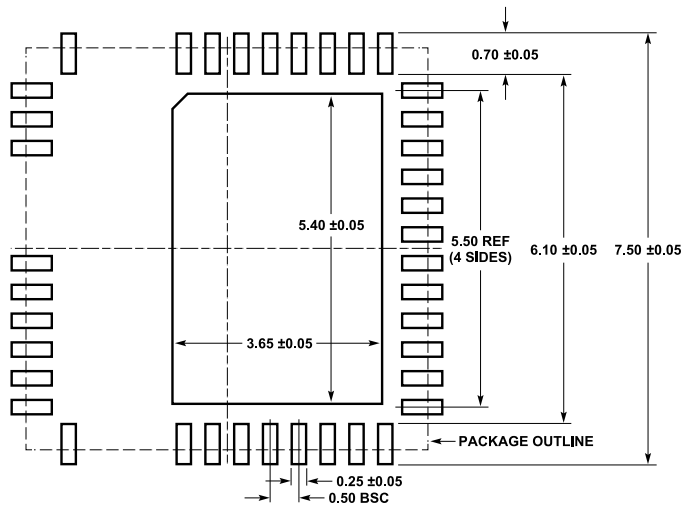

RECOMMENDED SOLDER PAD PITCH AND DIMENSIONS
APPLY SOLDER MASK TO AREAS THAT ARE NOT SOLDERED

Figure 37. 48(39)-Lead Plastic QFN (7 mm × 7 mm)
(05-08-1792)

Dimensions shown in millimeters