



## VARIABLE GAIN AMPLIFIER 5 - 12 GHz

### Typical Applications

The HMC996LP4E is ideal for:

- Point-to-Point Radio
- Point-to-Multi-Point Radio
- EW & ECM Subsystems
- X-Band Radar
- Test Equipment & Sensors

### Features

- Wide Gain Control Range: 22 dB
- Single Control Voltage: -1 to -4.5V
- Output IP3 @ Max Gain: +34 dBm
- Output P1dB: +22 dBm
- Low Noise Figure 2dB @ max gain
- No External Matching
- 24 Lead 4x4 mm SMT Package: 16 mm<sup>2</sup>

### Functional Diagram

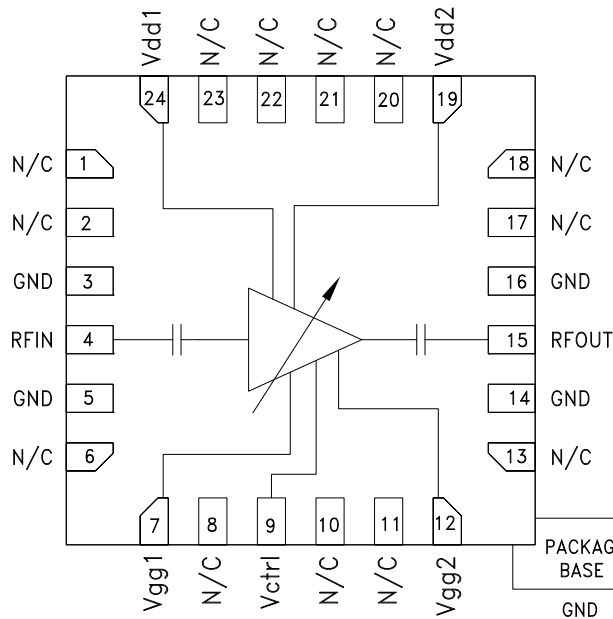

### General Description

The HMC996LP4E is a GaAs PHEMT MMIC analog variable gain amplifier and / or driver amplifier which operates between 5 and 12 GHz. Ideal for microwave radio applications, the amplifier provides up to 18.5 dB of gain, output P1dB of up to +23 dBm, and up to +34 dBm of output IP3 at maximum gain, while requiring only 170 mA from a +5V supply. Gain control voltage pin (Vctrl) is provided to allow variable gain control up to 22 dB. Gain flatness is excellent making the HMC996LP4E ideal for EW, ECM and radar applications. The HMC996LP4E is housed in a RoHS compliant 4 x 4 mm QFN leadless package and is compatible with high volume surface mount manufacturing.

### Electrical Specifications, $T_A = +25^\circ\text{C}$ , $V_{dd1, 2} = 5\text{V}$ , $V_{ctrl} = -4.5\text{V}$ , $I_{dd} = 120\text{ mA}^*$

Parameter	Min.	Typ.	Max.	Min.	Typ.	Max.	Units
Frequency Range		5 - 8.5		8.5 - 12			GHz
Gain	16	18.5		13	16		dB
Gain Flatness		$\pm 0.5$			$\pm 1$		dB
Gain Variation Over Temperature		0.006			0.006		dB/ °C
Gain Control Range	15	22		15	20		dB
Noise Figure		2.5			2		dB
Input Return Loss		17			9		dB
Output Return Loss		23			7		dB
Output Power for 1 dB Compression (P1dB)	19	22		20	23		dBm
Saturated Output Power (Psat)		23			24		dBm
Output Third Order Intercept (IP3)		34			34		dBm
Total Supply Current (Idd)		120			120		mA

\*Set Vctrl = -4.5V and then adjust Vgg1, 2 between -2V to 0V to achieve Idd = 120 mA typical.



**VARIABLE GAIN AMPLIFIER  
5 - 12 GHz**

**Gain vs. Control Voltage Range**

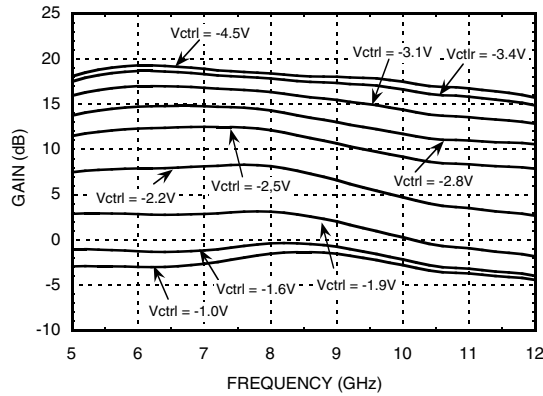

**Gain vs. Control Voltage**

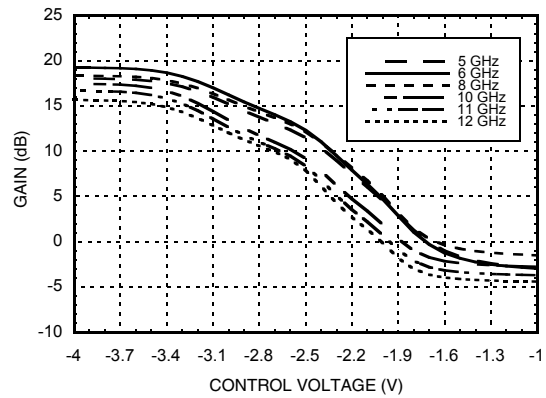

**Broadband Gain & Return Loss**

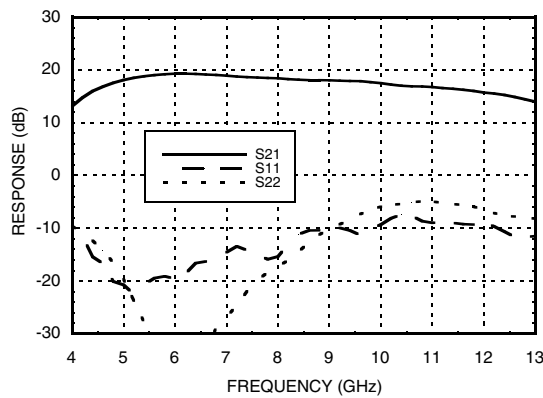

**Gain vs. Temperature**

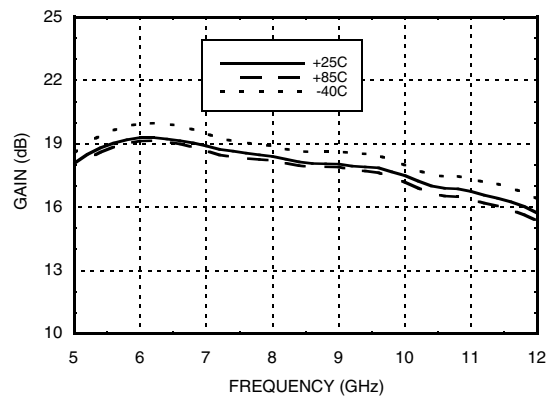

**Input Return Loss vs. Temperature**

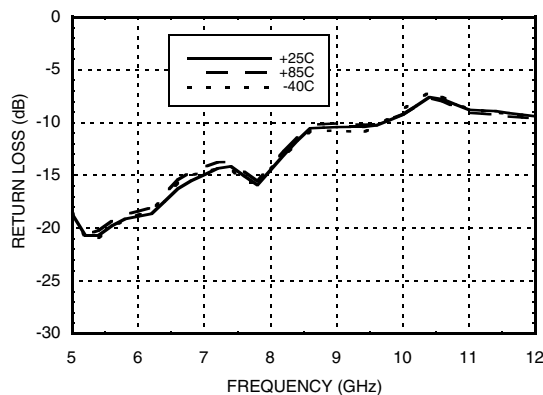

**Output Return Loss vs. Temperature**

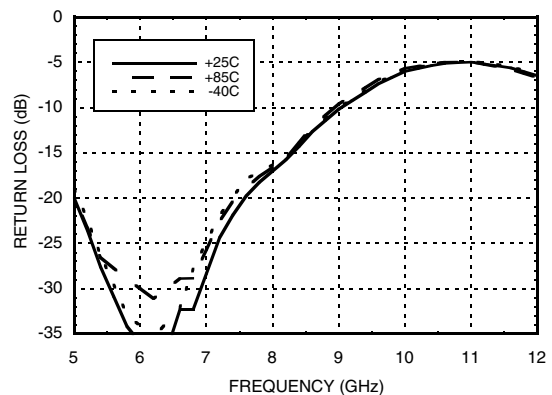



**VARIABLE GAIN AMPLIFIER  
5 - 12 GHz**

VARIABLE GAIN AMPLIFIER - SMT

**Input Return Loss @ Control Voltage Extreme**

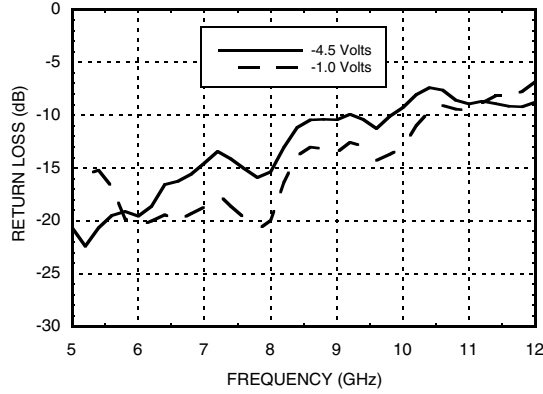

**Output Return Loss @ Control Voltage Extreme**

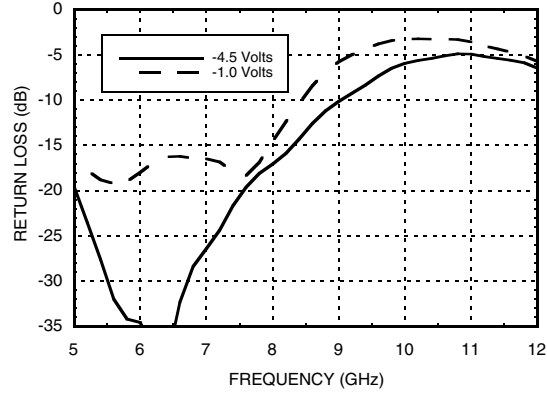

**Noise Figure vs. Temperature**

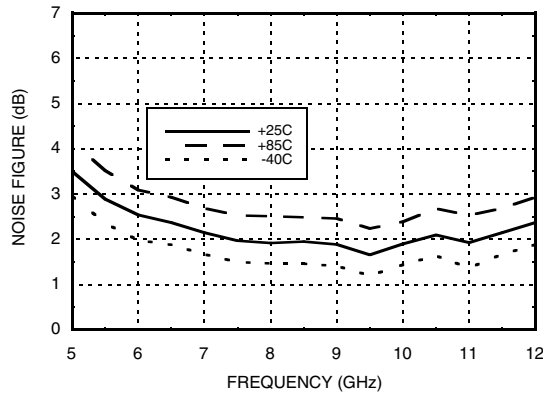

**Noise Figure vs. Control Voltage**

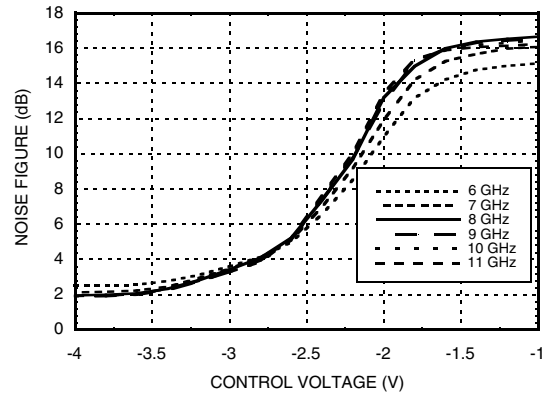

**P1dB vs. Temperature**

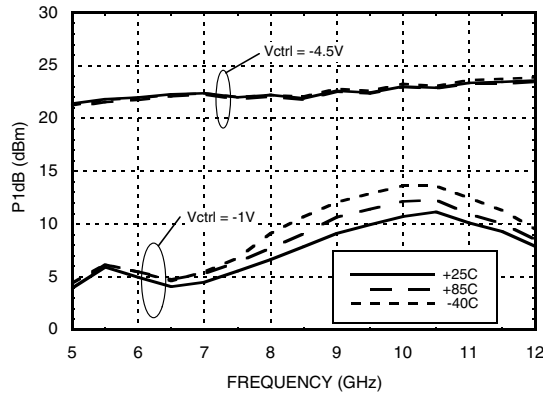

**Psat vs. Temperature**

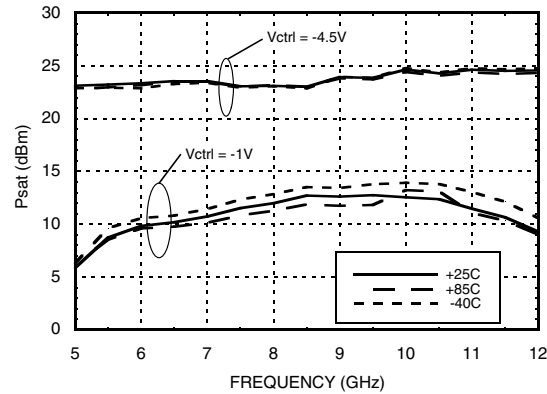

Information furnished by Analog Devices is believed to be accurate and reliable. However, no responsibility is assumed by Analog Devices for its use, nor for any infringements of patents or other rights of third parties that may result from its use. Specifications subject to change without notice. No license is granted by implication or otherwise under any patent or patent rights of Analog Devices. Trademarks and registered trademarks are the property of their respective owners.

For price, delivery, and to place orders: Analog Devices, Inc., One Technology Way, P.O. Box 9106, Norwood, MA 02062-9106 Phone: 781-329-4700 • Order online at [www.analog.com](http://www.analog.com) Application Support: Phone: 1-800-ANALOG-D



**VARIABLE GAIN AMPLIFIER  
5 - 12 GHz**

**Reverse Isolation vs. Temperature**

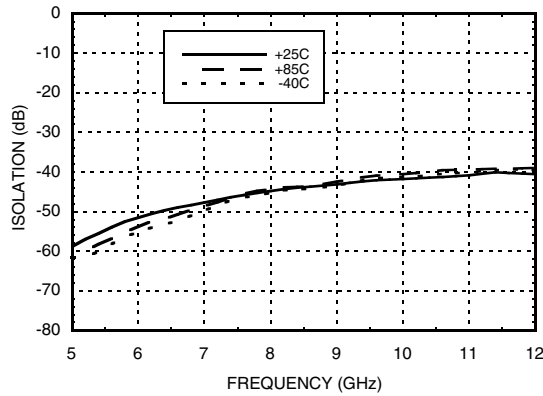

**Output IP3 vs. Temperature**

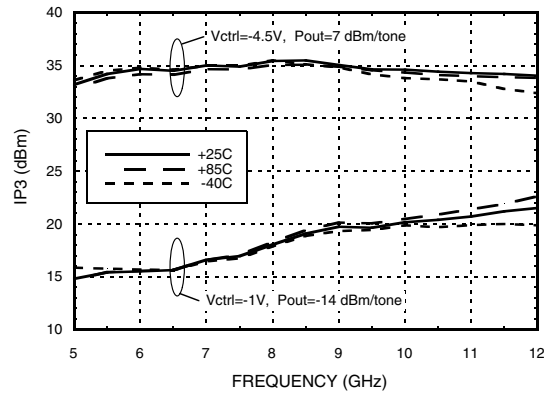

**IP3 and Gain @ 6 GHz, Pin = -10 dBm**

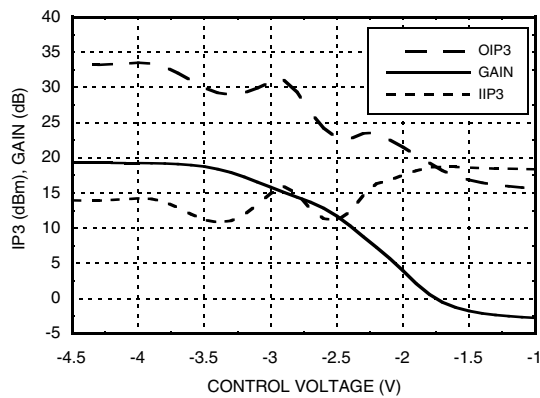

**IP3 and Gain @ 8 GHz, Pin = -10 dBm**

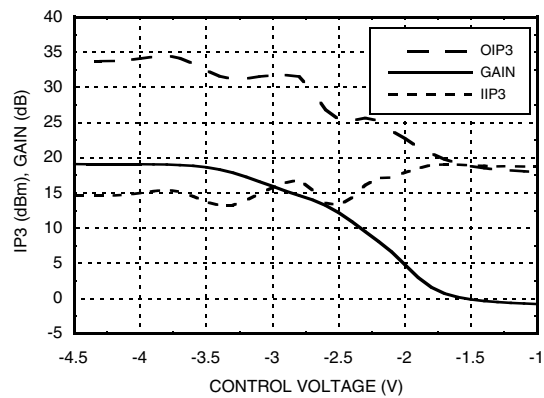

**IP3 and Gain @ 10 GHz, Pin = -10 dBm**

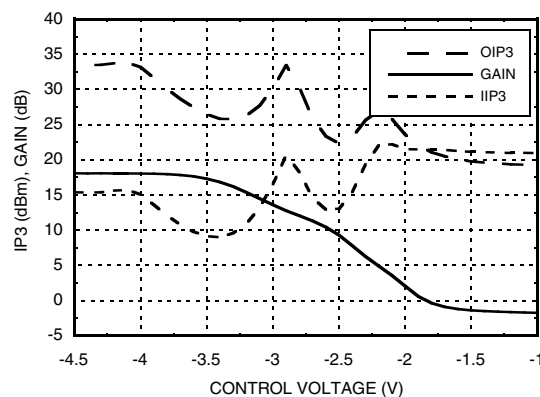

## VARIABLE GAIN AMPLIFIER 5 - 12 GHz



### Absolute Maximum Ratings

Drain Bias Voltage (Vdd1, 2)	+5.5V
Gate Bias Voltage (Vgg1, 2)	-3 to 0V
Gain Control Voltage (Vctrl)	-5 to 0V
RF Power Input	+20 dBm
Channel Temperature	175 °C
Continuous Pdiss (T = 85 °C) (derate 11.5 mW/°C above 85 °C) [1]	1.03 W
Thermal Resistance (Channel to ground paddle)	86.7 °C/W
Storage Temperature	-65 to +150 °C
Operating Temperature	-40 to +85 °C
ESD Sensitivity (HBM)	Class 0 Passed 150V

### Bias Voltage

Vdd1,2(V)	Idd Total (mA)
+5V	120 mA
Vgg1,2 (V)	Igg Total (mA)
0V to -2V	<0.1 mA



**ELECTROSTATIC SENSITIVE DEVICE  
OBSERVE HANDLING PRECAUTIONS**

### Outline Drawing

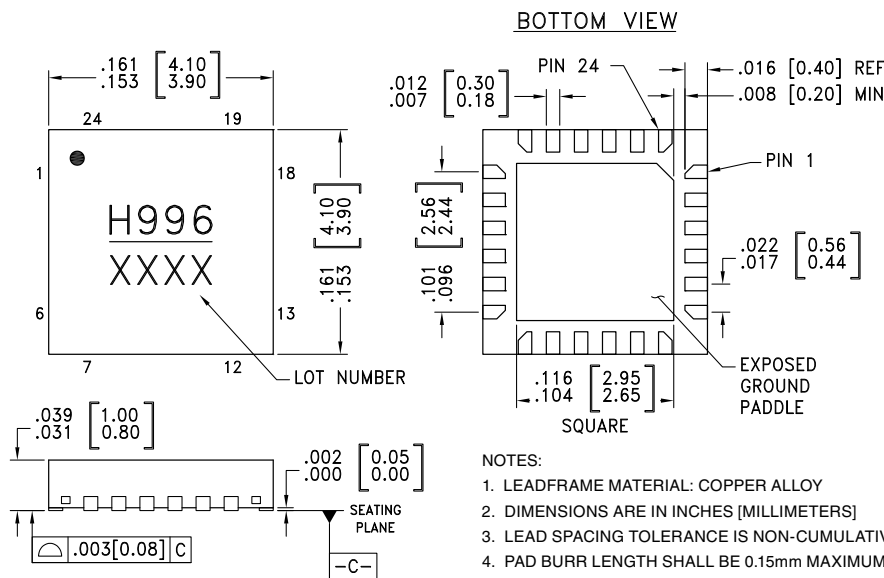

**NOTES:**

- LEADFRAME MATERIAL: COPPER ALLOY
- DIMENSIONS ARE IN INCHES [MILLIMETERS]
- LEAD SPACING TOLERANCE IS NON-CUMULATIVE.
- PAD BURR LENGTH SHALL BE 0.15mm MAXIMUM.  
PAD BURR HEIGHT SHALL BE 0.05mm MAXIMUM.
- PACKAGE WARP SHALL NOT EXCEED 0.05mm.
- ALL GROUND LEADS AND GROUND PADDLE MUST BE SOLDERED TO PCB RF GROUND.
- REFER TO HITTITE APPLICATION NOTE FOR SUGGESTED LAND PATTERN.

### Package Information

Part Number	Package Body Material	Lead Finish	MSL Rating	Package Marking [2]
HMC996LP4E	RoHS-compliant Low Stress Injection Molded Plastic	100% matte Sn	MSL1 [1]	H996 XXXX

[1] Max peak reflow temperature of 260 °C

[2] 4-Digit lot number XXXX

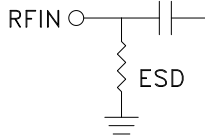
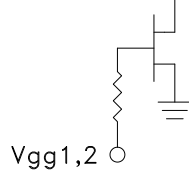
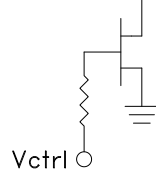
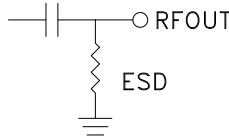
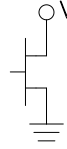

### Pin Descriptions

Pin Number	Function	Description	Interface Schematic
1, 2, 6, 8, 10, 11, 13, 17, 18, 20, 21, 22, 23	N/C	The pins are not connected internally; however all data shown herein was measured with these pins connected to RF/DC ground externally	
3, 5, 14, 16	GND	These pins and exposed ground paddle must be connected to RF/DC ground.	
4	RFIN	This pad is AC coupled and matched to 50 Ohm.	
7, 12	Vgg1, 2	Gate control for amplifier. Adjust voltage to achieve typical I <sub>dd</sub> . Please follow "MMIC Amplifier Biasing Procedure" application note.	
9	Vctrl	Gain control Voltage for the amplifier. See assembly diagram for required external components.	
15	RFOUT	This pad is AC coupled and matched to 50 Ohm.	
19, 24	Vdd1, 2	Drain Bias Voltage for the amplifier. See assembly diagram for required external components	



**VARIABLE GAIN AMPLIFIER  
5 - 12 GHz**

**Application Circuit**

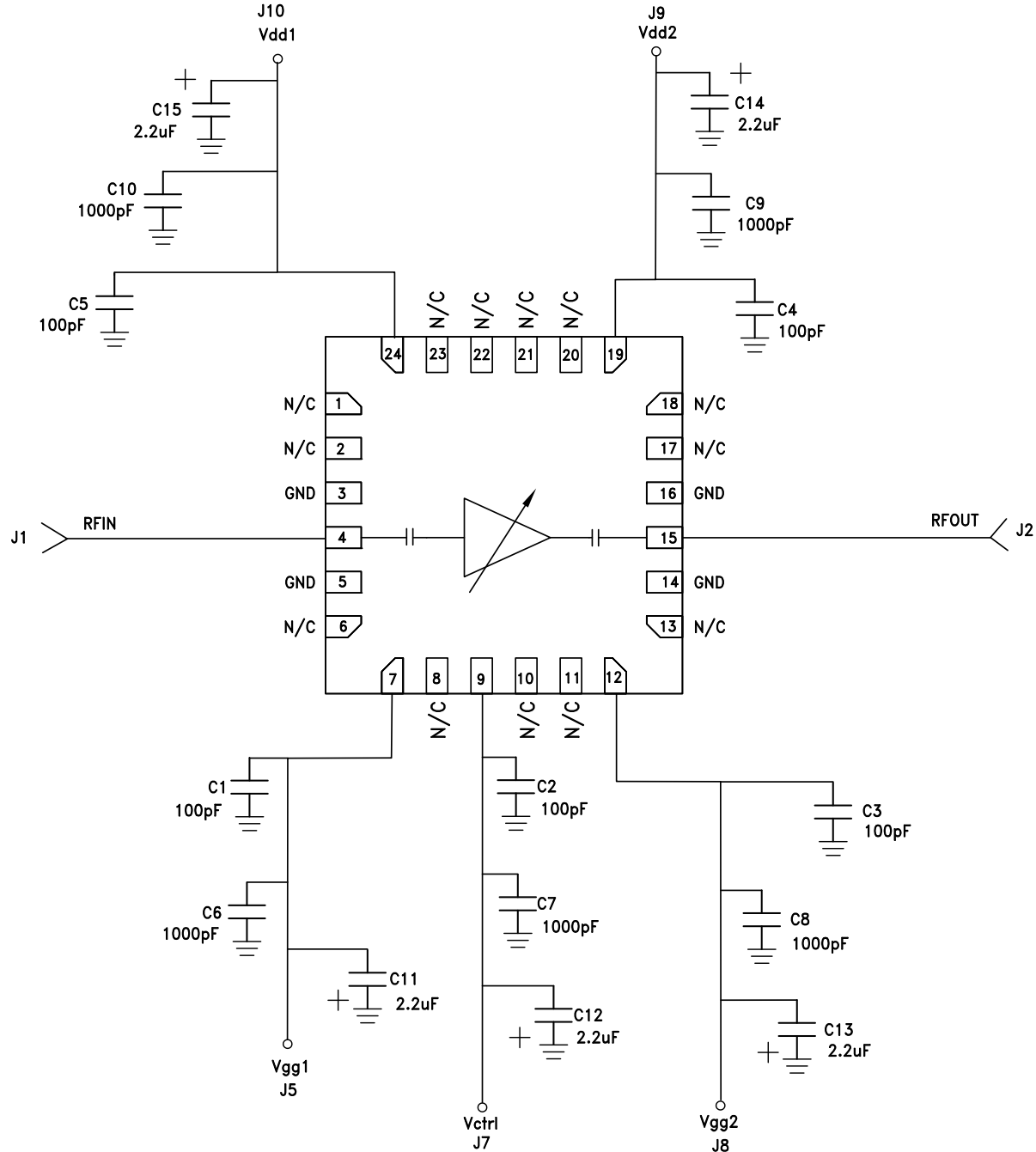

Information furnished by Analog Devices is believed to be accurate and reliable. However, no responsibility is assumed by Analog Devices for its use, nor for any infringements of patents or other rights of third parties that may result from its use. Specifications subject to change without notice. No license is granted by implication or otherwise under any patent or patent rights of Analog Devices. Trademarks and registered trademarks are the property of their respective owners.

For price, delivery, and to place orders: Analog Devices, Inc., One Technology Way, P.O. Box 9106, Norwood, MA 02062-9106 Phone: 781-329-4700 • Order online at [www.analog.com](http://www.analog.com) Application Support: Phone: 1-800-ANALOG-D