

### DESCRIPTION

The EVCS180X-S-Y-00A is an evaluation board designed to demonstrate the capabilities of the MCS180X family, which are linear Hall-effect current sensors for AC and DC current sensing. The Hall array is differential, which cancels out stray magnetic field. This series of parts provides two power supply options (3.3V or 5V) and six full current ranges of 5A to 50A for the best accuracy in different applications.

The output voltage ( $V_{OUT}$ ) is proportional to the primary applied current flowing through the primary conductor. The galvanic isolation between the primary conductive path pins and the sensor leads allow the MCS180X to take the place of optoisolators or other expensive isolation devices. The MCS180X is available in an SOIC-8 package.

### ELECTRICAL SPECIFICATIONS

| Parameter                       | Symbol       | Value   | Units |
|---------------------------------|--------------|---|-------|
| Supply voltage                  | $V_{CC}$     | 3.3 or 5  | V     |
| Maximum primary applied current | $I_{P\_MAX}$ | Six ranges from 5 to 50                             | A     |
| Output voltage                  | $V_{OUT}$    | $0.5 \times V_{CC} + Sens_{(TYP)} \times I_P^{(1)}$ | V     |

**Note:**

1)  $Sens_{(TYP)}$  is the symbol for "typical sensitivity."

### FEATURES

- 3.3V or 5V Supply Voltage
- 5A to 50A Primary Applied Current
- Differential Hall Array for External Magnetic Field Cancellation
- 0.9mΩ Internal Conductor Resistance
- 100kHz Maximum Bandwidth
- 4μs Minimum Output Rise Time

### APPLICATIONS

- Motor Controls
- Automotive Systems
- Load Detection and Load Management
- Switch-Mode Power Supplies
- Over-Current Fault Protections

All MPS parts are lead-free, halogen-free, and adhere to the RoHS directive. For MPS green status, please visit the MPS website under Quality Assurance. "MPS", the MPS logo, and "Simple, Easy Solutions" are trademarks of Monolithic Power Systems, Inc. or its subsidiaries.

## EVCS180X-S-Y-00A EVALUATION BOARD

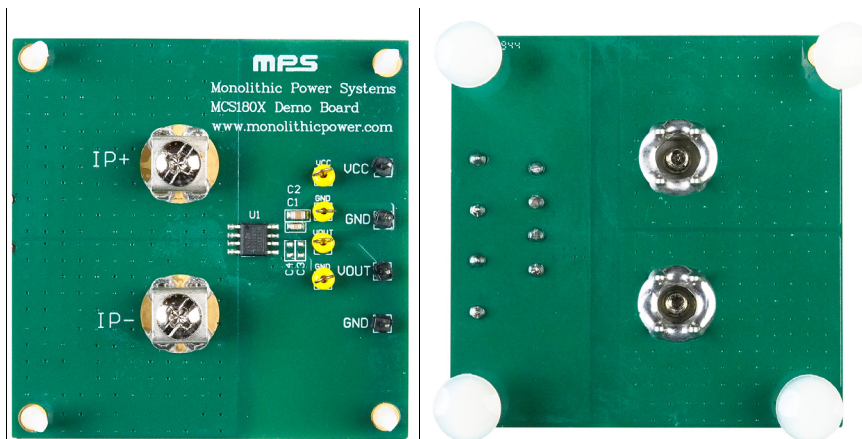

LxWxH (58mmx58.5mmx12mm)

| Board Number     | MPS IC Number |
|------------------|---------------|
| EVCS180X-S-Y-00A | MCS180XGS-Y   |

**EVALUATION BOARD BASIC INFORMATION**

| Evaluation Board PN | Typical VCC Supply Voltage (V) | Optimized Primary Current (A) | Typical Sensitivity (mV/A) |
|---------------------|--------------------------------|-------------------------------|----------------------------|
| EVCS1800-S-12-00A   | 3.3                            | ±12.5                         | 110                        |
| EVCS1800-S-25-00A   |                                | ±25                           | 55                         |
| EVCS1801-S-12-00A   | 5                              | ±12.5                         | 160                        |
| EVCS1801-S-25-00A   |                                | ±25                           | 80                         |
| EVCS1802-S-05-00A   | 3.3                            | ±5                            | 264                        |
| EVCS1802-S-10-00A   |                                | ±10                           | 132                        |
| EVCS1802-S-20-00A   |                                | ±20                           | 66                         |
| EVCS1802-S-30-00A   |                                | ±30                           | 44                         |
| EVCS1802-S-40-00A   |                                | ±40                           | 33                         |
| EVCS1802-S-50-00A   |                                | ±50                           | 26.4                       |
| EVCS1803-S-05-00A   |                                | 5                             | ±5                         |
| EVCS1803-S-10-00A   | ±10                            |                               | 200                        |
| EVCS1803-S-20-00A   | ±20                            |                               | 100                        |
| EVCS1803-S-30-00A   | ±30                            |                               | 66                         |
| EVCS1803-S-40-00A   | ±40                            |                               | 50                         |
| EVCS1803-S-50-00A   | ±50                            |                               | 40                         |

## QUICK START GUIDE

1. Preset the DC power supply to 3.3V or 5V.
2. Turn off the power supply.
3. Connect the DC power supply terminals to:
  - a. Positive (+): VCC
  - b. Negative (-): GND
4. Connect the current source load terminals to:
  - a. Positive (+): IP+
  - b. Negative (-): IP-
5. Turn on the DC power supply and current source. Measure the output result via the VOUT pin.
6. C4 determines the sensor's bandwidth. A larger C4 capacitance leads to a lower sensor bandwidth.

**EVALUATION BOARD SCHEMATIC**

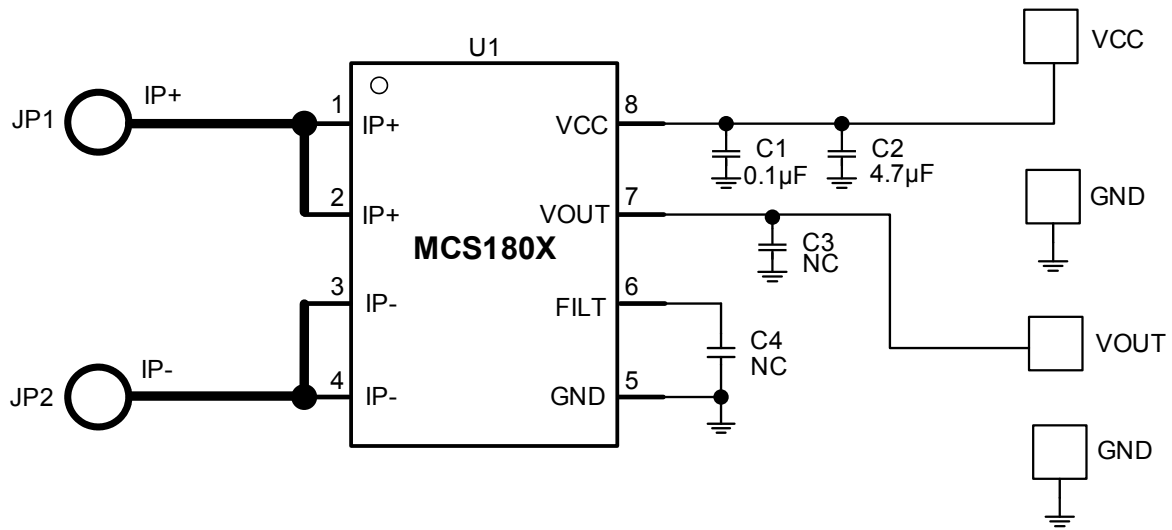

**Figure 1: Evaluation Board Schematic**

**EVCS180X-S-Y-00A BILL OF MATERIALS**

| Qty | Ref        | Value        | Description                                | Package | Manufacturer         | Manufacturer PN    |
|-----|------------|--------------|--|---------|----------------------|--------------------|
| 1   | C1         | 0.1 $\mu$ F  | VCC ceramic decoupling capacitor, 16V, X7R | 0603    | Murata               | GRM188R71C104KA01D |
| 1   | C2         | 4.7 $\mu$ F  | VCC ceramic decoupling capacitor, 16V, X7R | 0805    | Murata               | GCM21BR71C475KA73L |
| 1   | C3         | NS           | Optional filter cap                        |         |                      |                    |
| 1   | C4         | NS           | Optional filter cap                        |         |                      |                    |
| 4   | Pin header | 2.54mm       | Male pin header                            | DIP     | BKL Electronic       | 10120920           |
| 2   | IP+, IP-   | 6.32 Philips | 4-pin screw terminal                       | DIP     | Keystone Electronics | 8191K-ND           |
| 1   | U1         | MCS180X      | Current sensor                             | SOIC-8  | MPS                  | MCS180XGS-Y        |

## EVB TEST RESULTS

Performance waveforms are tested on the EVCS1803-S-50-00A evaluation board.  $V_{CC} = 5V$ , C3 is open, C4 is open,  $T_A = 25^\circ C$ , unless otherwise noted.

**DC Current Status**

$I_P = 50A$

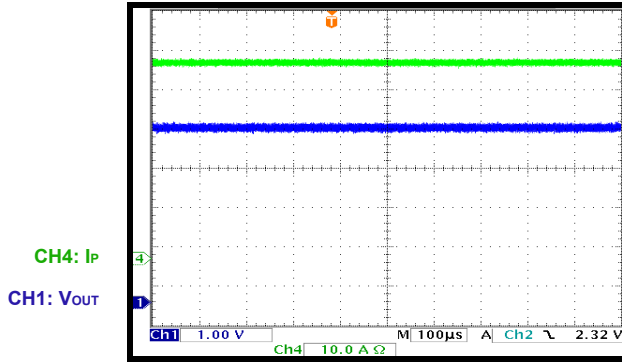

**DC Current Status**

$I_P = -50A$

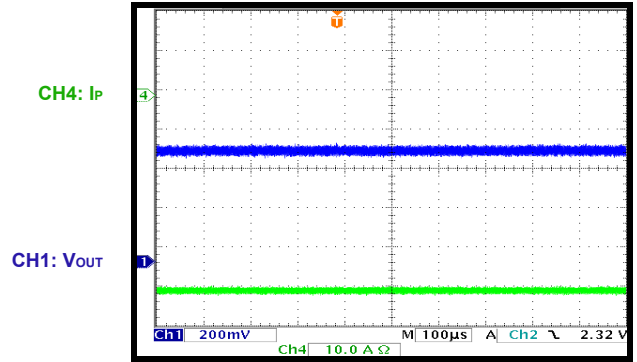

**Start-Up through VCC**

$I_P = 50A$

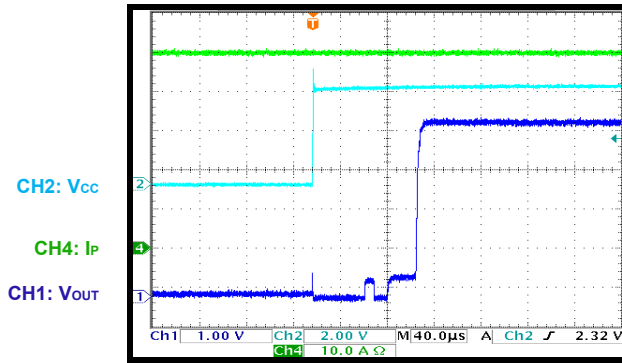

**Shutdown through VCC**

$I_P = 50A$

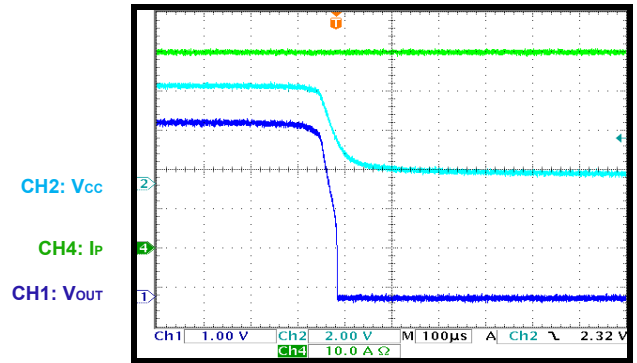

**Step-Up Current**

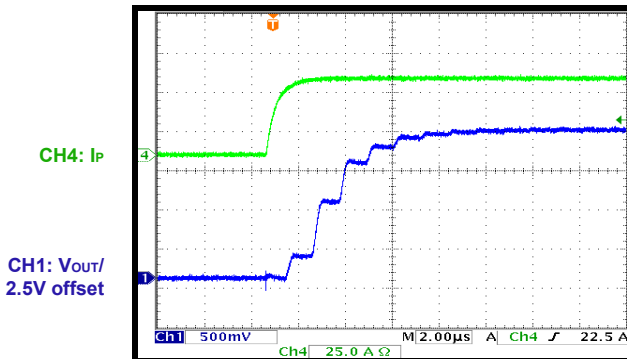

**Step-Down Current**

$I_P = 50A$

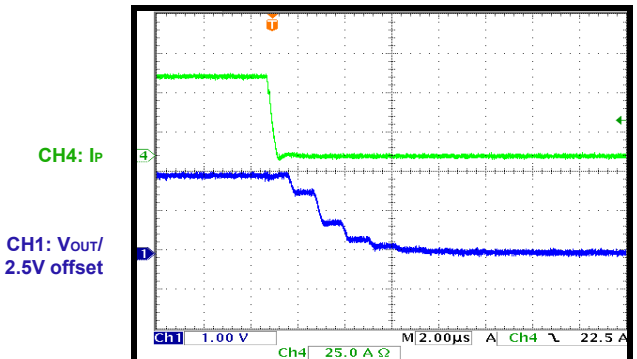

**PCB LAYOUT**

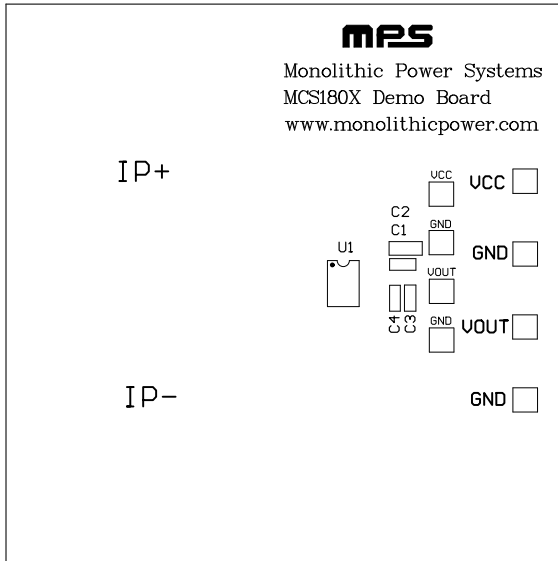

**Figure 2: Top Silk**

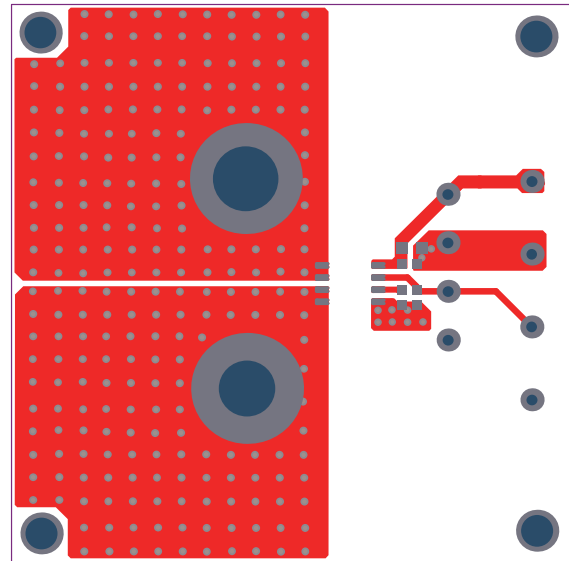

**Figure 3: Top Layer**

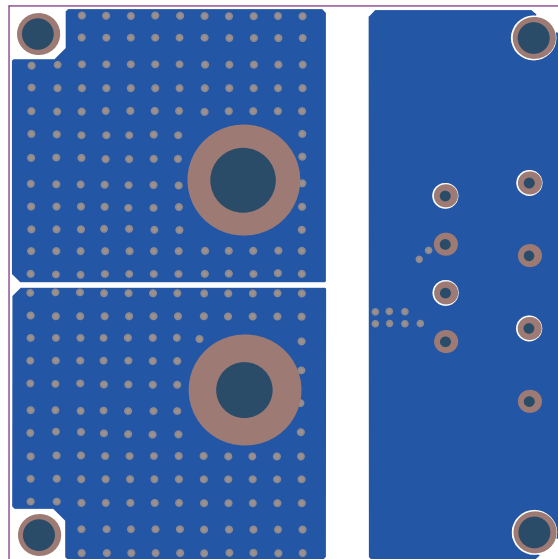

**Figure 4: Bottom Layer**