



EVK-N3

SARA-N3 series cellular evaluation kits

User guide



Abstract

This guide explains how to set up the EVK-N3 evaluation kits to begin evaluating the u-blox SARA-N3 series cellular modules supporting LTE Cat NB2 radio access technology.

Document information

Title	EVK-N3	
Subtitle	SARA-N3 series cellular evaluation kits	
Document type	User guide	
Document number	UBX-19004195	
Revision and date	R06	01-Oct-2021
Disclosure restriction	C1-Public	

Product status	Corresponding content status	
Functional sample	Draft	For functional testing. Revised and supplementary data will be published later.
In development / Prototype	Objective specification	Target values. Revised and supplementary data will be published later.
Engineering sample	Advance information	Data based on early testing. Revised and supplementary data will be published later.
Initial production	Early production information	Data from product verification. Revised and supplementary data may be published later.
Mass production / End of life	Production information	Document contains the final product specification.

This document applies to the following products:

Product name	Type number	Modem version	Application version	PCN reference	Product status
EVK-N310	EVK-N310-0-00	18.13	A01.02	UBX-21039338	Initial production

u-blox or third parties may hold intellectual property rights in the products, names, logos and designs included in this document. Copying, reproduction, modification or disclosure to third parties of this document or any part thereof is only permitted with the express written permission of u-blox.

The information contained herein is provided "as is" and u-blox assumes no liability for its use. No warranty, either express or implied, is given, including but not limited to, with respect to the accuracy, correctness, reliability and fitness for a particular purpose of the information. This document may be revised by u-blox at any time without notice. For the most recent documents, visit www.u-blox.com.

Copyright © u-blox AG.

Contents

Document information	2
Contents	3
1 Starting up	4
1.1 EVK-N3 overview	4
1.2 EVK-N3 block diagram	5
1.3 Switches, jumpers and buttons	6
1.4 LEDs.....	7
1.5 Connectors	7
1.6 EVK-N3 pin out	8
1.7 Software installation	9
1.8 Board setup	10
Appendix	12
A Setting up AT terminal applications for communication with EVK-N3	12
B AT commands examples	13
C Declaration of conformities	13
D Current consumption measurement	14
E Glossary	15
Related documentation	16
Revision history	16
Contact	17

1 Starting up

1.1 EVK-N3 overview

The EVK-N3 evaluation kits are powerful and easy-to-use tools that simplify the evaluation of u-blox SARA-N3 series Narrow Band Internet of Things (NB-IoT) modules.

The following evaluation kit is available with u-blox SARA-N3 cellular modules:

- EVK-N310 evaluation kit is for evaluation of SARA-N310

The evaluation kit EVK-N310 is herein identified as EVK-N3.

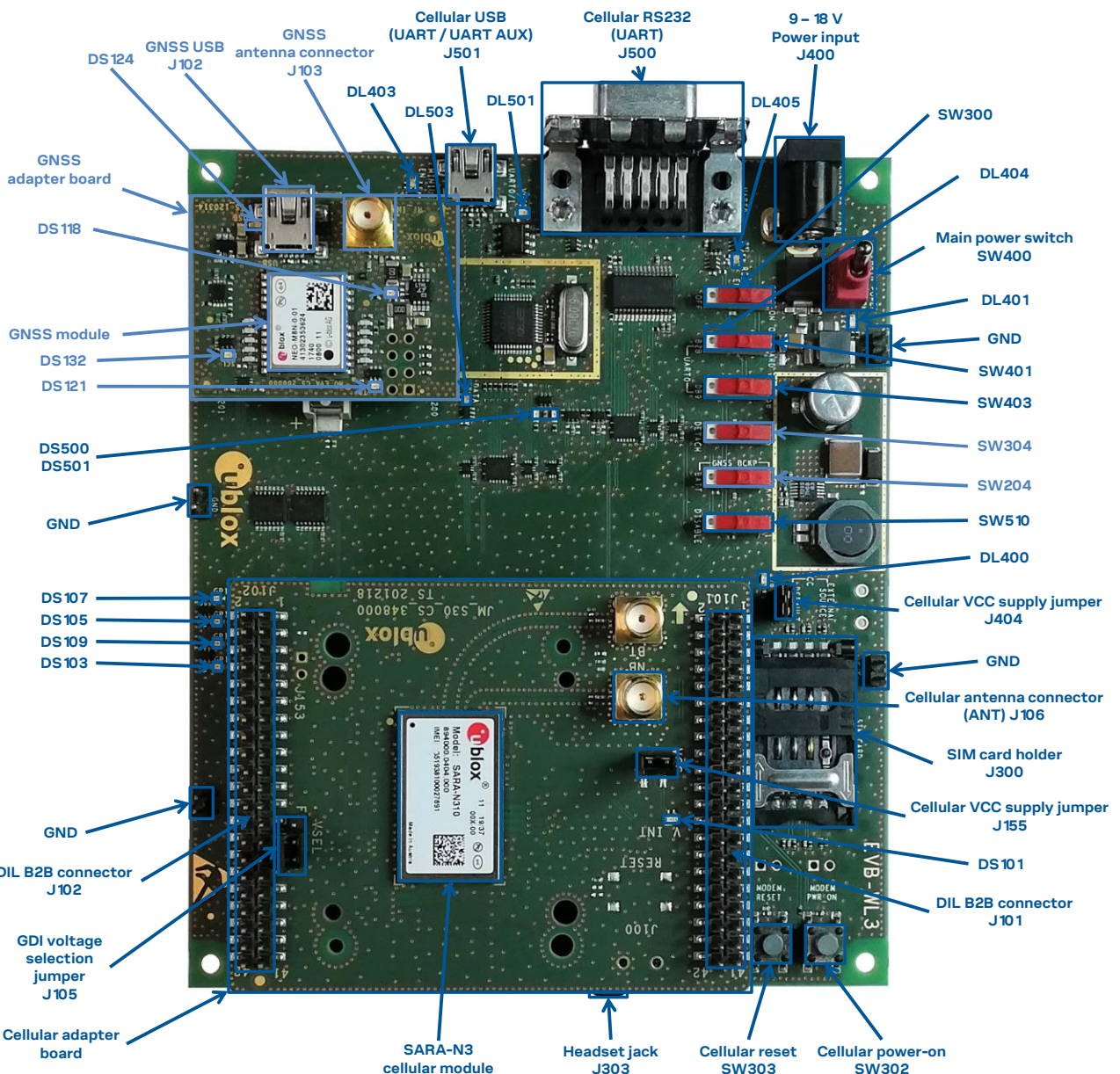

Figure 1: Overview of EVK-N3 evaluation kit for SARA-N3 modules

See the SARA-N3 series data sheet [2] and the SARA-N2/N3 series system integration manual [3] for the detailed description of the characteristics and the features supported by SARA-N3 series.

1.2 EVK-N3 block diagram

Figure 2 shows the main interfaces and internal connections of the EVK-N3 evaluation kit:

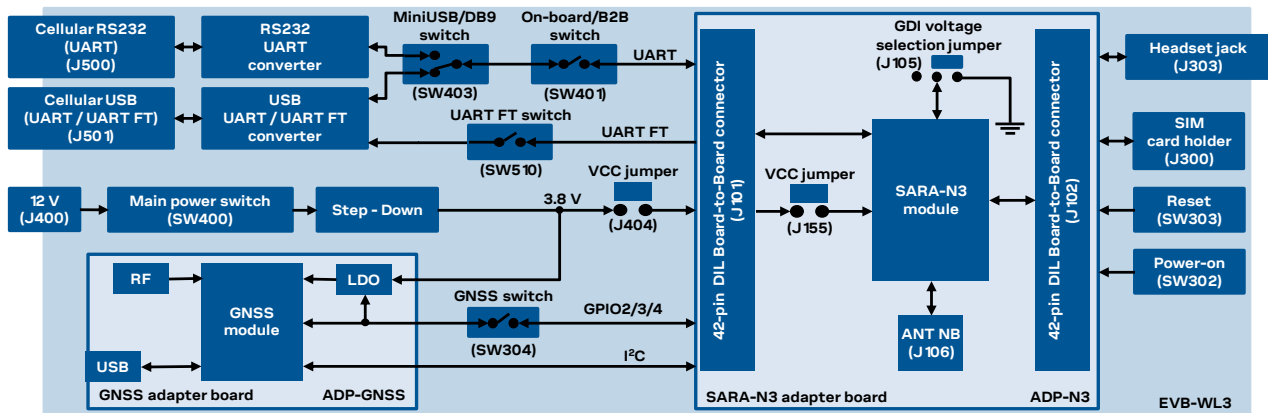

Figure 2: Block diagram of EVK-N3 for SARA-N3 series modules

The EVK-N3 evaluation kit is formed by three boards:

- The lower one, called EVB-WL3, contains the power supply and other peripherals for the SARA-N3 series cellular module (such as SIM card holder, reset button and power-on button).
- The cellular adapter board, called ADP-N3, contains the SARA-N3 cellular module, the cellular antenna connector, a 3-pin header with jumper for the digital I/O interfaces (GDI) voltage selection, a 2-pin header with jumper for VCC and current consumption measurement, and the DIL connectors (J101 and J102).
- The GNSS adapter board, called ADP-GNSS, contains the u-blox GNSS module, the GNSS antenna connector and the USB connector for the GNSS module.

The boards are connected by means of male header board-to-board connectors provided on the bottom of the adapter boards and their corresponding female connectors provided on top of the lower board.

The SARA-N3 series pins are available on the dual in-line male board-to-board connectors provided on the top layer of the cellular adapter board (J101 and J102), which are pin-to-pin compatible to the connectors on the bottom layer of the adapter board EVB-WL3.

Communication with the SARA-N3 series cellular module is provided through the Cellular RS232 DB9 connector (J500) or the Cellular USB Mini-USB connector (J501), available on the EVB-WL3 board. The UART interface of the SARA-N3 series cellular module is routed up to both the connectors - J500 and J501. The Mini-USB / DB9 slide switch (SW403) must be set according to the selected connector. The Cellular USB Mini-USB connector (J501) provides also access to the additional UART interface for firmware upgrade and tracing of the SARA-N3 series cellular module (see section 1.8).

The lower board (EVB-WL3) is designed also to be used with other u-blox cellular adapter boards. It contains additional switches, jumpers, connectors, LEDs and parts that may be partially described in Figure 1 or in this document, because they are intended for use only with other u-blox cellular modules. It is recommended to leave any additional connector unconnected and any additional switch in its default configuration.

1.3 Switches, jumpers and buttons

Function	Description	Name	Board
Main power switch	Power on / off of the whole evaluation kit	SW400	EVB-WL3
Cellular VCC jumper	Jumper socket to provide the 3.8 V supply to the cellular module VCC input	J404	EVB-WL3
		J155	ADP-N3
Cellular power-on	Push button to switch on the cellular module	SW302	EVB-WL3
Cellular reset	Push button to reset the cellular module	SW303	EVB-WL3
Cellular UART detach	Slide switch to attach / detach the cellular module UART from USB / RS232 connectors: when detached, UART signals are available only on DIL B2B connectors on ADP board	SW401	EVB-WL3
Cellular UART routing	Slide switch to select the cellular module UART routing on USB or on RS232 connector	SW403	EVB-WL3
Cellular UART FT detach	Slide switch to attach / detach the cellular module UART FT from USB connector: when detached, the UART FT signals are available only on the DIL B2B connector on ADP board	SW510	EVB-WL3
Cellular GPIO detach	Slide switch to attach / detach the cellular module GPIOs from peripherals: when detached, the signals are available only on the DIL B2B connectors on ADP board	SW300	EVB-WL3
Cellular GNSS detach	Slide switch to attach / detach the cellular module to the GNSS module (GPIO2-3-4): when detached, the signals are available only on DIL B2B connector on ADP board	SW304	EVB-WL3
GNSS V_BCKP	Slide switch to connect / disconnect backup battery to V_BCKP pin of the GNSS module	SW204	EVB-WL3
Cellular GDI voltage selection Jumper	3-pin header with jumper to select operating voltage for cellular Generic Digital I/O Interfaces: 'L' = 1.8 V / 'F' = 2.8 V	J105	ADP-N3

Table 1: Description of EVK-N3 switch, jumpers and buttons

1.4 LEDs



















Function	Description	LED #	Board	Color
Main Power	Power supply plugged in the 9 - 18 V Power Input	DL401	EVB-WL3	
Cellular VCC	Cellular module supplied. Main Power Switch must be switched on	DL400	EVB-WL3	
Cellular USB (UART/UART FT)	USB cable plugged in the Cellular USB connector for UART / UART FT access	DL501	EVB-WL3	
Cellular USB / UART	Green light is activated when UART is routed to the Cellular USB connector. Red light blinks at UART TX or RX data on the Cellular USB connector	DL403	EVB-WL3	
Cellular UART detach	UART signals are available only on the DIL B2B connector on ADP board	DL404	EVB-WL3	
Cellular RS232 / UART	Green light is activated when UART is routed to Cellular RS232 connector. Red light blinks at UART TX or RX data on the Cellular RS232 connector	DL405	EVB-WL3	
Cellular USB / UART FT	Green light is activated when UART FT is routed to Cellular USB connector. Red light blinks at UART FT data on the Cellular USB connector	DL503	EVB-WL3	
Cellular RI indicator	Red light is activated when RI line turns ON (active low)	DS501	EVB-WL3	
Cellular CTS indicator	Green light is activated when CTS line turns ON (active low)	DS500	EVB-WL3	
Cellular GPIO1 indicator	Green light is activated when SARA-N3 GPIO1 is high	DS107	EVB-WL3	
Cellular GPIO2 indicator	Green light is activated when SARA-N3 GPIO2 is high	DS105	EVB-WL3	
Cellular GPIO3 indicator	Green light is activated when SARA-N3 GPIO3 is high	DS109	EVB-WL3	
Cellular GPIO4 indicator	Green light is activated when SARA-N3 GPIO4 is high	DS103	EVB-WL3	
V_INT supply	Green light is activated when the V_INT line is at a “high” level	DS101	ADP-N3	
GNSS VCC supply	GNSS module supply is turned ON	DS118	ADP-GNSS	
GNSS USB	USB cable plugged in the GNSS USB connector	DS124	ADP-GNSS	
GNSS timepulse	Pulses at 1 Hz when valid GNSS fix	DS121	ADP-GNSS	
Cellular / GNSS DDC	Cellular / GNSS module communication over the DDC (I2C) interface	DS132	ADP-GNSS	

Table 2: Description of EVK-N3 LEDs

1.5 Connectors

Function	Description	Name	Board
9 - 18 V Power Input	Connector for the AC / DC power adapter of the EVK  IEC 60417-5172 Class II equipment AC: 100-240 V, 0.8 A, 50-60 Hz / DC: +12 V, 2.5 A	J400	EVB-WL3
SIM card holder	SIM card holder	J300	EVB-WL3
Cellular antenna	SMA connector for the module cellular antenna ANT NB	J106	ADP-N3
Cellular USB (UART/UART FT)	Mini USB connector for the cellular module UART and UART FT interfaces converted as USB interface	J501	EVB-WL3
Cellular RS232 (UART)	DB9 connector for the cellular module primary UART interface converted as RS232 interface	J500	EVB-WL3
DIL B2B headers	Dual in-line board-to-board connectors for the cellular module interfaces	J101, J102	ADP-N3
Cellular headset	Audio headset jack connector (not supported by SARA-N3 series)	J303	EVB-WL3
GNSS antenna	SMA connector for the GNSS module antenna (GNSS Antenna)	J103	ADP-GNSS
GNSS USB	Mini USB connector for the GNSS module USB interface	J102	ADP-GNSS
GNSS backup battery	Backup battery socket for the GNSS module (under GNSS adapter board)	BT200	EVB-WL3
GND	Ground terminals for the probe reference	J402, J403 J405, J406	EVB-WL3

Table 3: Description of EVK-N3 connectors

- ⚠** Caution! In the unlikely event of a failure in the internal protection circuitry there is a risk of an explosion when charging a fully or partially discharged battery. Replace the battery when it no longer has a sufficient charge for unit operation. Control the battery before use if the device has not been used for an extended period of time.
- ⚠** Caution! Risk of explosion if battery is replaced with an incorrect type. Dispose of used batteries according to the instructions!

1.6 EVK-N3 pin out

SARA-N3 module		DIL B2B connector		SARA-N3 module		DIL B2B connector	
Pin N°	Signal name	Name / Pin N°	Pin N°	Signal name	Name / Pin N°	Pin N°	Signal name
1	GND	J102 pins 7-10	33	ADC1	J102 pin 28		
2	V_BCKP	J102 pin 3	34	RSVD	Not present		
3	GND	J102 pins 7-10	35	RSVD	Not present		
4	V_INT	J102 pin 36	36	RSVD	Not present		
5	GND	J102 pins 7-10	37	RSVD	Not present		
6	DSR	J102 pin 18	38	SIM_CLK	J101 pin 15		
7	RI	J102 pin 17	39	SIM_IO	J101 pin 14		
8	DCD	J102 pin 11	40	SIM_RST	J101 pin 16		
9	DTR	J102 pin 12	41	VSIM	J101 pin 13		
10	RTS	J102 pin 13	42	GPIO5	J102 pin 23		
11	CTS	J102 pin 14	43	GND	J102 pins 7-10		
12	TXD	J102 pin 15	44	RSVD	Not present		
13	RXD	J102 pin 16	45	RSVD	J101 pins 37-41		
14	GND	J102 pins 7-10	46	RSVD	J101 pins 37-41		
15	PWR_ON	J102 pin 29	47	RSVD	J101 pins 37-41		
16	GPIO1	J102 pin 33	48	RSVD	J101 pins 37-41		
17	TXD_AUX	J102 pin 26	49	RSVD	J101 pins 37-41		
18	RESET_N	J101 pin 26	50	GND	J102 pins 7-10		
19	RXD_AUX	J102 pin 27	51	VCC	J101 pins 7-10		
20	GND	J102 pins 7-10	52	VCC	J101 pins 7-10		
21	VSEL	J102 pin 24	53	VCC	J101 pins 7-10		
22	GND	J102 pins 7-10	54	GND	J102 pins 7-10		
23	GPIO2	J102 pin 31	55	GND	J102 pins 7-10		
24	GPIO3	J102 pin 32	56	ANT	Not present		
25	GPIO4	J102 pin 25	57	GND	J102 pins 7-10		
26	SDA	J101 pin 21	58	GND	J102 pins 7-10		
27	SCL	J101 pin 20	59	ANT_BT	Not present		
28	RXD_FT	J102 pin 20	60	GND	J102 pins 7-10		
29	TXD_FT	J102 pin 19	61	GND	J102 pins 7-10		
30	GND	J102 pins 7-10	62	ANT_DET	Not present		
31	RSVD	Not present	63	GND	J102 pins 7-10		
32	GND	J102 pins 7-10	64	GND	J102 pins 7-10		

Table 4: Interfaces of the SARA-N3 series module, as routed on the 42-pin dual in-line board-to-board connectors (J101, J102) available on the ADP-N3 adapter board of the EVK-N3 evaluation kit

Dual in-line board-to-board connector J102				Dual in-line board-to-board connector J101			
Signal name	Pin N°	Pin N°	Signal name	Signal name	Pin N°	Pin N°	Signal name
Not connected	2	1	GND	Not connected	2	1	GND
Not connected	4	3	V_BCKP	Not connected	4	3	Not connected
Not connected	6	5	Not connected	Not connected	6	5	Not connected
GND	8	7	GND	VCC	8	7	VCC
GND	10	9	GND	VCC	10	9	VCC
DTR	12	11	DCD	Not connected	12	11	Not connected
CTS	14	13	RTS	SIM_IO	14	13	VSIM
RXD	16	15	TXD	SIM_RST	16	15	SIM_CLK
DSR	18	17	RI	Not connected	18	17	Not connected
RXD_FT	20	19	TXD_FT	SCL	20	19	Not connected
Not connected	22	21	Not connected	Not connected	22	21	SDA
VSEL	24	23	GPIO5	Not connected	24	23	Not connected
TXD_AUX	26	25	GPIO4	RESET_N	26	25	Not connected
ADC1	28	27	RXD_AUX	Not connected	28	27	Not connected
Not connected	30	29	PWR_ON	Not connected	30	29	Not connected
GPIO3	32	31	GPIO2	Not connected	32	31	Not connected
Not connected	34	33	GPIO1	Not connected	34	33	Not connected
V_INT	36	35	Not connected	Not connected	36	35	Not connected
Not connected	38	37	Not connected	RSVD	38	37	RSVD
Not connected	40	39	Not connected	RSVD	40	39	RSVD
GND	42	41	Not connected	GND	42	41	RSVD

Table 5: Pin-out of the 42-pin dual in-line board-to-board connectors (J101 and J102) available on the ADP-N3 adapter board of the EVK-N3 evaluation kit

 The pins / interfaces that are not supported by a specific SARA-N3 series product version should be not driven by an external device; see the SARA-N3 series data sheet [2] for the list of features supported by each SARA-N3 series product version.

1.7 Software installation

The USB drivers are available with the EVK-N3 evaluation kit package. Executable files can be downloaded from www.u-blox.com/evk-downloads and saved to any location on the computer hard drive. The installation can be started by running the executable file on a computer with the Windows operating system.

1.8 Board setup

1. Insert a SIM card into the **SIM card holder** (J300 on the EVB).
2. Connect a cellular antenna (provided with the evaluation kit) to the **Cellular antenna** SMA connector on the ADP-N3 (ANT NB, RF input/output for transmission and reception of NB-IoT RF signals)
3. If the GNSS functionality is required, connect the GNSS antenna provided with the evaluation kit to the **GNSS antenna** SMA connector on the ADP-GNSS. Place the GNSS antenna in a location with a good view of the sky.



Interface to the GNSS module is not supported by SARA-N3 series modules.

4. Connect the AC / DC +12 V power adapter provided with the evaluation kit to **9 – 18 V Power Input** connector (J400 on the EVB) LED DL401 lights blue.
5. Be sure to provide a jumper socket on both the **Cellular VCC supply jumpers** (J404 on the EVB, and J155 on the ADP-N3). These jumpers provide the connection from the 3.8 V output of the supply circuit on the EVB board to the VCC input of the module.
6. To enable the board power supply, turn the **Main power switch** (SW400 on the EVB) to the ON position. LED DL400 lights green.
7. To switch on the cellular module, press the **Cellular power-on** button (SW302 on EVB).
8. For communication via UART interface of the cellular module, the following connections are allowed and can be alternatively enabled in a mutually exclusive way (see [Table 6](#) for slide switches positions and LED status):
 - 8.1. Connect a USB cable to mini USB connector (**Cellular USB**, J501 on EVB), LED DL501 lights blue.
 In this case, two COM ports are enabled with Windows (the numbering of the COM ports can be seen via the Windows Device Manager):
 - SARA-N3 UART interface is available over the first COM port (for AT commands and data)
 - SARA-N3 additional UART FT interface is available over the second COM port (for FW update and diagnostic)
 - 8.2. Connect an RS232 cable to DB9 connector (**Cellular RS232**, J500 on EVB)

Type of connections	SW401	SW403	LED
Access to cellular UART over the Cellular USB (UART / UART FT) mini USB connector (J501)	ON-BOARD	MINIUSB	DL403
Access to cellular UART over the Cellular RS232 (UART) DB9 connector (J500)	ON-BOARD	DB9	DL405
Access to cellular UART on DIL Board-to-Board connector on the adapter board: cellular UART detached from USB (UART / UART FT) and RS232 (UART) connectors	B2B	Do not care	DL404

Table 6: Serial interface configuration

Then, besides the specific serial connector used (case [8.1](#) or case [8.2](#)), run an AT terminal application (as for example, the u-blox m-center tool) by selecting the appropriate AT COM port with these settings:

- Data rate: 57'600 bit/s
- Data bits: 8
- Parity: N
- Stop bits: 1
- Flow control: disabled

9. It is possible to access SARA-N3 module's additional UART FT for diagnostic purpose. To do so: Connect a USB cable to the mini USB connector (**Cellular USB**, J501 on EVB). LED DL501 lights blue.

In this case, two COM ports are enabled with Windows (the numbering of the COM ports can be seen via the Windows Device Manager):

- SARA-N3 series UART interface is available over the first COM port (for AT commands and data)
- SARA-N3 series additional UART FT interface is available over the second COM port (for FW update and diagnostic)

Make sure to appropriately set the related slide switches:

- SW401 set to ON-BOARD
- SW403 set to MINIUSB
- SW510 set to UART1

Then, run a terminal application (as for example the u-blox m-center tool), selecting the appropriate diagnostic COM port with the following settings:

- Data rate: 921'600 bit/s
- Data bits: 8
- Parity: N
- Stop bits: 1
- Flow control: software

See [appendix A](#) for information about how to configure the u-blox m-center AT terminal for Windows.

Appendix

A Setting up AT terminal applications for communication with EVK-N3

The u-blox m-center cellular module evaluation tool is a powerful platform for evaluating, configuring and testing u-blox cellular products. m-center includes an AT commands terminal for communication with the device and can be downloaded free-of-charge from our website (<http://www.u-blox.com>).

1. Follow the board setup instructions in section 1.8 to provide all the required connections and switching on the cellular module.
2. Run the m-center tool: after the m-center start-up, the **Home** page appears.

3. On the **Home** page, set up the AT COM port with the setting values described in section 1.8.

Check the Windows Device Manager to find out which COM port is being used by EVK-N3.

4. Enable the connection to u-blox cellular module by clicking the **Connect** button.
5. Retrieve the module and network information by clicking the **Get info** button.

6. The module information is retrieved and displayed on the **Home** page.

7. Click on the **AT Terminal** button (upper right of the **Home** page). A new window opens and the AT command terminal is now ready for communication with EVK-N3.

8. The AT terminal is ready to use. For the complete list of AT commands supported by the modules and their syntax, see the SARA-N2 / SARA-N3 series AT commands manual [1].

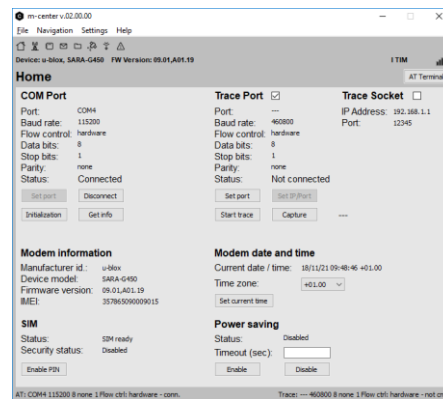

Figure 3: "Home" page

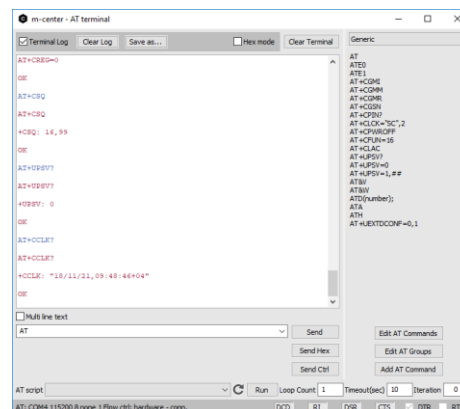

Figure 4: AT terminal window

For more information about using the u-blox m-center cellular module evaluation tool, press the F1 key on the keyboard to open the m-center help window on the computer.

B AT commands examples

For the complete description and syntax of the AT commands supported by SARA-N3 series modules, see the SARA-N2 / SARA-N3 series AT commands manual [\[1\]](#).

For detailed AT commands examples for network registration and configuration, context activation, data connection management, SIM management, module interfaces configurations and other settings, see the u-blox SARA-N3 application development guide [\[4\]](#).

C Declaration of conformities

The equipment is intended for indoor usage. It is the user's duty to verify if further restrictions apply, such as in airplanes, hospitals or hazardous locations (petrol stations, refineries...).

Any changes or modification made to this equipment will void its compliance to the safety requirements.

Maintenance, inspections and/or repairs of the EVK-N3 evaluation kits shall be performed by u-blox AG.

D Current consumption measurement

Current consumption of SARA-N3 series modules can be measured on the EVK-N3 evaluation kits by removing the jumper socket from the **Cellular VCC supply jumper J155** available on the ADP-N3 board, as shown in [Figure 5](#).

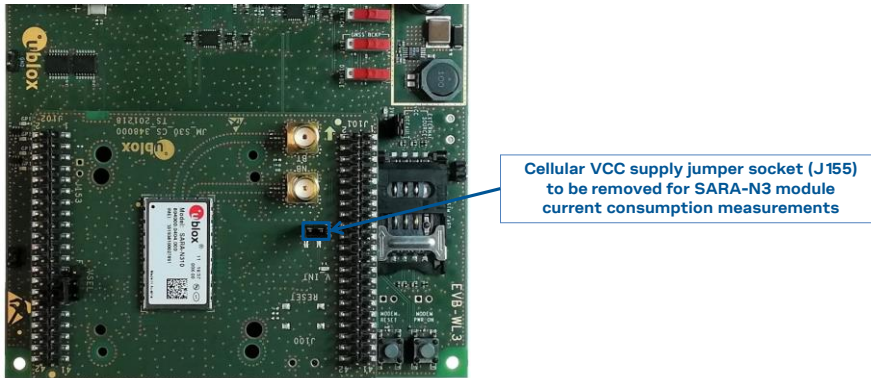

Figure 5: Jumper socket to be removed for SARA-N3 modules current consumption measurement

A suitable external digital multi-meter (as for example the Keysight/Agilent 34465A, 34410A or 34411A) can be used for current consumption measurements; in this case, the 3.8 V supply circuit on the EVB will supply the SARA-N3 module mounted on the adapter board, with the digital multi-meter placed in series as described in [Figure 6](#).

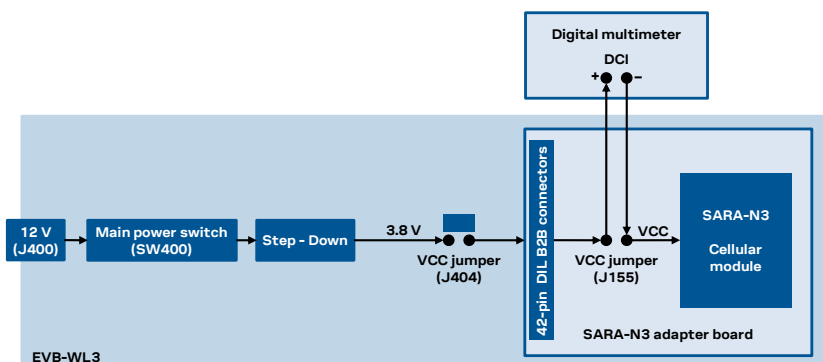

Figure 6: Block diagram of current consumption setup for SARA-N3 series modules using a digital multi-meter

Alternatively, a suitable external DC power supply with dynamic current measurement capabilities (as for example, the portable and cheap Qoitech Otii Arc, or the more accurate Keysight N6705B, or the models designed for mobile communications Keysight 66319B/D or 66321B/D) can be used for current consumption measurements, acting also as supply source for the SARA-N3 module mounted on the adapter board, as illustrated in [Figure 7](#).

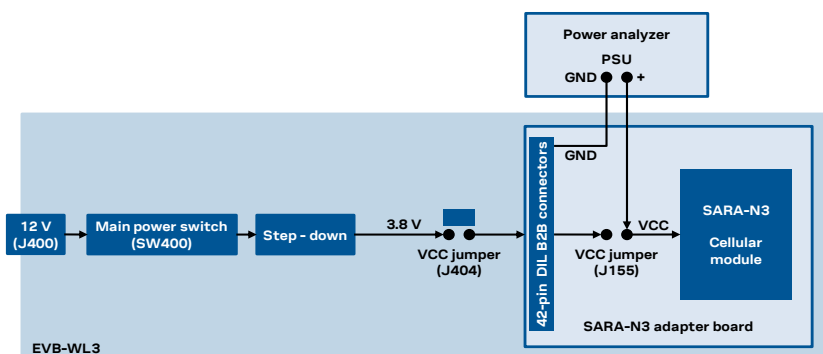

Figure 7: Block diagram of current consumption setup for SARA-N3 series modules using a DC power analyzer

E Glossary

Abbreviation	Definition
ADP	Adapter Board
AT	AT Command Interpreter Software Subsystem, or attention
B2B	Board-to-Board Connector
CTS	Clear To Send
DCI	Direct Current
DDC	Display Data Channel
DIL	Dual in-line
EVB	Evaluation Board
EVK	Evaluation Kit
FW	Firmware
GDI	Generic Digital Interface
GND	Ground
GPIO	General Purpose Input Output
I2C	Inter-Integrated Circuit
LED	Light Emitting Diode
LTE	Long Term Evolution
NB-IoT	Narrow Band Internet of Things
PSU	Power Supply Unit
RF	Radio Frequency
RI	Ring Indicator
RSVD	Reserved
RTS	Request To Send
RX	Receiver
SIM	Subscriber Identification Module
TX	Transmitter
UART	Universal Asynchronous Receiver-Transmitter
USB	Universal Serial Bus

Table 7: Explanation of the abbreviations and terms used

Related documentation

- [1] u-blox SARA-N2 / SARA-N3 series AT commands manual, [UBX-16014887](#)
- [2] u-blox SARA-N3 series data sheet, [UBX-18066692](#)
- [3] u-blox SARA-N2/N3 series system integration manual, [UBX-17005143](#)
- [4] u-blox SARA-N3 application development guide, [UBX-19026709](#)

 For regular updates to u-blox documentation and to receive product change notifications, register on our homepage (www.u-blox.com).

Revision history

Revision	Date	Name	Comments
R01	08-Mar-2019	fvid	Initial release.
R02	14-Oct-2019	lpah / fvid	Updated EVK-N300-0-00 and EVK-N310-0-00 product status; added J155 VCC jumper description for current consumption measurement
R03	29-Jun-2020	fvid	Updated product status; added reference to SARA-N3 application development guide
R04	14-Oct-2020	alos	Updated EVK-N310-0-00 product status to initial production
R05	21-May-2021	alos	Updated EVK-N310-0-00 application version and PCN reference
R06	01-Oct-2021	alos / fvid	Updated EVK-N310-0-00 application version and PCN reference. Removed document applicability to EVK-N300-0-00. Improved description for current consumption measurement.