

EVK-NINA-W1/EVK-NINA-B2

Evaluation kit for NINA-W1 and NINA-B2 modules

User guide

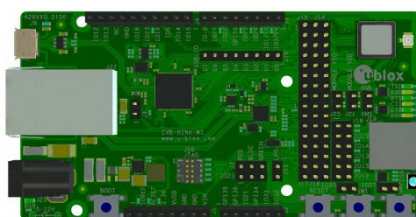

Abstract

This document describes how to set up the EVK-NINA-W1/EVK-NINA-B2 evaluation kits to evaluate NINA-W1 series and NINA-B2 series stand-alone modules. It also describes the different options for debugging and the development capabilities included in the evaluation board.

Document information

Title	EVK-NINA-W1/EVK-NINA-B2	
Subtitle	Evaluation kit for NINA-W1 and NINA-B2 modules	
Document type	User guide	
Document number	UBX-17011007	
Revision and date	R09	2-Feb-2021
Disclosure restriction	C1-Public	

This document applies to the following products:

Product name	Software version
EVK-NINA-B221	All
EVK-NINA-B222	All
EVK-NINA-W101	N/A
EVK-NINA-W102	N/A
EVK-NINA-W106	N/A
EVK-NINA-W131	All
EVK-NINA-W132	All
EVK-NINA-W151	All
EVK-NINA-W152	All
EVK-NINA-W156	All

u-blox or third parties may hold intellectual property rights in the products, names, logos and designs included in this document. Copying, reproduction, modification or disclosure to third parties of this document or any part thereof is only permitted with the express written permission of u-blox.

The information contained herein is provided "as is" and u-blox assumes no liability for its use. No warranty, either express or implied, is given, including but not limited to, with respect to the accuracy, correctness, reliability and fitness for a particular purpose of the information. This document may be revised by u-blox at any time without notice. For the most recent documents, visit www.u-blox.com.

Copyright © u-blox AG.

Contents

Document information	2
1 Product description.....	4
1.1 Overview.....	4
1.2 Kit includes	6
1.2.1 EVK-NINA-B221 and EVK-NINA-W1x1	6
1.2.2 EVK-NINA-B222 and EVK-NINA-W1x2	6
1.2.3 EVK-NINA-W1x6	6
1.3 I/O allocation.....	7
1.4 Jumper description	8
1.4.1 Default jumper configuration	10
1.5 LEDs.....	10
1.5.1 RGB-LED jumper configuration	11
1.6 Connectors	12
1.7 Buttons.....	12
1.8 Configuration options	13
1.8.1 UART	13
1.8.2 Power supply.....	13
1.8.3 Low-power Oscillator (LPO)	14
1.8.4 RMI to PHY	14
1.8.5 SPI slave interface	14
2 Setting up the evaluation board.....	16
2.1 EVK without software (open CPU).....	16
2.2 EVK with u-blox connectivity software.....	17
2.2.1 Starting up	17
2.2.2 Getting the latest software	17
Appendix	18
A Layout EVK-NINA-W1x1, -W1x2 and EVK-NINA-B221, -B222	18
B Layout EVK-NINA-W1x6.....	18
C Schematic drawing EVK-NINA-W1x1, -W1x2 and EVK-NINA-B221, -B222.....	19
D Schematic drawing EVK-NINA-W1x6	23
E Glossary	27
Related documents	28
Revision history	28
Contact.....	29

1 Product description

1.1 Overview

The EVK-NINA-W1/EVK-NINA-B2 evaluation kit includes an evaluation board, which can be used as a reference design for the NINA-W1 or NINA-B2 series modules, a quick start guide, and a USB cable.

For the NINA-B221 and the NINA-W1x1 module, the evaluation board is prepared with a U.FL coaxial connector for connecting the external antenna. The NINA-B222 and the NINA-W1x2 modules have an onboard PIFA antenna. The NINA_W1x6 have a PCB trace antenna; thus the EVK-NINA-B222, the EVK-NINA-W1x2 and EVK-NINA-W1x6 evaluation boards do not have a U.FL connector.

The main features of the EVK-NINA-W1/EVK-NINA-B2 are:

- Available in several variants:
 - NINA-B221 and NINA-B222
 - NINA-W101 and NINA-W102
 - NINA-W131 and NINA-W132
 - NINA-W151 and NINA-W152
 - NINA-W106 and NINA-W156
- All of the module pins are available at connectors or jumpers
- Can be powered through USB (J8) or external power supply (J23)
- Equipped with a Quad High Speed USB to Multipurpose UART/MPSSSE IC (FT4232) that allows serial communication and flashing over USB.

The EVK-NINA-W1/EVK-NINA-B2 evaluation kits are available in the following variants, depending on the NINA module that is mounted on the EVK:

- EVK-NINA-B221 – Evaluation kit for NINA-B221 module, RF port available on U.FL connector (J21)
- EVK-NINA-B222 – Evaluation kit for NINA-B222 module with onboard PIFA antenna
- EVK-NINA-W101 – Evaluation kit for NINA-W101 module, RF port available on U.FL connector (J21)
- EVK-NINA-W102 – Evaluation kit for NINA-W102 module with onboard PIFA antenna
- EVK-NINA-W106 – Evaluation kit for NINA-W106 module with a PCB trace antenna
- EVK-NINA-W131 – Evaluation kit for NINA-W131 module, RF port available on U.FL connector (J21)
- EVK-NINA-W132 – Evaluation kit for NINA-W132 module with onboard PIFA antenna
- EVK-NINA-W151 – Evaluation kit for NINA-W151 module, RF port available on U.FL connector (J21)
- EVK-NINA-W152 – Evaluation kit for NINA-W152 module with onboard PIFA antenna
- EVK-NINA-W156 – Evaluation kit for NINA-W156 module with a PCB trace antenna

This section describes the main connectors and settings that are required to get started. Figure 1, Figure 2 and Figure 3 shows the three different antenna variants of the EVK-NINA-W1/EVK-NINA-B2 evaluation board.

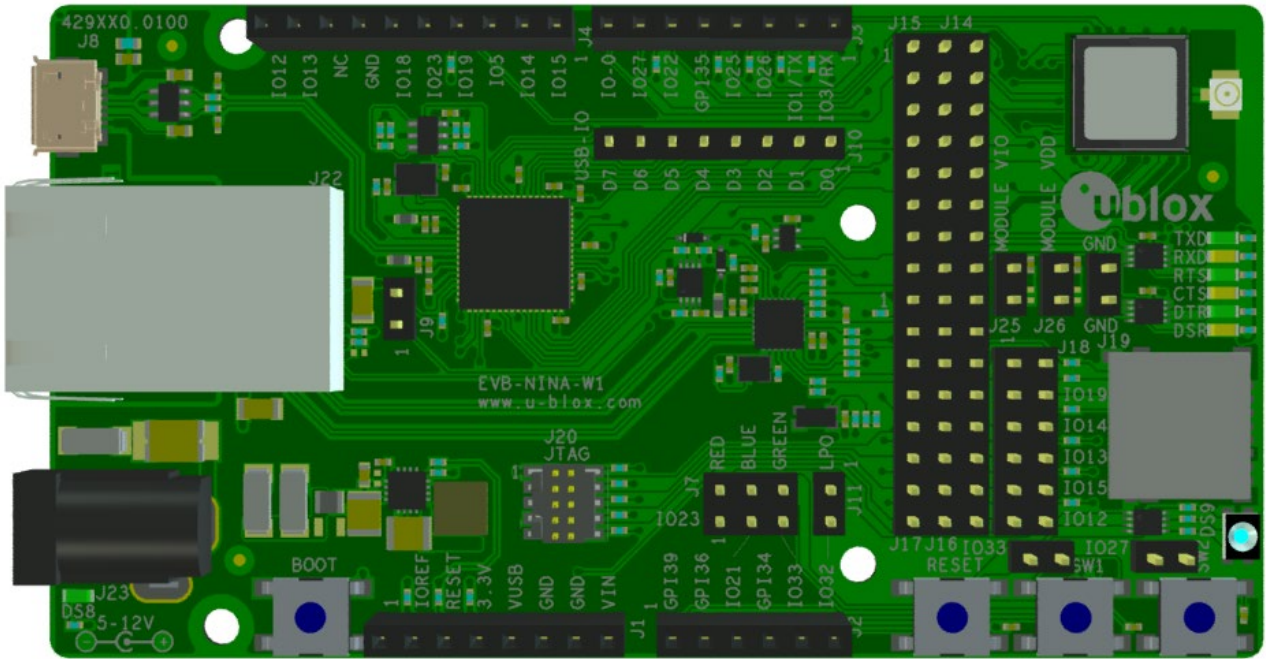

Figure 1: EVK-NINA-W1x1/ EVK-NINA-B2x1 evaluation board with U.FL connector for external antenna

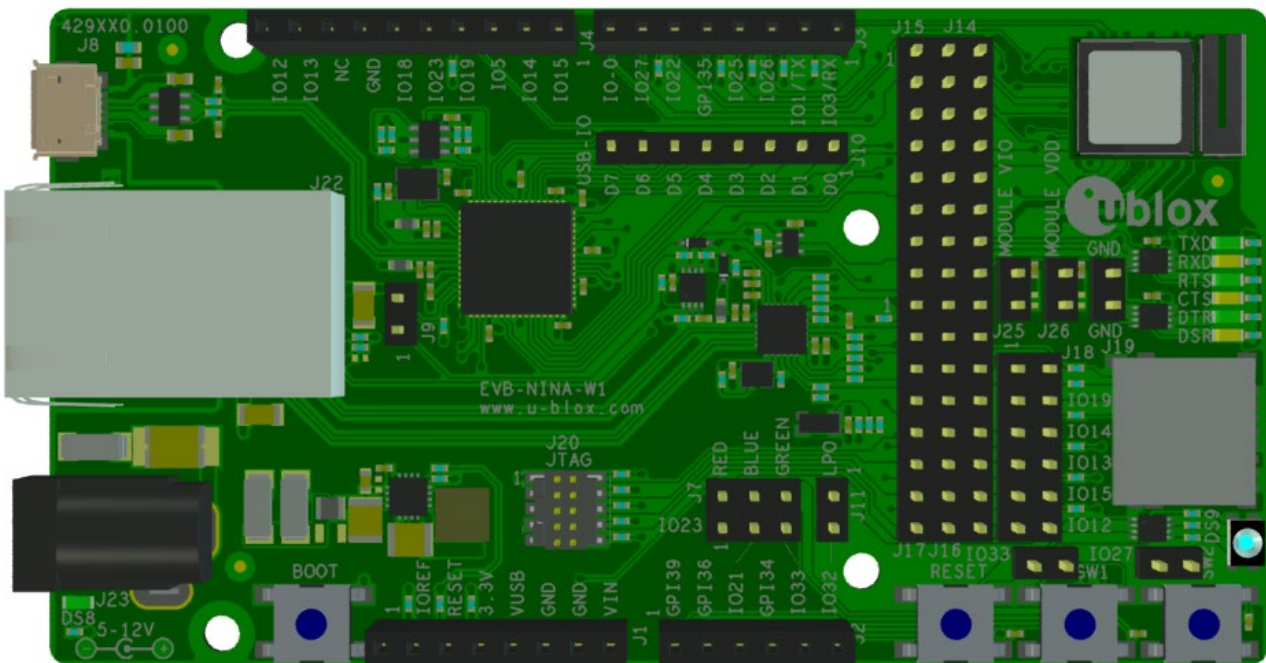

Figure 2: EVK-NINA-W1x2/ EVK-NINA-B2x2 evaluation board with onboard PIFA antenna

- ⚠ Take care while handling the EVK-NINA-B222 and EVK-NINA-W1x2. Applying force to the NINA module might damage the internal PIFA antenna.

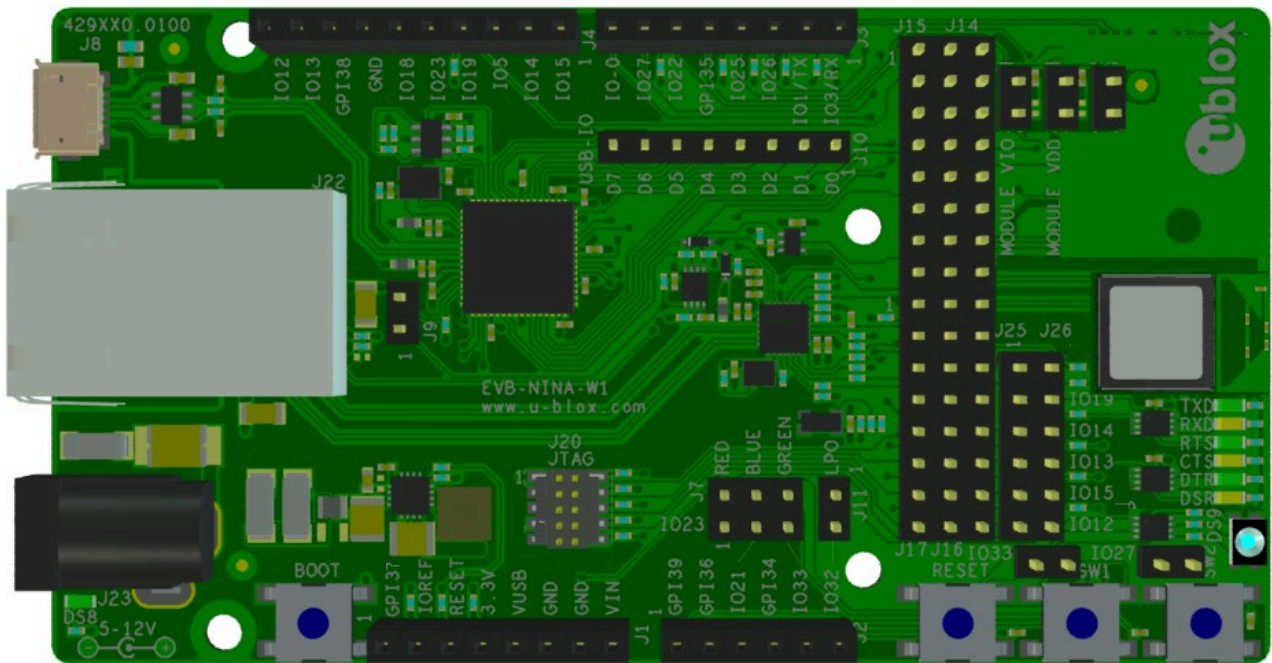

Figure 3: EVK-NINA-W1x6 evaluation board with internal PCB trace antenna

1.2 Kit includes

1.2.1 EVK-NINA-B221 and EVK-NINA-W1x1

The EVK-NINA-B221 and EVK-NINA-W1x1 evaluation kits include the following:

- EVK-NINA-B221 or EVK-NINA-W1x1 evaluation board
- 2.4 GHz foldable antenna (Ex-It 2400) with reverse polarity SMA connector
- RP-SMA - U.FL cable assembly, 100 mm length
- USB cable
- Thank you card

1.2.2 EVK-NINA-B222 and EVK-NINA-W1x2

EVK-NINA-B222 and EVK-NINA-W1x2 evaluation kits include the following:

- EVK-NINA-B222 and EVK-NINA-W1x2
- USB cable
- Thank you card

1.2.3 EVK-NINA-W1x6

EVK-NINA-W1x6 evaluation kits include the following:

- EVK-NINA-W1x6
- USB cable
- Thank you card

1.3 I/O allocation

The block diagram in Figure 4 provides a better understanding of how I/O signals from the module are made available at connectors and/or interfaces of the EVK.

Sixteen (16) I/O signals (on EVK-NINA-W1x6 17 signals) are available at the middle row of the I/O allocator. These signals can be distributed to connectors and/or interfaces on the EVK by use of jumpers to connect the associated middle and outer row pin(s).

The signals IO-12, IO-13, IO-14 and IO-15 can be disconnected from the J4 connector by not populating the corresponding jumpers at J18. This can be useful if the SDIO signals D2, D3, CLK, and CMD are directed to the SD card reader (J19).

Signals on the module not connected to any circuits (interfaces, LEDs and switches etc) on the board are connected directly to J1, J2, J3 or J4 connector.

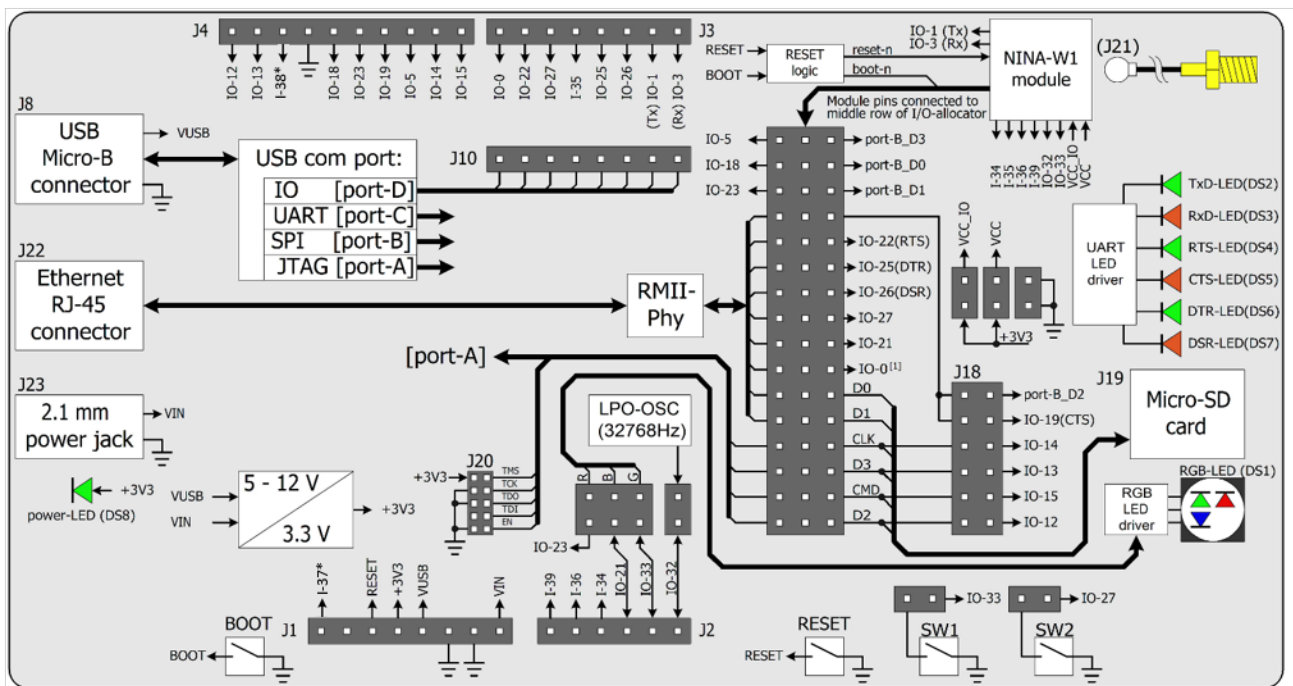

* Available only on EVK-NINA-W1x6.

Figure 4: Block diagram of EVK-NINA-W10

- When reset-n is released, the module pin 27 (IO-0) is read as boot-n (firmware upgrade). When IO-0 is connected to the module, it must be high during start up for normal operation.
- On EVK-NINA-W1x6 the Micro-SD card is placed on the bottom side. Additionally, the NINA-W1x6 module and the J25/J26 and GND pins have changed places.

1.4 Jumper description

Parameter	Description	Name	Default
Enable SW1	Jumper at J5-1_J5-2 connects switch 1 to module pin-7	J5	<input checked="" type="checkbox"/>
Enable SW2	Jumper at J6-1_J6-2 connects switch 2 to IO-27 (Jumper at J14-15_J14-16 must be populated to connect IO27 to module pin-18)	J6	<input checked="" type="checkbox"/>
Enable RGB-LED	Jumper at J7-1_J7-2 connects RED LED to IO-23 (Jumper at J15-3_J14-5 must be populated to connect IO23 to module pin-1)	J7-RED	<input checked="" type="checkbox"/>
	Jumper at J7-3_J7-4 connects BLUE LED to IO-21 (Jumper at J16-1_J16-2 must be populated to connect IO21 to module pin-8)	J7-BLUE	<input checked="" type="checkbox"/>
	Jumper at J7-5_J7-6 connects GREEN LED to IO-33	J7-GREEN	<input checked="" type="checkbox"/>
Enable LPO	Jumper J11 connects the LPO with IO-32 (NINA-W106 and NINA-W156 only).	J11	
IO/Interface select	Module pin to IO/Interface distribution	J14	See Table 3
IO/Interface select	Module pin to IO/Interface distribution	J15	See Table 3
IO/Interface select	Module pin to IO/Interface distribution	J16	See Table 3
IO/Interface select	Module pin to IO/Interface distribution	J17	See Table 3
IO/Interface select	Module pin to IO/Interface distribution	J18	See Table 3
Enable VCC_IO	Connects EVK internal 3.3 V to module pin-9 to supply module VCC_IO	J25	<input checked="" type="checkbox"/>
Enable VCC	Connects EVK internal 3.3 V to module pin-10 to supply module VCC	J26	<input checked="" type="checkbox"/>

Table 1: EVK-NINA-W1/EVK-NINA-B2 jumper descriptions

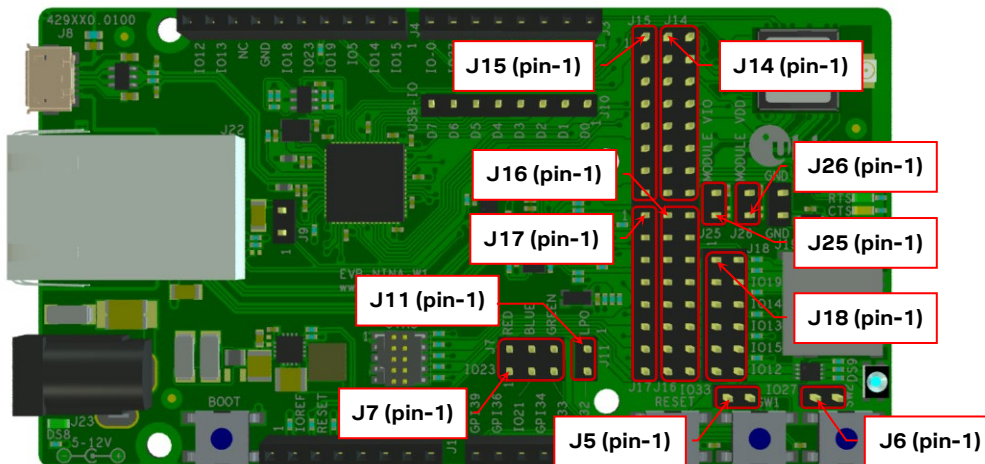

Figure 5: Jumper positions on the EVK. J25-J26 have swapped position with the module on the EVB-NINA-W1x6 board.

Middle row jumper pin	Connected to
J14-1	Module pin-28
J14-3	Module pin-29
J14-5	Module pin-1
J14-7	Module pin-21
J14-9	Module pin-20
J14-11	Module pin-16

Middle row jumper pin	Connected to
J14-13	Module pin-17
J14-15	Module pin-18
J16-1	Module pin-8
J16-3	Module pin-27
J16-5	Module pin-25
J16-7	Module pin-24
J16-9	Module pin-31
J16-11	Module pin-35
J16-13	Module pin-32
J16-15	Module pin-36

Table 2: Available module pins at the middle row of jumpers J14 and J16

Connected to	Left row jumper pin	Middle row jumper pin	Right row jumper pin	Connected to	Default
IO-5, J4 pin-3	J15-1	J14-1	J14-2	SPI_V_CS, U5-PB-3	[J15-1_J14-1]
IO-18, J4 pin-6	J15-2	J14-3	J14-4	SPI_V_CLK, U5-PB-0	[J15-2_J14-3]
IO-23, J4 pin-5	J15-3	J14-5	J14-6	SPI_V_MOSI, U5-PB-1	[J15-3_J14-5]
reserved	J15-4	J14-7	J14-8	J18 pin-1_3	[J14-7_J14-8]
reserved	J15-5	J14-9	J14-10	IO-22, J3 pin-6 (RTS)	[J14-9_J14-10]
reserved	J15-6	J14-11	J14-12	IO-25, J3 pin-4 (DTR)	[J14-11_J14-12]
reserved	J15-7	J14-13	J14-14	IO-26, J3 pin-3 (DSR)	[J14-13_J14-14]
reserved	J15-8	J14-15	J14-16	IO-27, J3 pin-7	[J14-15_J14-16]
reserved	J17-1	J16-1	J16-2	IO-21, J2 pin-3	[J16-1_J16-2]
reserved	J17-2	J16-3	J16-4	IO-0, J3 pin-8	[J16-3_J16-4]
reserved	J17-3	J16-5	J16-6	reserved	
reserved	J17-4	J16-7	J16-8	reserved	
Reserved	J17-5	J16-9	J16-10	J18 pin-5	[J16-9_J16-10]
Reserved	J17-6	J16-11	J16-12	J18 pin-7	[J16-11_J16-12]
Reserved	J17-7	J16-13	J16-14	J18 pin-9	[J16-13_J16-14]
Reserved	J17-8	J16-15	J16-16	J18 pin-11	[J16-15_J16-16]

Table 3: IO-allocation via jumpers J14, J15, J16, and J17

Connected to	Left row jumper pin	Right row jumper pin	Connected to	Default
J14-8	J18-1	J18-2	SPI_V_MISO, U5-PB-2	
J14-8	J18-3	J18-4	IO-19, J4 pin-4 (CTS)	[J18-3_J18-4]
J16-10	J18-5	J18-6	IO-14, J4 pin-2	[J18-5_J18-6]
J16-12	J18-7	J18-8	IO-13, J4 pin-9	[J18-7_J18-8]
J16-14	J18-9	J18-10	IO-15, J4 pin-1	[J18-9_J18-10]
J16-16	J18-11	J18-12	IO-12, J4 pin-10	[J18-11_J18-12]

Table 4: IO-allocation via jumper J18

1.4.1 Default jumper configuration

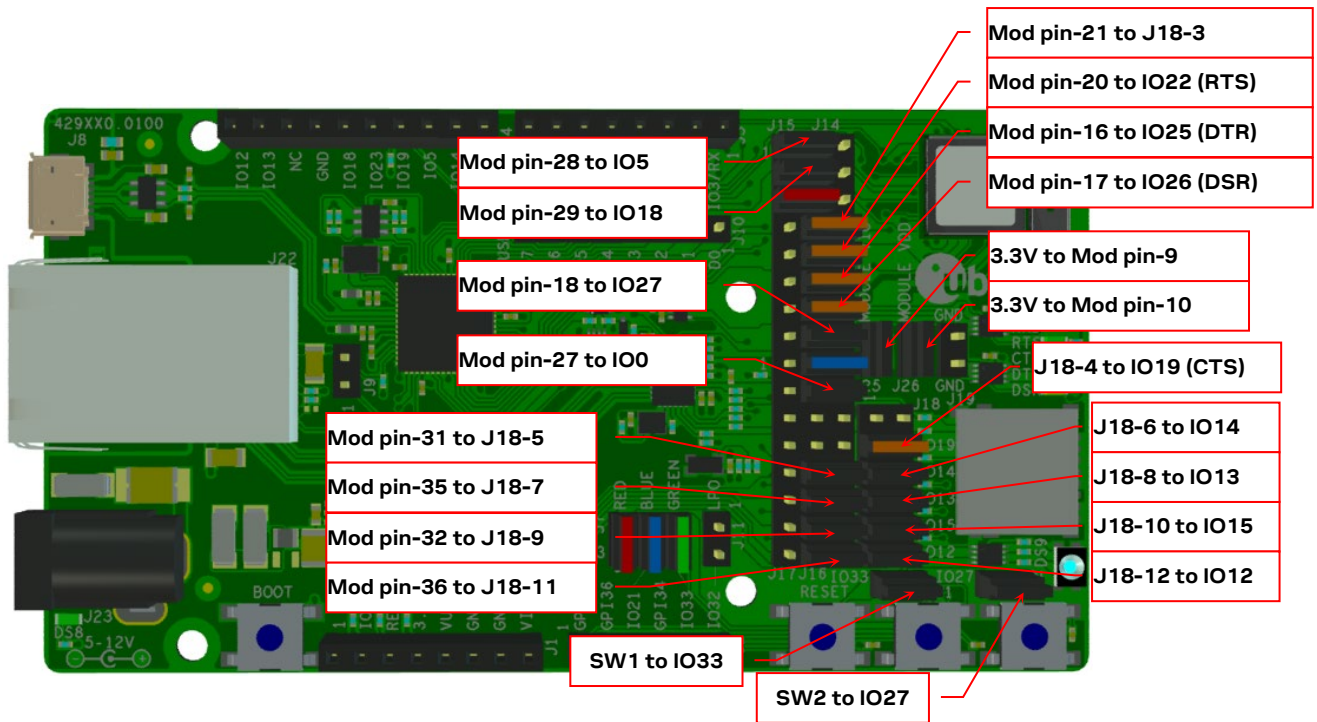

Figure 6: Jumper configuration to enable UART, IOs, and switches 1 and 2. J25-J26 (with Mod pin-9 and pin-10) have swapped positions with the module on the EVB-NINA-W1x6 board

1.5 LEDs

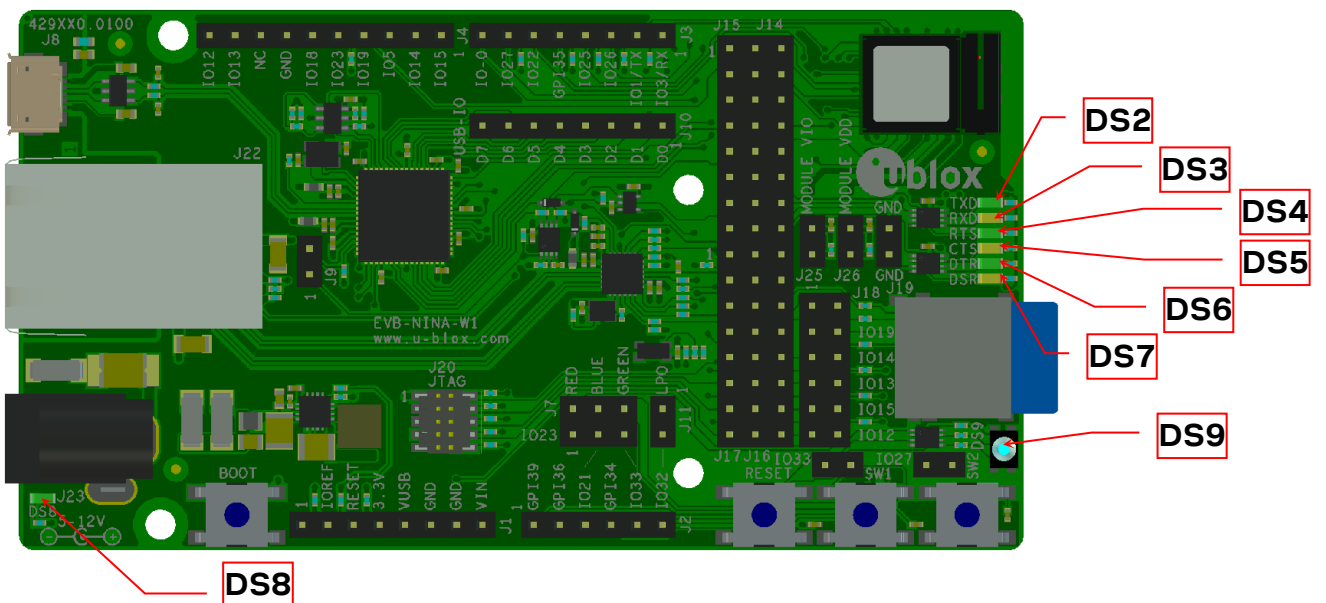

Figure 7: Position of LEDs on EVK-NINA-W1/EVK-NINA-B2. The SD card slot is moved to the bottom side and the DS2-DS7 LEDs are moved closer to DS9 on EVB-NINA-W1x6

Function	Description	Name	Color
Power LED	Supplied from the EVK 3.3 V DC/DC converter	DS8	Green
UART TxD	Flashing LED indicates UART Tx activity (output from the module)	DS2	Green
UART RxD	Flashing LED indicates UART Rx activity (input to the module)	DS3	Amber
UART RTS	LED indicates UART RTS status (output from the module)	DS4 ^[1]	Green

UART CTS	LED indicates UART CTS status (input to the module)	DS5 ^[1]	Amber
UART DTR	LED indicates UART DTR status (output from the module)	DS6 ^[1]	Green
UART DSR	LED indicates UART DSR status (input to the module)	DS7 ^[1]	Amber
status	RGB LED shows status for u-connectXpress	DS9 ^[1]	RGB

See the data sheet for NINA-W10, NINA-W13, NINA-W15 and NINA-B2 for additional information.

Table 5: EVK-NINA-W1/EVK-NINA-B2 LEDs description

[1] To control the LEDs, the corresponding signal jumper(s) must be populated.

1.5.1 RGB-LED jumper configuration

The jumpers shown in Figure 7 must be inserted to connect the RGB-LED driver with the associated module pins.

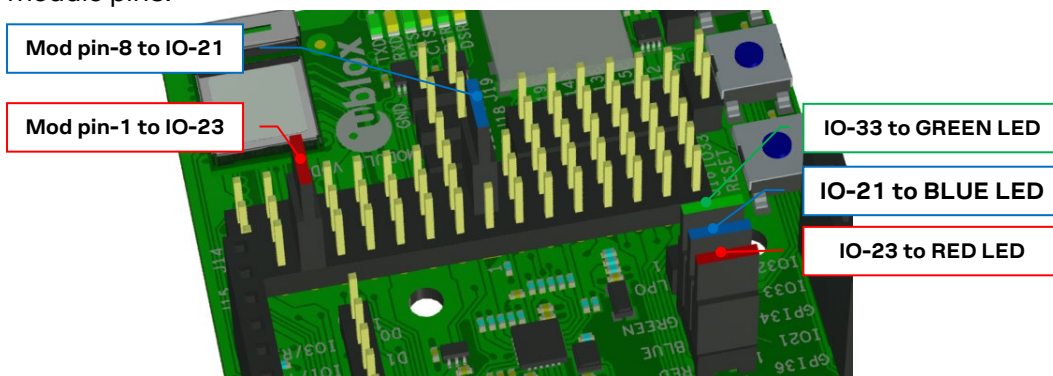
Figure 8: RGB-LED to IO signals jumpers

Some LEDs must be disabled when the EVK is configured to use the RMII to PHY or the LPO. See the corresponding chapters for more information.

1.6 Connectors

The available connectors on the EVK-NINA-W1/EVK-NINA-B2 board are shown in Figure 9.

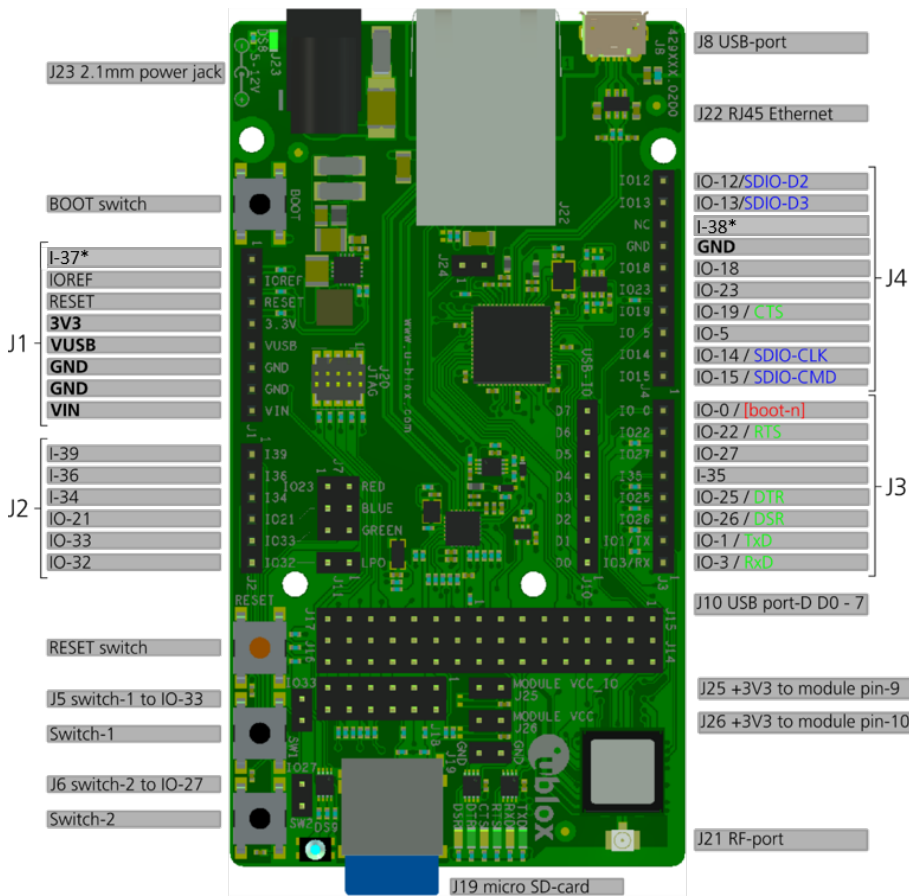

* Available on EVK-NINA-W1x6

Figure 9: EVK-NINA-W1/EVK-NINA-B2 connectors. The SD card slot is on the bottom side and the DS2-DS7 LEDs are moved closer to DS9 on EVB-NINA-W1x6. J25-J26 have swapped position with the module on the EVB-NINA-W1x6 board.

Connector	Description
J1, J2, J3, J4	Connectors for accessing the NINA-W1 IO signals (GPIO)
J8	USB connector; type Micro-B
J10	Reserved
J21	RF-port at U.FL coaxial connector for external antenna (not used on EVK-NINA-B221 or EVK-NINA-W1x2)
J22	RJ45 connector, RMII to PHY
J23	2.1 mm Power jack, positive center pin, 5 – 12 V

Table 6: EVK-NINA-W1/EVK-NINA-B2 connector descriptions

1.7 Buttons

The EVK-NINA-W1/EVK-NINA-B2 evaluation board has four buttons as explained in Table 7. Two of them can be connected to NINA pins via jumper configuration.

Button	Description
RESET	Reset button, triggers the reset logic that pulls module pin-19 low
BOOT	If reset is asserted pressing BOOT-switch will pull module pin-27 low
SW1	General function button connected to jumper J5 pin-2.
SW2	General function button connected to jumper J6 pin-2





Table 7: EVK-NINA-W1/EVK-NINA-B2 buttons descriptions

The SW1 must be disabled when the EVK is configured to enable the LPO. See the chapter 1.8.3 for more information.

1.8 Configuration options

Module pin number	ESP32 IO-signal	Primary function	Accessible at Jumper/Connector	Module pin number	ESP32 IO-signal	Primary function	Accessible at Jumper/Connector
1	GPIO-23		J14-5, [J4-5, J7-1] ⁽¹⁾	19	RESET-N	RESET	(J1-3 via logic)
2	GPI-34		J2-3	20	GPIO-22	UART_RTS	J14-9, [J3-7] ⁽¹⁾
3	GPI-39		J2-1	21	GPIO-19	UART_CTS	J14-7, [J4-4] ⁽¹⁾⁽²⁾⁽³⁾
4	GPI-36		J2-2	22	GPIO-1	UART_TXD	J3-2
5	GPIO-32		J2-6, J11-2	23	GPIO-3	UART_RXD	J3-1 ⁽³⁾
6,12, 14	GND		J1-6,-7, J4-7, J12-1,-2	24	GPIO-4		J16-7
7	GPIO-33		J2-5, J5-1, J7-5	25	GPIO-2		J16-5
8	GPIO-21		J16-1, [J2-4, J7-3] ⁽¹⁾	26, 30	GND		J1-6,-7, J4-7, J12-1,-2
9	VCC_IO		J25-2	27	GPIO-0		J16-3, [J3-8] ⁽¹⁾
10	VCC		J26-2	28	GPIO-5		J14-1, [J4-3] ⁽¹⁾
11	GPI-37 ⁽⁴⁾		J1-1	29	GPIO-18		J14-3, [J4-6] ⁽¹⁾
13	RF-port	Antenna	J21	31	GPIO-14		J16-9, [J4-2] ⁽¹⁾⁽²⁾
15	GPI-38 ⁽⁴⁾		J4-8	32	GPIO-15		J16-13, [J4-1] ⁽¹⁾⁽²⁾
16	GPIO-25	UART_DTR	J14-11, [J3-4] ⁽¹⁾	34	GPI-35		J3-5
17	GPIO-26	UART_DSR	J14-13, [J3-3] ⁽¹⁾⁽³⁾	35	GPIO-13		J16-11, [J4-9] ⁽¹⁾⁽²⁾
18	GPIO-27		J14-15, [J3-6, J6-1] ⁽¹⁾	36	GPIO-12		J16-15, [J4-10] ⁽¹⁾⁽²⁾

Table 8: Module pin to ESP32 IO signal conversion

-  (1) Connector/jumper placed inside the brackets indicates that a jumper must be positioned at the corresponding position of the IO distribution jumpers J14 – J17 if the IO-signal is to be presented at the designated connector/jumper as mentioned in Table 3.
-  (2) These IO signals require a second jumper to be positioned at the IO distribution jumper J18, as mentioned in Table 4.
-  (3) Control of these signals from an external host requires the removal of some resistors, as described in chapter 1.8.1.
-  (4) These signals are available only on EVK-NINA-W1x6.

1.8.1 UART

To enable a host to control the module through the UART interface on the J3 and J4 connectors, rather than through the USB connector, the RXD, CTS and DSR pins on the J3 and J4 connectors must be disconnected from the USB connector. By default, they indicate the signals as presented on the USB connector. Disconnect the signals by removing the resistors R35, R37 and R39. Removing the resistors disables control using the USB connector, and all control must subsequently be done through the J3 and J4 connectors.

1.8.2 Power supply

The supply voltage to the EVK-NINA-W1/EVK-NINA-B2 evaluation board can be sourced from the following connectors:

- USB (J8)

 Depending on your USB source, the USB supply current may be insufficient.

- External power supply (J23): The external supply voltage must be in the range 5 – 12 V

1.8.3 Low-power Oscillator (LPO)

To enable the LPO on the EVK-NINA-W1/EVK-NINA-B2 evaluation board, certain jumpers must be disconnected:

- Remove J7-5_J7-6, which control the green part of the RGB LED,
- Remove J5-1_J5-2, which enable the general-purpose switch SW1.
- Optional: Remove J16-9_J16-10, J6-11_J16-12, J16_13-J16_14 and J16_15-J16_16. These jumpers enable the MicroSD card connector, but contain pull-up resistors on the EVK-NINA-W1/EVK-NINA-B2 that affect the current consumption in STOP mode, ESP32 DEEP SLEEP mode, and ESP32 HIBERNATE power modes.

On EVK-NINA-W1x6, the green part of the RGB LED cannot be controlled.

LPO support in u-connectXpress is pending.

1.8.4 RMII to PHY

The jumpers shown in Figure 10 must be inserted to connect the 10Base-T/100Base-TX PHY with the associated module RMII interface pins.

When the RMII PHY is connected to the module, the “BLUE-LED” is not available at IO-21.

When the RMII PHY is used in u-connectXpress, neither the **RED_LED**, **BLUE_LED** or **GREEN_LED** signals are available. Consequently, the RGB LED is not lit at all.

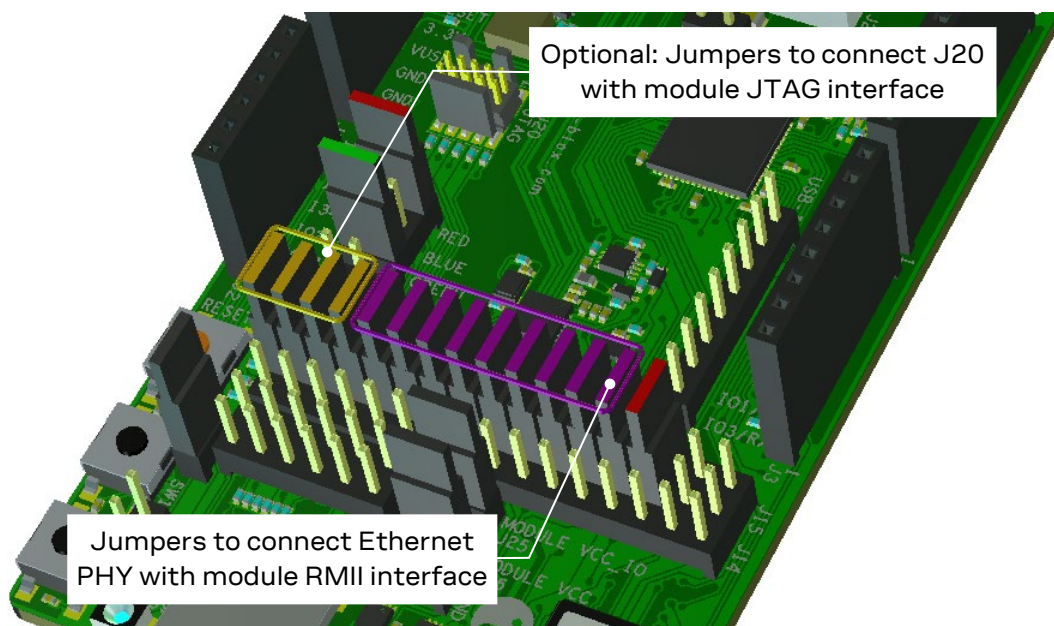

Figure 10: RMII to PHY jumper configuration

1.8.5 SPI slave interface

u-connectXpress can enable the **SPI_H** bus to operate as communication interface. For this feature to be automatically enabled, the host must be connected to the SPI bus according to Table 9. The host must also follow the requirements described in the u-blox SPI bus, protocol description [28]. This document describes how to configure alternative pins for the SPI using AT-commands over the UART/USB.

Function	I/O pin	Signal available on
SPI_DRDY	MOP-25	J16.5
SPI_CLK	MOP-31	J16.9
SPI_CS	MOP-32	J16.13
SPI_MOSI	MOP-35	J16.11
SPI_MISO	MOP-36	J16.15

Table 9: SPI signal descriptions

2 Setting up the evaluation board



The EVK-NINA-W10 is delivered without any software (open CPU) and the software must be developed by the user.

The EVK-NINA-B2, EVK-NINA-W13, and EVK-NINA-W15 are delivered with the u-blox connectivity software pre-flashed on the module.

-  The module is designed to be used only with the applicable software and only compatible software can be flashed on the module.

Before connecting to the module, download and install the latest u-blox s-center evaluation software from the u-blox website.

Plug in external supply power at connector J23 or connect J8 (USB type Micro B) to a USB host using the USB cable. The status light (DS8) will turn green, indicating that the internal EVK 3.3 V is on.

-  When using the evaluation board with external antenna, before powering up the EVK, ensure that you have connected the 2.4 GHz antenna with the U.FL antenna connector (J21). Failing to do so may cause undesired operation.
-  Be careful to check polarity before connecting external power supply to the evaluation board. Center conductor is positive (+) and the ring is negative (-).
-  The current consumption during startup of the evaluation board can be high.

The operating system will install the correct COM port drivers automatically. The drivers will need to be installed only when you connect the unit to a new computer for the first time. For more information about the COM ports and their configuration, see the FTDI FT4232H Datasheet [6].

One COM port will automatically be assigned to the unit by the Windows OS. To view the assigned COM ports on Windows 7, follow the steps mentioned below:

- Open the **Control Panel** and click **Hardware and Sound**.
- Click **Device Manager** in **Devices and Printers**. This will open the Device Manager window where you can view the assigned COM ports.

2.1 EVK without software (open CPU)

The chapter is applicable to the following EVKs.

- EVK-NINA-W101
- EVK-NINA-W102
- EVK-NINA-W106

When using the NINA-W10 open CPU variant, it is not possible to download the u-blox connectivity software.

The NINA-W10 open CPU variants are to be used when developing custom software based on the Espressif SDK ESP-IDF. Before compiling custom software, the ESP-IDF must be configured for the NINA-W10 open CPU variant.

More information on this topic can be found in the NINA-W1 system integration manual [7].

2.2 EVK with u-blox connectivity software

This section is applicable for the following EVKs:

- EVK-NINA-B221
- EVK-NINA-B222
- EVK-NINA-W131
- EVK-NINA-W132
- EVK-NINA-W151
- EVK-NINA-W152
- EVK-NINA-W156

2.2.1 Starting up

Perform the following steps to enable communication with the module:

1. Start the u-blox s-center evaluation software.
2. Use the default baud rate 115200, 8N1 with flow control. Now, it is possible to communicate with the module through AT commands.

For a list of available AT commands, see the u-blox short range AT commands manual [5].

2.2.2 Getting the latest software

Go to the u-blox support web page to obtain the latest available software. Instructions on reflashing the evaluation board can be found in the Software section of the NINA-B2 system integration manual [8] or the NINA-W1 system integration manual [7].

Appendix

A Layout EVK-NINA-W1x1, -W1x2 and EVK-NINA-B221, -B222

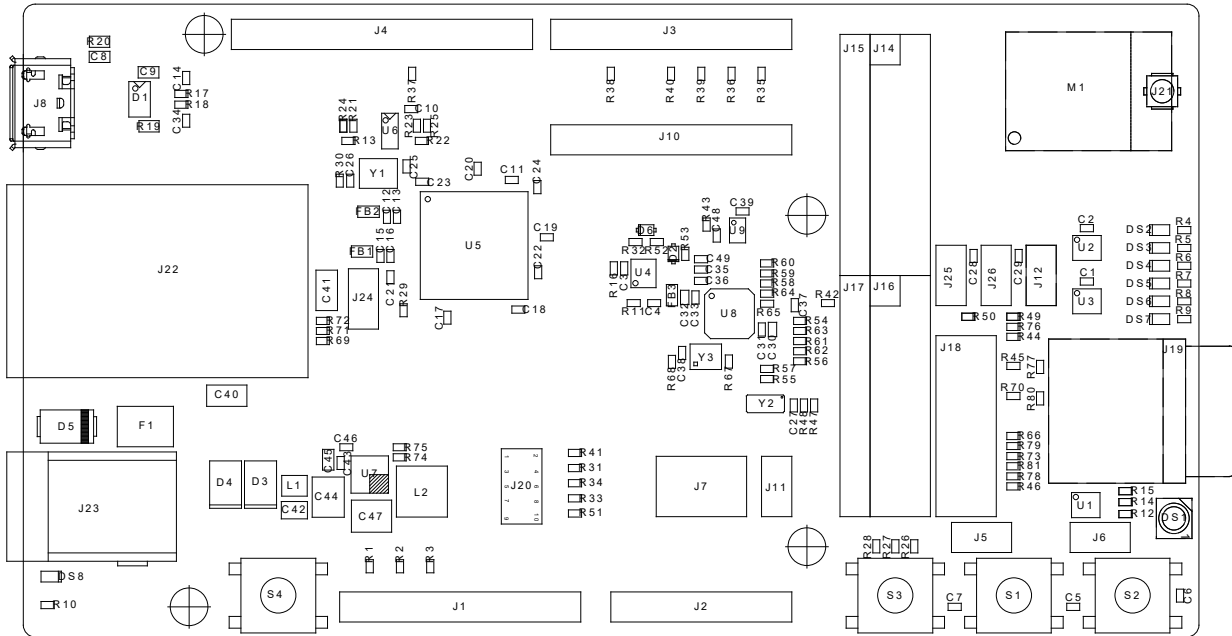

Figure 11: Component side layout of EVK-NINA-W1x1, EVK-NINA-W1x2, EVK-NINA-B21 and EVK-NINA-B222.

B Layout EVK-NINA-W1x6

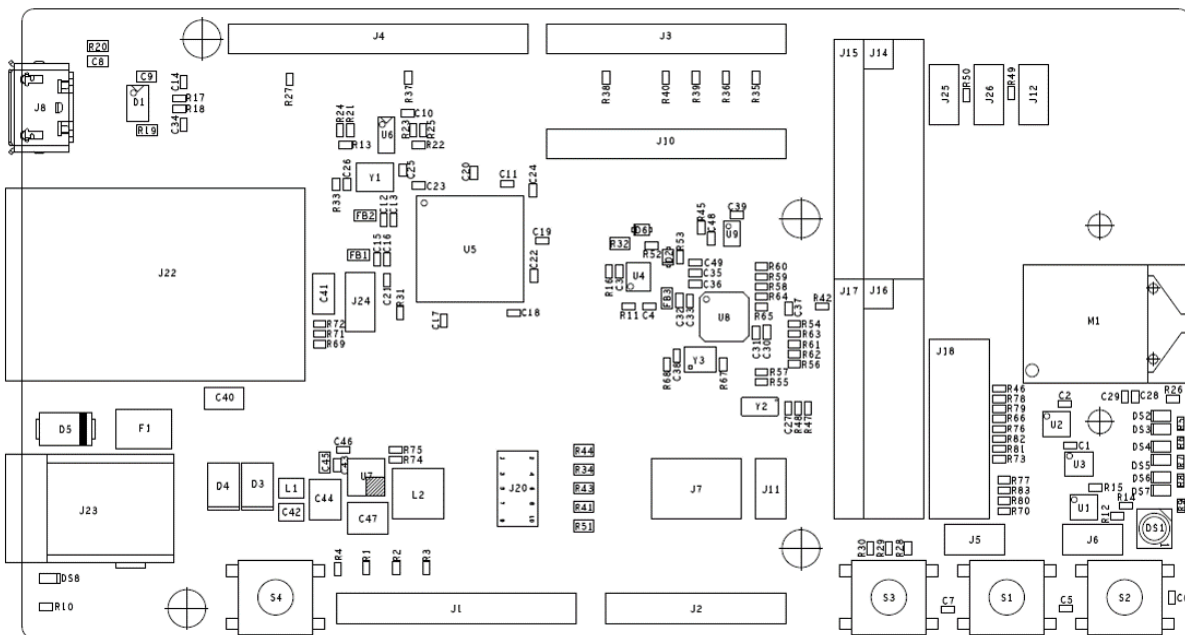

Figure 12: Component side layout of EVK-NINA-W1x6.

C Schematic drawing EVK-NINA-W1x1, -W1x2 and EVK-NINA-B221, -B222

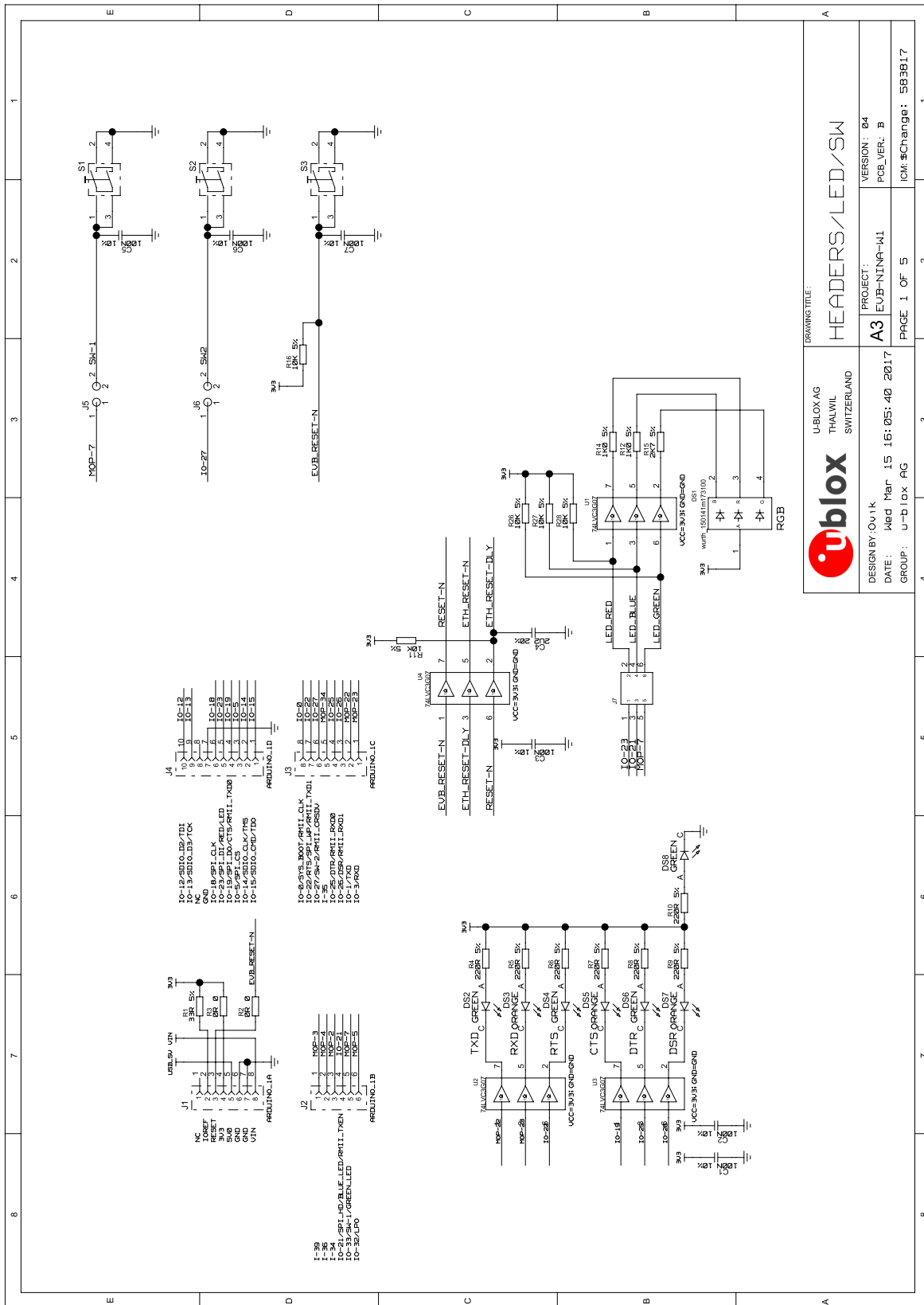

Figure 13: Schematic drawings 1/4 of EVK-NINA-W1x1, -W1x2 and EVK-NINA-B221, -B222

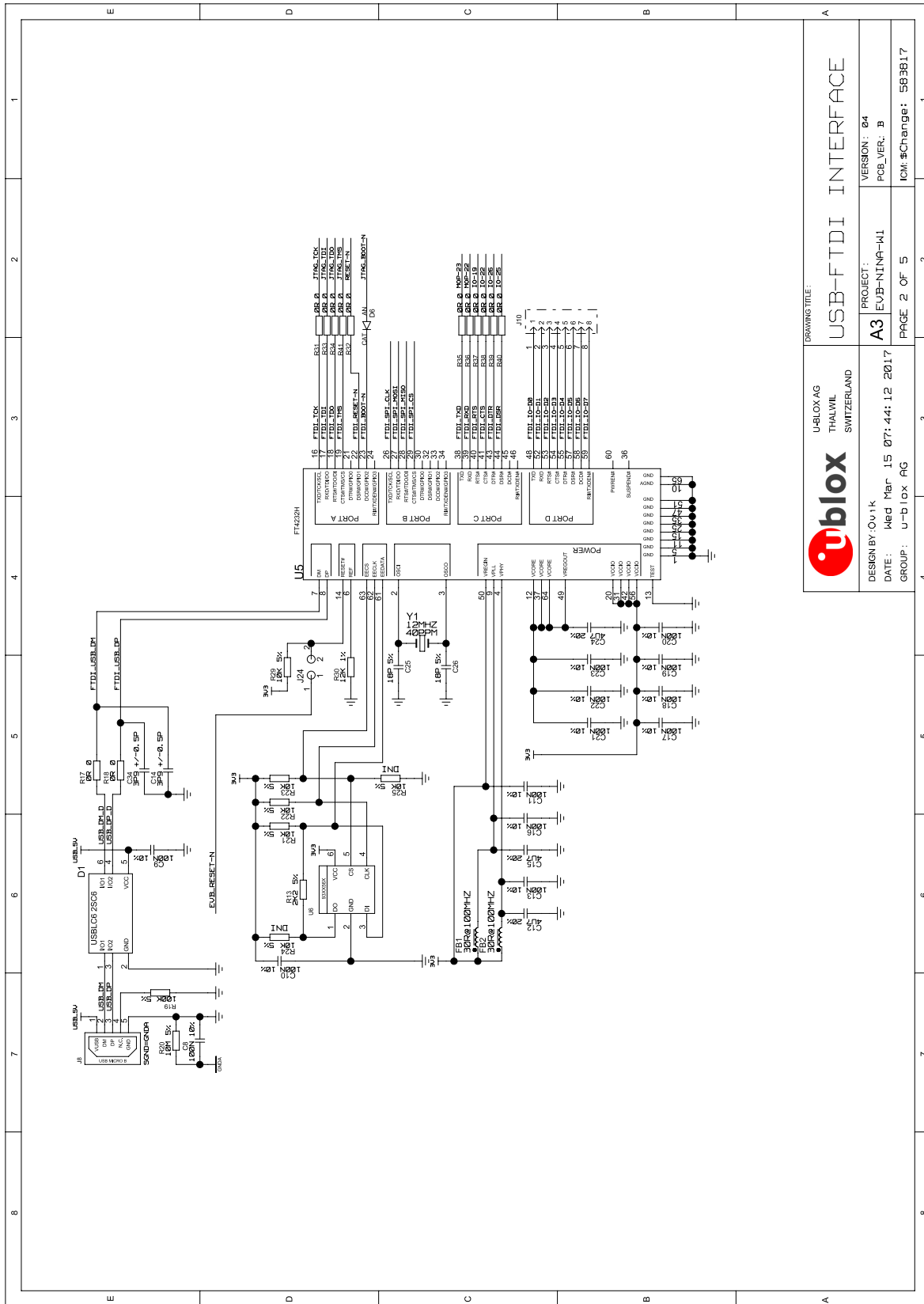

Figure 14: Schematic drawings 2/4 of EVK-NINA-W1x1, -W1x2 and EVK-NINA-B221, -B222

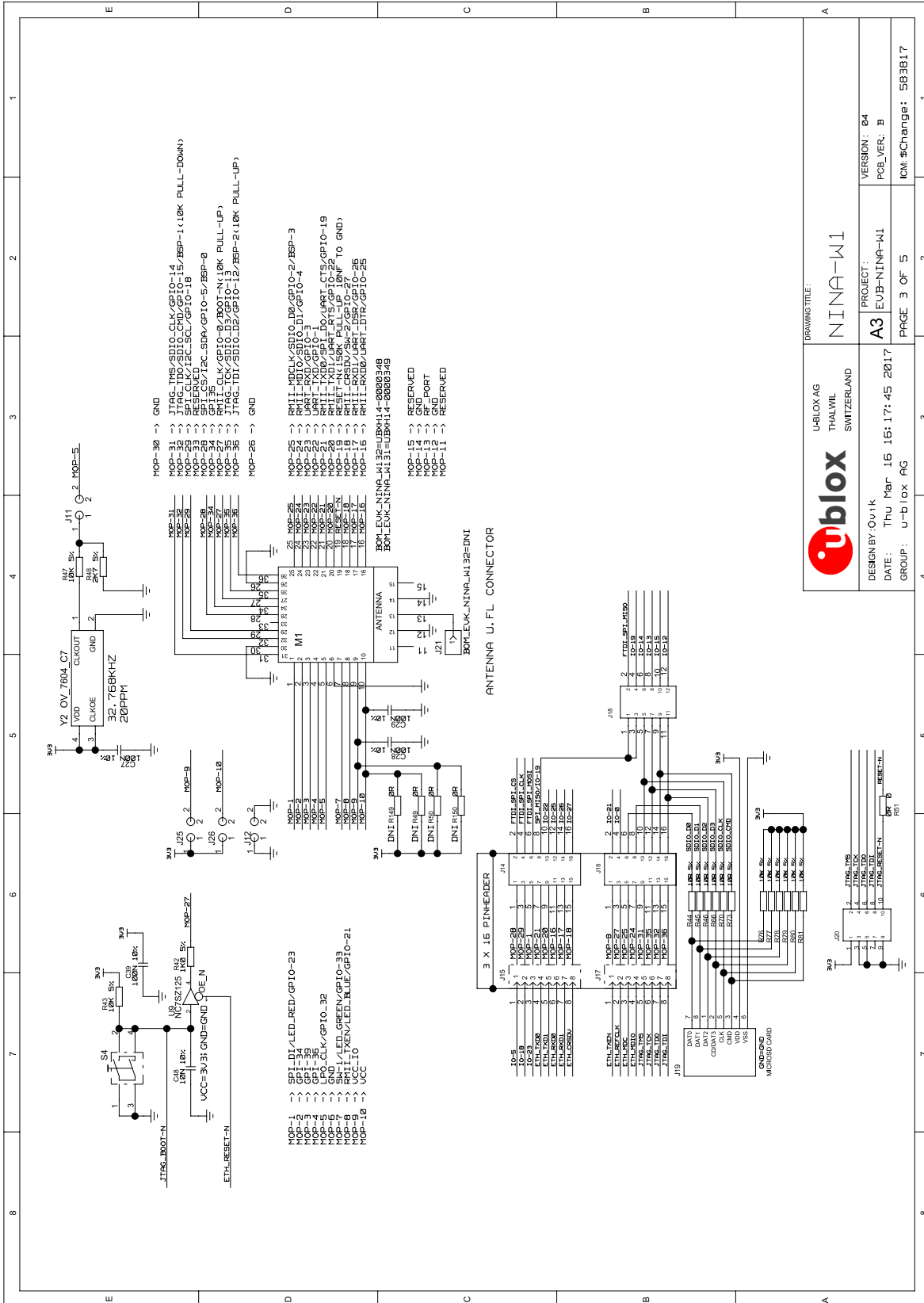
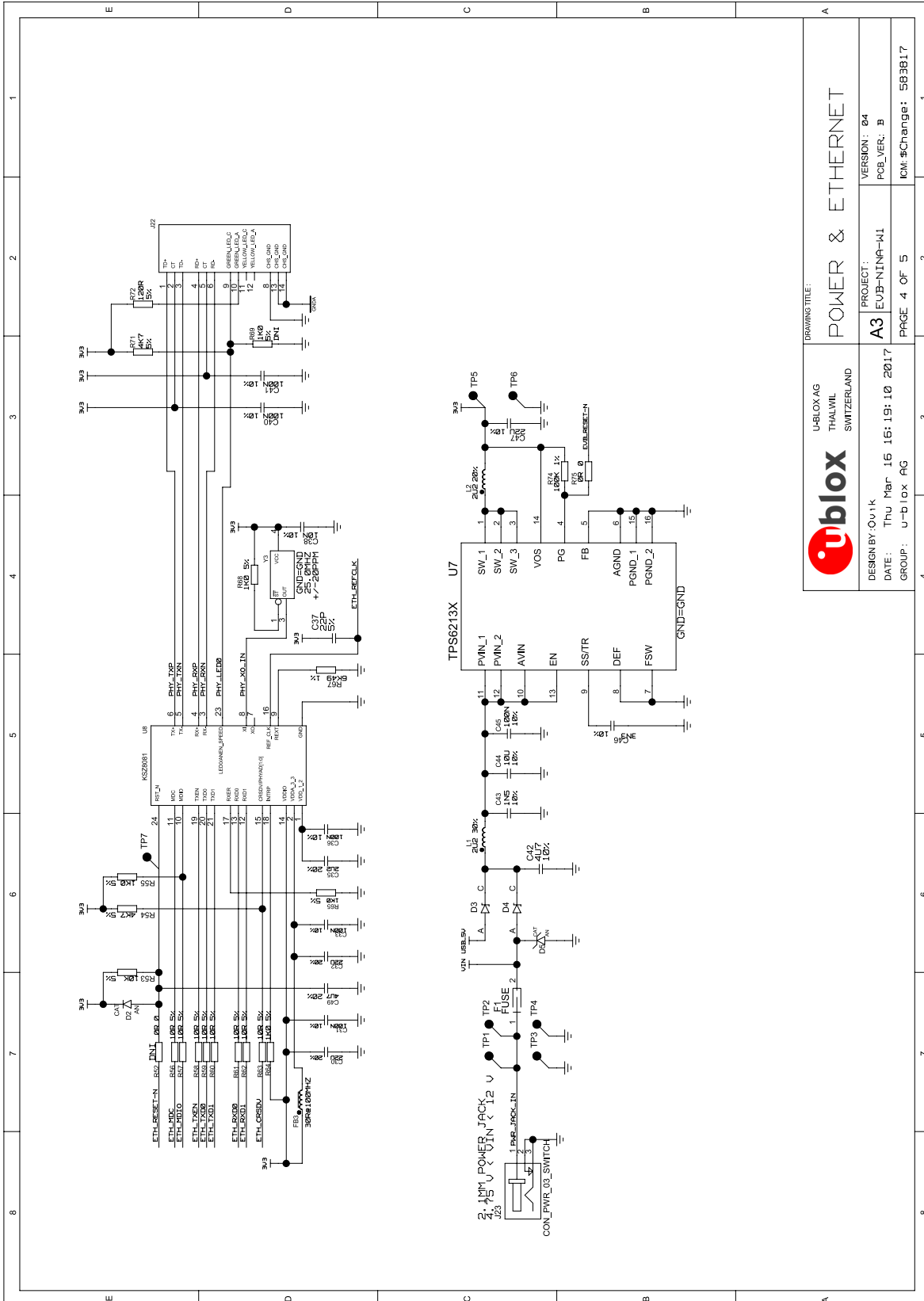

Figure 15: Schematic drawings 3/4 of EVK-NINA-W1x1, -W1x2 and EVK-NINA-B221, -B222



DRAWING TITLE:		POWER & ETHERNET	
L-BLOX AG THALWIL SWITZERLAND		VERSION: 04	
DESIGNBY: Ovi.k		PROJECT: A3 EVB-NINA-W1	
DATE: Thu Mar 16 16:19:10 2017		PCB_VER: B	
GROUP: U-blox AG		PAGE 4 OF 5	
		ICM-Change: 583817	

Figure 16: Schematic drawings 4/4 of EVK-NINA-W1x1, -W1x2 and EVK-NINA-B221, -B222

D Schematic drawing EVK-NINA-W1x6

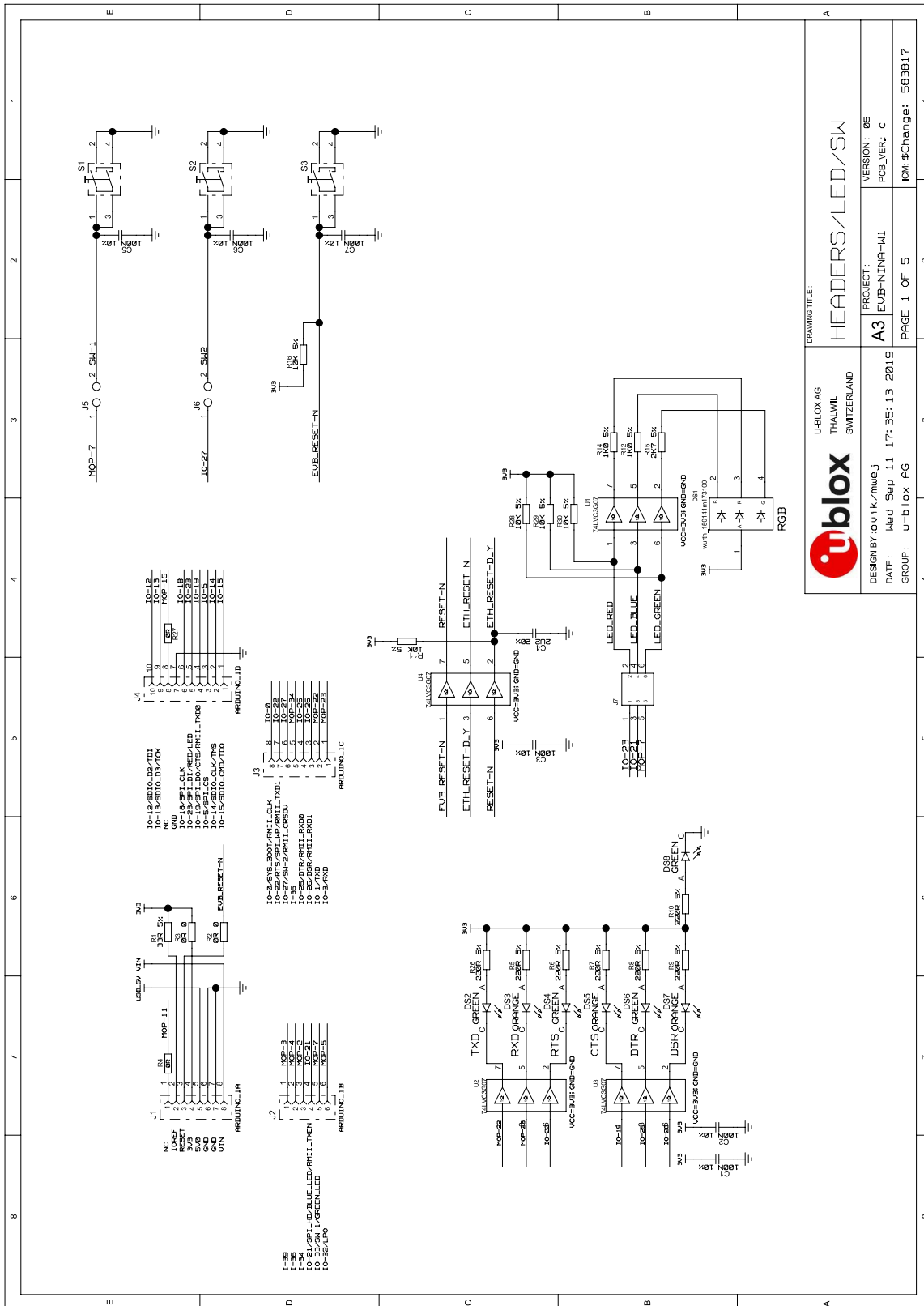

DRAWING TITLE	
HEADERS/LED/SW	
UBLOX AG THALWIL SWITZERLAND	
DESIGN BY: o.vik/muej	VERSION: 05
DATE: Wed Sep 11 17:35:13 2019	PCB_VER: c
GROUP: ublox AG	PROJECT: EVK-NINA-W1
PAGE 1 OF 5	ICM.#Change: 593817

Figure 17: Schematic drawings 1/4 of EVK-NINA-W1x6

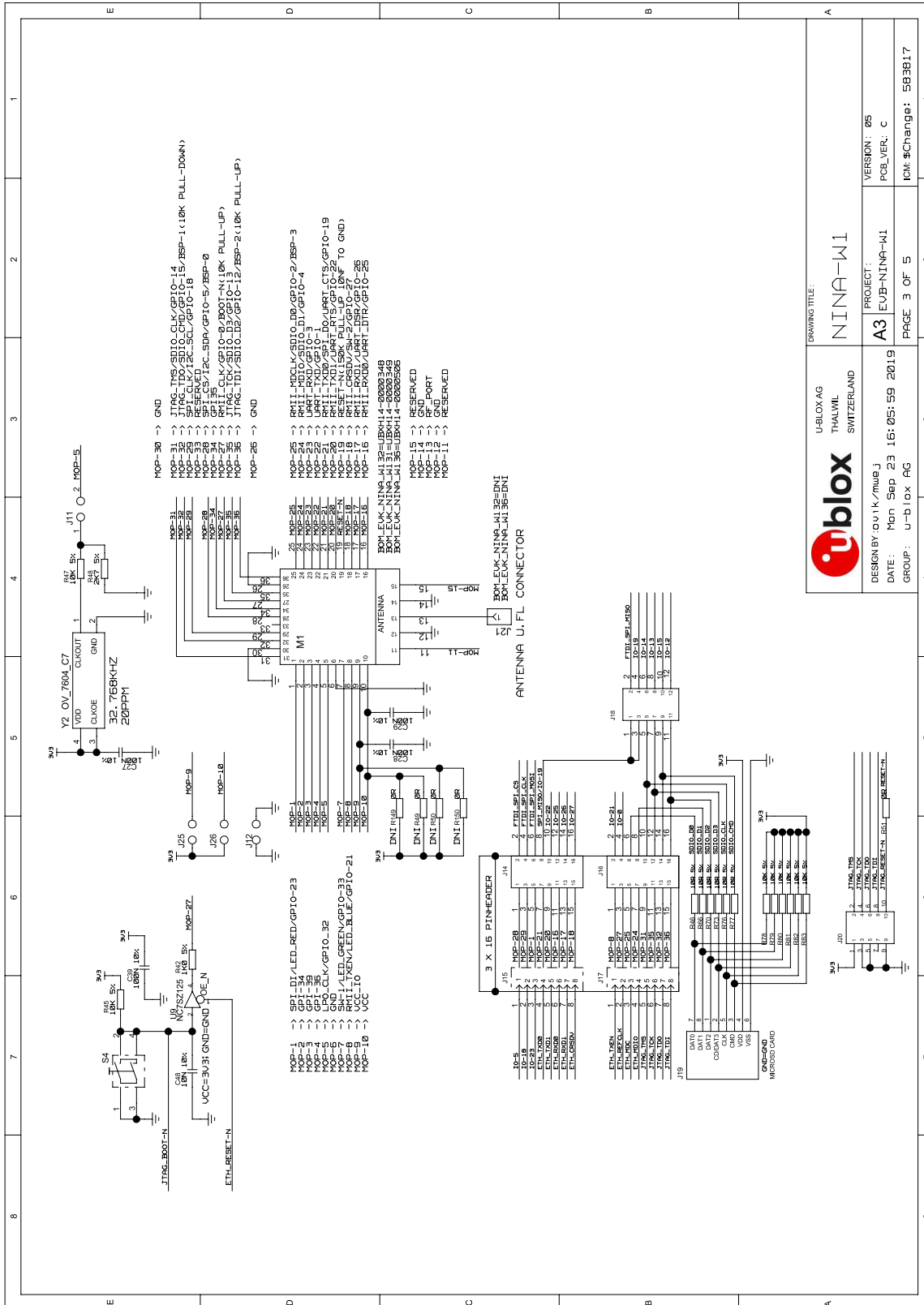

UBLOX AG
THALWIL
SWITZERLAND

u-blox

DESIGN BY: ovik/muej
DATE: Mon Sep 23 16:05:59 2019
GROUP: u-blox AG

DRAWING TITLE:
NINA-W1

PROJECT:
A3 EVB-NINA-W1

VERSION: 05
PUB.VER: C

PAGE 3 OF 5
IOM-#Change: 593817

Figure 19: Schematic drawings 3/4 of EVK-NINA-W1x6

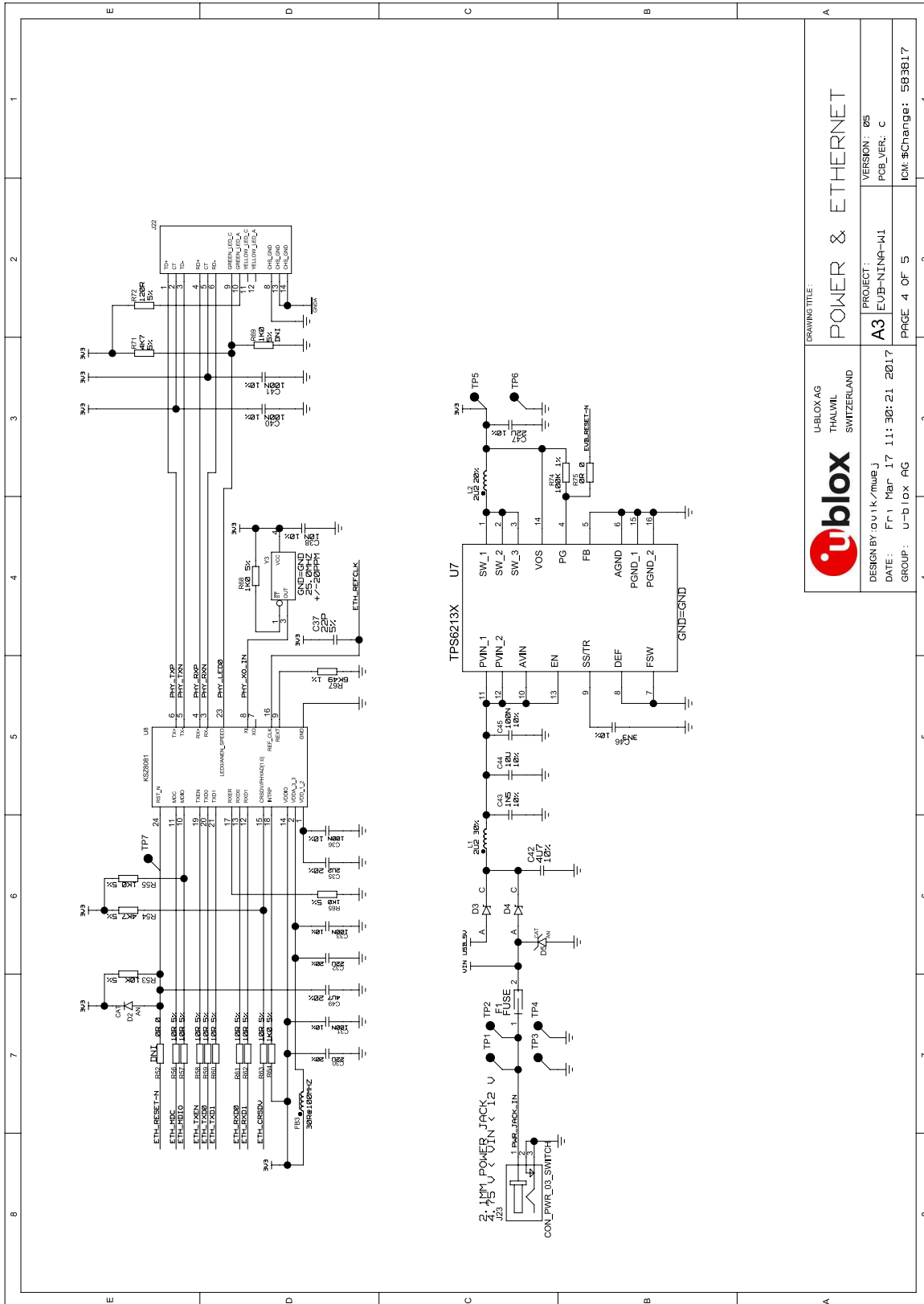

Figure 20: Schematic drawings 4/4 of EVK-NINA-W1x6

E Glossary

Name	Definition
COM	Communication
CTS	Clear to send
DSR	Data set ready
DTR	Data terminal ready
EVK	Evaluation kit
GND	Ground
GPI	General purpose input
GPIO	General purpose input/output
IO	Input-output
LED	Light-emitting diode
LPO	Low-power oscillator
PHY	Physical layer
U.FL	Miniature coaxial RF connector
USB	Universal serial bus
RF	Radio frequency
RMII	Reduced media-independent interface
RTS	Request to send
UART	Universal asynchronous receiver/transmitter
USB	Universal serial bus
VCC	IC power-supply pin

Table 10: Explanation of abbreviations used

Related documents

- [1] NINA-W10 data sheet, [UBX-17065507](#)
- [2] NINA-W13 data sheet, [UBX-17006694](#)
- [3] NINA-W15 data sheet, [UBX-18006647](#)
- [4] NINA-B2 data sheet, [UBX-18006649](#)
- [5] u-connect AT commands manual, [UBX-14044127](#)
- [6] FTDI FT4232H QUAD HIGH SPEED USB TO MULTIPURPOSE UART/MPSS IC Datasheet - http://www.ftdichip.com/Support/Documents/DataSheets/ICs/DS_FT4232H.pdf
- [7] NINA-W1 system integration manual, [UBX-17005730](#)
- [8] NINA-B2 system integration manual, [UBX-18011096](#)
- [9] u-blox SPI bus, protocol description, [UBX-20028725](#)

 For product change notifications and regular updates of u-blox documentation, register on our website, www.u-blox.com.

Revision history

Revision	Date	Name	Comments
R01	22-May-2017	ovik, kgom	Initial release.
R02	04-Jul-2017	ovik, mwej	Updated Figure 9 and Table 8 due to pin swap on connectors J2 and J3. Updated schematic drawing (Appendix A). Updated assigned COM ports in section 2.1.
R03	09-Nov-2017	kgom	Renamed this document as EVK-NINA-W13 User Guide and updated the content due to the availability of a separate user guide for the EVK-NINA-W10x evaluation kits (UBX-17057549).
R04	12-Mar-2018	cmag	Updated the software version to 1.0.0 in the last table on page 2 and the “Related documents and links” section.
R05	29-Nov-2018	fbro, kgom	Renamed this document. Restructured the information to include support for EVK-NINA-W1 and EVK-NINA-B2.
R06	08-Jul-2019	ovik	Minor updates.
R07	05-Sep-2019	flun	Clarified the status for RGB LED in Table 5 (section 1.5).
R08	10-Jul-2020	flun, hekf, mwej	Clarified the use of UART on the J3/J4 connector (section 1.8). Added products EVK-NINA-W106 and EVK-NINA-W156.
R09	02-Feb-2021	flun	Added sections 1.8.3 and 1.8.5 to describe LPO and SPI configuration, and included J11 jumper information in Table 1 and Figure 5. Moved the RMII to PHY section describing jumper configuration to section 1.8, configuration options. Clarified the availability of SPI_V in Table 3 and Table 4. Updated the kit content lists in section 1.2.