

# EVK-ODIN-W2

## Evaluation Kit for ODIN-W2

### User guide



### Abstract

This document describes how to set up the EVK-ODIN-W2 evaluation kit and provides information for evaluating and testing the u-blox ODIN-W2 multiradio standalone module with u-connectXpress software or for embedded custom applications using the Arm® Mbed™ development tool.

## Document information

<b>Title</b>	EVK-ODIN-W2		
<b>Subtitle</b>	Evaluation Kit for ODIN-W2		
<b>Document type</b>	User guide		
<b>Document number</b>	UBX-16007132		
<b>Revision and date</b>	R07	6-Sep-2019	
<b>Disclosure restriction</b>			

This document applies to the following products:

<b>Product name</b>	<b>Type number</b>	<b>Software version</b>	<b>PCN reference</b>
EVK-ODIN-W260	EVK-ODIN-W260-00	-	-
EVK-ODIN-W262	EVK-ODIN-W262-00	-	-

u-blox or third parties may hold intellectual property rights in the products, names, logos and designs included in this document. Copying, reproduction, modification or disclosure to third parties of this document or any part thereof is only permitted with the express written permission of u-blox.

The information contained herein is provided "as is" and u-blox assumes no liability for its use. No warranty, either express or implied, is given, including but not limited to, with respect to the accuracy, correctness, reliability and fitness for a particular purpose of the information. This document may be revised by u-blox at any time without notice. For the most recent documents, visit [www.u-blox.com](http://www.u-blox.com).

Copyright © u-blox AG.

# Contents

<b>Document information</b> .....	<b>2</b>
<b>Contents</b> .....	<b>3</b>
<b>1 Product description</b> .....	<b>4</b>
1.1 Overview.....	4
1.2 Kit includes.....	5
1.3 Jumper description.....	5
1.4 LEDs.....	5
1.5 Connectors.....	6
1.6 ODIN-W2 pin assignment.....	7
1.7 Buttons.....	7
1.8 Antenna connectors and internal antenna.....	7
1.9 Configurations options.....	8
1.9.1 UART selection for virtual COM port.....	8
1.9.2 A1 and A2 analog in vs digital I/O.....	8
1.9.3 ODIN-W2 boot.....	9
1.9.4 SWD Cortex debug connector.....	9
1.9.5 32.768 kHz LPO oscillator.....	10
<b>2 Getting started</b> .....	<b>11</b>
2.1 ST-link.....	11
2.2 Power up the evaluation board.....	11
2.3 Getting started with u-connectXpress software.....	11
2.3.1 Usage with UART flow control.....	12
2.3.2 Restore the u-connectXpress software firmware.....	12
2.4 Getting started with Arm® Mbed™.....	12
2.4.1 Github.....	12
2.4.2 Mbed OS 3.....	13
2.4.3 Mbed OS 5.....	13
<b>Appendix</b> .....	<b>14</b>
<b>A Updating the ST-link software</b> .....	<b>14</b>
A.1 Repairing an older board already connected to a Windows 10 PC.....	14
A.2 Updating the ST-link firmware of the debug chip.....	14
A.2.1 Upgrading the USB mass storage device driver.....	14
<b>B Schematic</b> .....	<b>15</b>
<b>C Glossary</b> .....	<b>20</b>
<b>Related documents</b> .....	<b>21</b>
<b>Revision history</b> .....	<b>21</b>
<b>Contact</b> .....	<b>22</b>

# 1 Product description

## 1.1 Overview

The ODIN-W2 is a compact and powerful stand-alone multiradio module, designed for Internet-of-Things gateway applications. The module includes embedded Bluetooth® stack, Wi-Fi driver, IP stack, and an application for wireless data transfer, all configurable using AT commands. The wireless support includes dual-mode Bluetooth v4.0 (BR/EDR and low energy) and dual-band Wi-Fi (2.4 and 5 GHz bands).

This document describes how to set up the EVK-ODIN-W2 evaluation kit and provides information for evaluating and testing the u-blox ODIN-W2 multiradio standalone module with u-connectXpress software or using the Arm® Mbed™ development tool. The main features of the EVK-ODIN-W2 are:

- RJ45 Ethernet connector for ODIN-W2 RMII-PHY interface
- Can be powered through USB or external power supply
- Onboard ST-Link v2.1 debugger
- 32.768 kHz LPO oscillator
- Pin headers in 1.8 V I/O domain and Arduino sockets in 3.3 V I/O domain
- Micro SD-card slot

The EVK-ODIN-W2 evaluation kit is available in the following two different versions depending on the ODIN-W2 series module that is mounted:

- EVK-ODIN-W260
- EVK-ODIN-W262

This section describes the main connectors and settings required to get started. Figure 1 shows the EVK-ODIN-W2 evaluation board.

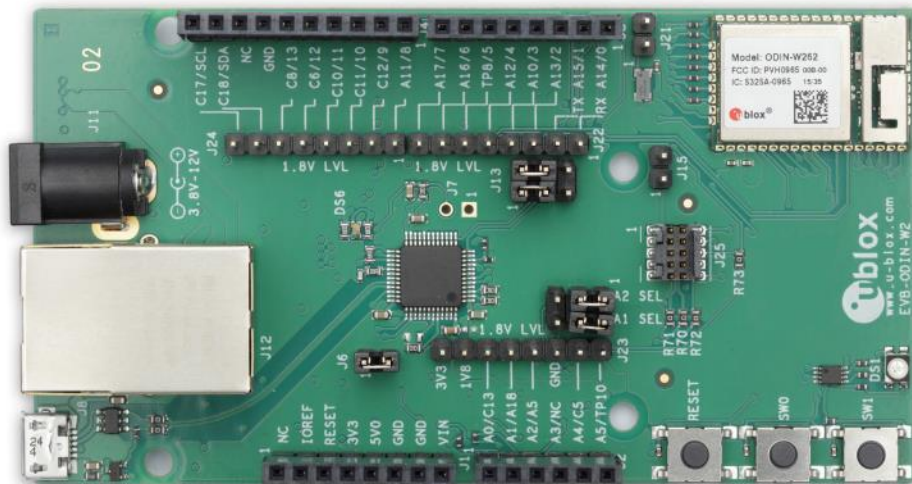

Figure 1: EVK-ODIN-W2 Evaluation kit overview

## 1.2 Kit includes

- EVK-ODIN-W2 evaluation board
- USB cable
- Quick Start card

## 1.3 Jumper description

Function	Description	Name	Default
Onboard debugger power	Selects whether to power the onboard debugger or not	J6	Mounted
Virtual COM port UART selection	Selects UART1 or UART3 for virtual COM port over USB	J13	UART1
A1 and A2 Analog in or Digital I/O selection	Selects whether the A1 and A2 socket pins on J2 connector can be used for analog in or Digital I/O.	J26	Digital I/O
32.768kHz LPO oscillator	Selects whether the 32.768 kHz LPO oscillator is connected to ODIN-W2 or not	J21	Not mounted
ODIN-W2 Boot	Selects whether to force ODIN-W2 into Boot mode or not	J15	Not mounted

**Table 1: EVK-ODIN-W2 jumper description**

## 1.4 LEDs

Function	Description	Name	Color
RGB/SPA status	RGB LED shows status for u-connectXpress. Also available for user applications in ARM Mbed. See the ODIN-W2 series data sheet [4].	DS1	RGB
Onboard debugger/virtual COM port status	Indicates status for the onboard debugger and virtual COM port over USB	DS6	Green or Red

**Table 2: EVK-ODIN-W2 LEDs description**

## 1.5 Connectors

The available connectors of the EVK-ODIN-W2 are shown in Figure 2.

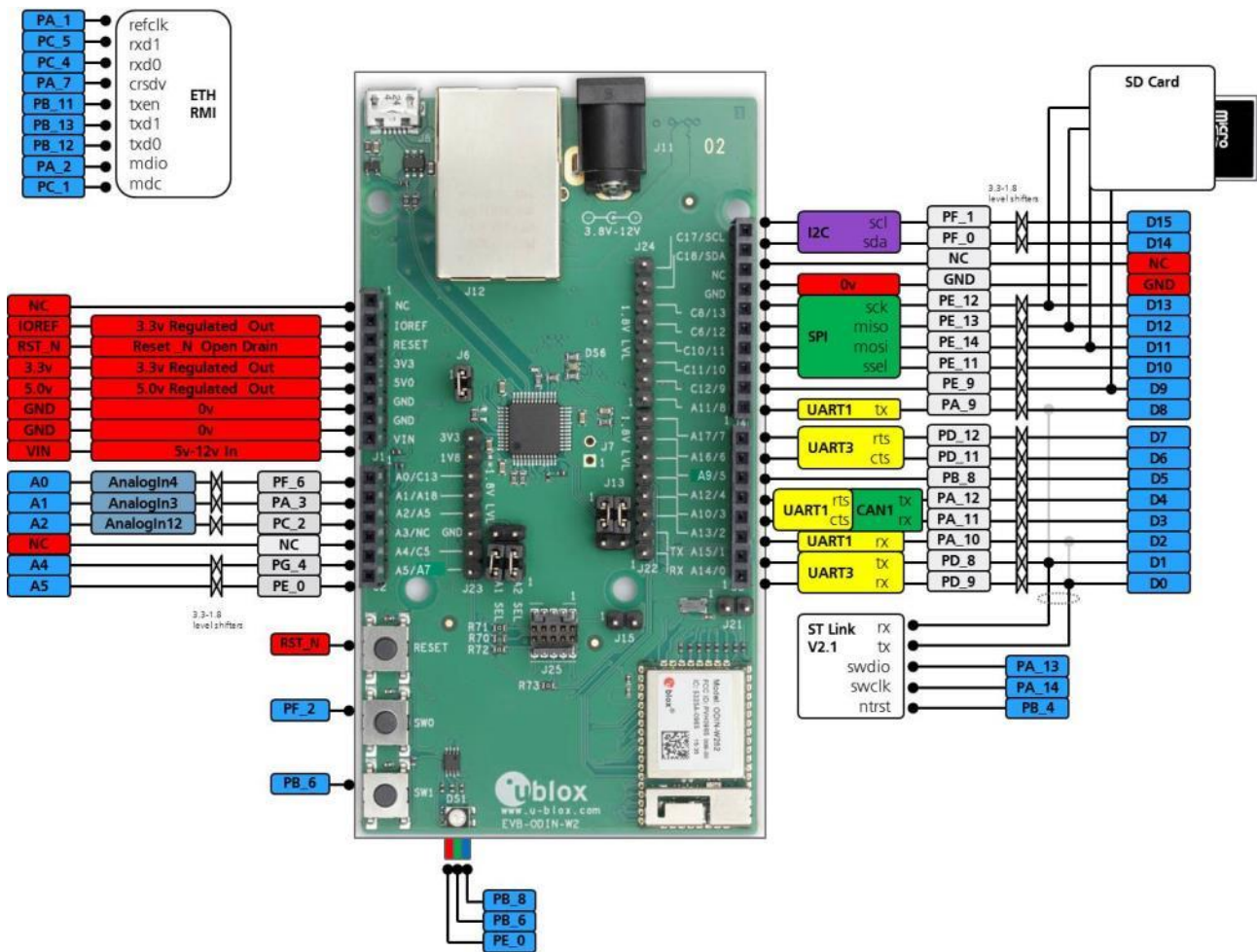

Figure 2: EVK-ODIN-W2 connectors and pin assignment

Connector	Description
J1, J2, J3, J4	Socket connectors with 3.3 V I/O level
J22, J23, J24	Pin header connectors with 1.8 V I/O level
J25	SWD Cortex debug connector for ODIN-W2
J12	RJ45 Ethernet connector
J11	Power jack (5-12 V), positive center
J8	USB connector

Table 3: EVK-ODIN-W2 connector description

On the EVK-ODIN-W2 evaluation board, there are two sets of connectors for accessing the ODIN-W2 pins. The socket connectors (J2, J3, and J4) placed closely to the board edges are connected to ODIN-W2 through level shifters and have 3.3 V I/O level. The pin header connectors (J22, J23, and J24) are directly connected to ODIN-W2 and have 1.8 V as I/O level.

- ⚠** Be careful to connect only the 1.8 V level or 3.3 V level pin in a pair if the ODIN-W2 pin is used as input. For example, A14 on J22 and J3.

## 1.6 ODIN-W2 pin assignment

Refer to ODIN-W2 series System Integration Manual [1] for information about pin assignment.

## 1.7 Buttons

The EVK-ODIN-W2 evaluation board has three buttons. All these buttons are directly connected to pins on the ODIN-W2 module. The SW0 and SW1 buttons are grounded only when pressed; otherwise they float. Hence, they need to be configured as pull-ups in the application software.

Button	Description
RESET	ODIN-W2 reset button connected to ODIN-W2 pin A1
SW0	General function button connected to ODIN-W2 pin A6
SW1	General function button connected to ODIN-W2 pin A8

Table 4: EVK-ODIN-W2 buttons description

## 1.8 Antenna connectors and internal antenna

The ODIN-W260 module has two RF antenna U.FL. coaxial connectors with a characteristic impedance of 50  $\Omega$ . The main antenna connector supports both Bluetooth and dual-band Wi-Fi. The second (MIMO) antenna connector provides support for 2x2 MIMO 2.4 GHz single band Wi-Fi.

The ODIN-W262 module has an internal dual-band PIFA antenna and supports Bluetooth and dual-band Wi-Fi (SISO).

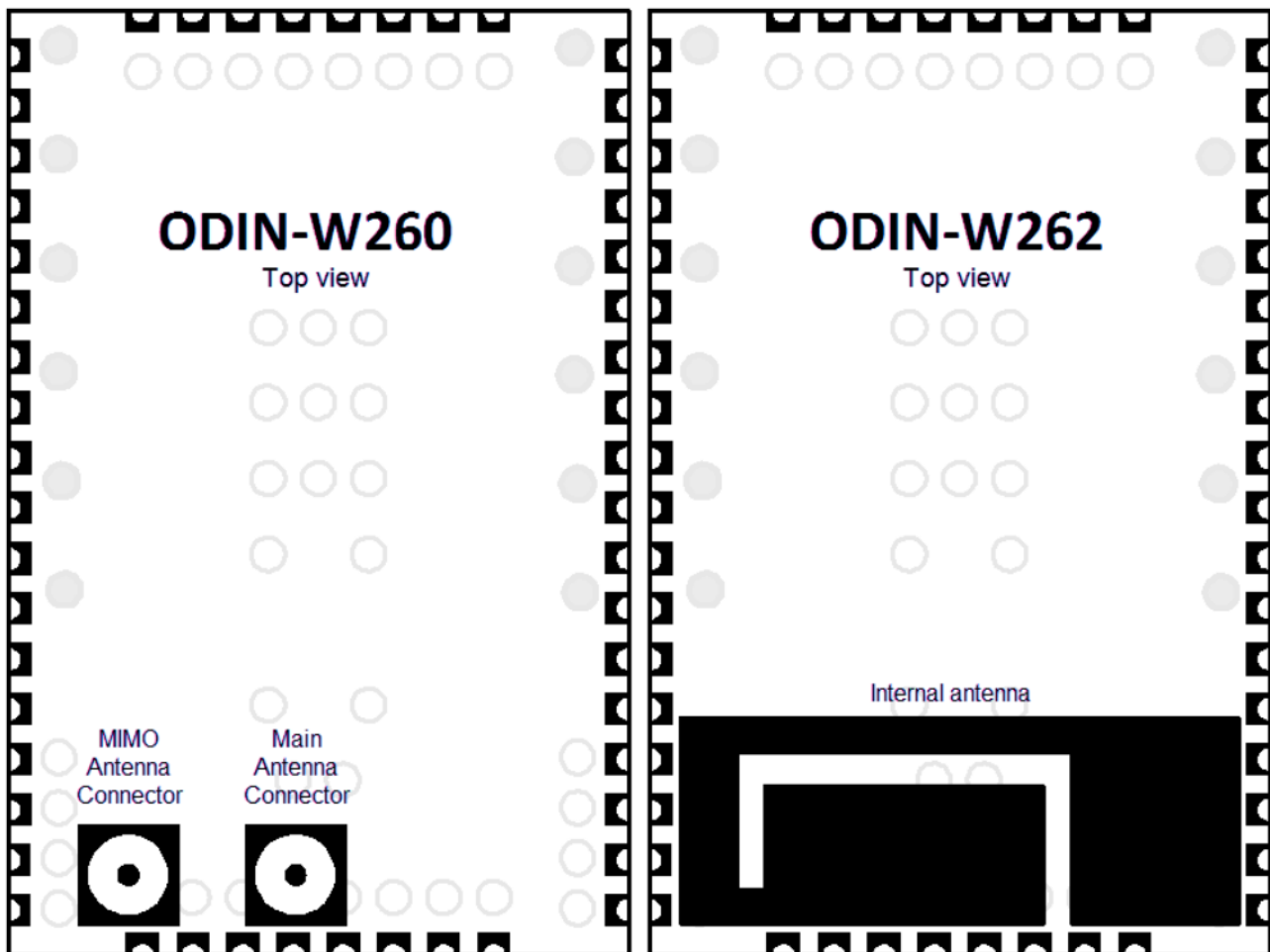

Figure 3: ODIN-W260 with connectors for external antennas and ODIN-W262 with an internal antenna

## 1.9 Configurations options

### 1.9.1 UART selection for virtual COM port

It is possible to select either UART1 or UART3 to be relayed through the onboard debugger as a virtual COM port available at the USB connector.

Depending on the selected UART, the jumpers on header J13 can be configured in two different ways. The default configuration uses UART1 as shown in Figure 4. If you select UART3, configure the two jumpers as shown in Figure 5 .

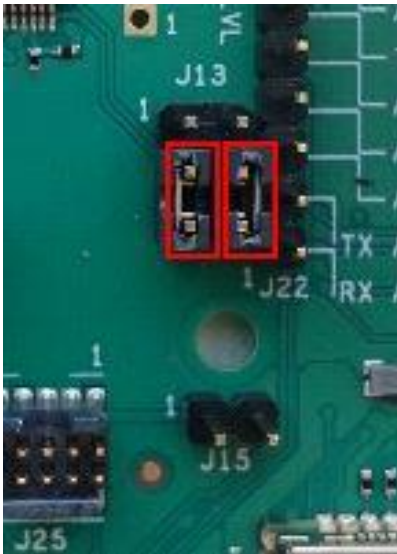

Figure 4 UART1 virtual COM port

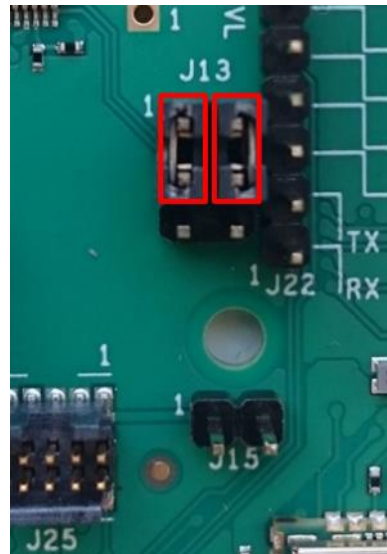

Figure 5: UART3 virtual COM port

### 1.9.2 A1 and A2 analog in vs digital I/O

On the J2 socket connector, there are two pins - A1 and A2 that can be configured either as analog inputs or digital I/Os in the 3.3 V I/O domain. By default, these two pins will be configured as digital I/Os, as shown in Figure 6. To use them as analog inputs, configure the jumpers on pin header J26 as shown in Figure 7. You can also use one pin as analog input and another as digital I/O as long as you configure the jumpers accordingly. The analog level conversion down to the ODIN-W2 1.8 V I/O level is handled by onboard voltage follower op amps.

To use the corresponding pins on the 1.8 V I/O level pin header, J23, remove the jumpers on J26 pin header.





Figure 7: A1 and A2 as digital I/O on J2



Figure 6: A1 and A2 as analog in on J2

🔗 Due to the dual functionality of the A1 and A2 pins, there is a slight degradation of accuracy when using the pins as analog inputs. If you require full accuracy, it is recommended to disable the digital feature permanently by unmounting resistor R81 and R82 as shown in Figure 8.



Figure 8: Resistors R81 and R82

### 1.9.3 ODIN-W2 boot

The boot jumper J15 is used to force the boot mode. This is helpful when the SWD pins have been mistakenly configured as GPIOs and it is no longer possible to communicate with the module.

### 1.9.4 SWD Cortex debug connector

The EVK-ODIN-W2 has an onboard ST-Link v2.1 debugger. You can also connect an external debugger to the ODIN-W2 module via the 10-pin SWD Cortex debug connector J25.

The onboard debugger should be enabled (jumper on position J6 mounted) even if using an external debugger.

## 1.9.5 32.768 kHz LPO oscillator

There is an onboard 32.768 kHz oscillator on the EVK-ODIN-W2. The output signal of this oscillator can be connected to ODIN-W2 by putting a jumper on pin header J21. The LPO is used for the Wi-Fi chip to enable entering low power modes. If the external LPO is not connected, an internal clock will be generated by the MCU on the module. The benefit of using an external LPO is that the MCU on the module can enter the lowest power mode, that is, the stop mode.



Figure 9: 32.768 kHz oscillator and pin header J21

## 2 Getting started

### 2.1 ST-link

The ST-link utility and drivers used by the EVK-ODIN-W2 can be obtained from <http://st.com> (search for STSW-LINK004). Note that registration is required and it can take a few hours before you can download the software.

 You should install the ST-link utility and drivers before connecting the USB cable to your PC.

 There can be some issues while using the EVK-ODIN-W2 with Windows 10. To avoid these issues, upgrade the ST-link firmware on the debug chip and make sure that you have the latest USB mass storage device driver. See Appendix A for additional information.

### 2.2 Power up the evaluation board

To power up the evaluation board, plug in an external power supply in J11 connector or connect to a USB host with a USB cable attached to the J8 connector.

 Be careful to check polarity before connecting the external power supply to the EVK-ODIN-W2 evaluation board. Center conductor is positive (+) and the ring is negative (-).

### 2.3 Getting started with u-connectXpress software

The EVK-ODIN-W2 evaluation board is delivered with u-connectXpress software flashed to the ODIN-W2 module. The UART application can be accessed through the USB connector with the following limitations:

1. No UART flow control
2. Recommended baud rate: 115 200

These limitations are due to the UART being routed through the ST-link debug chip. The virtual comport that is used should present itself as "STMicroelectronics STLink Virtual COM Port". You can check the port number using the Windows Device Manager if you did not observe it during installation.

The default baudrate settings are provided below:

- Baudrate: 115 200
- Data: 8 bit
- Parity: none
- Stop: 1 bit
- Flow control: none

 Notice that the UART setting differs from the default configuration of the ODIN-W2 modules where flow control using CTS and RTS is enabled.

 If the serial settings are reset by holding SW1 during boot, flow control will be enabled again. To communicate with ODIN-W2 after this, disable the flow control again by following the steps 4-7 in section 2.3.2.

For more information about the u-connectXpress application of ODIN-W2, refer to the u-connectXpress software User Guide [5].

### 2.3.1 Usage with UART flow control

To set up the EVK-ODIN-W2 evaluation board for use with the u-blox connectivity software and flow control, see Table 4 for pin description. If you require the USB interface, a Serial to USB FTDI cable can be used on the headers in the 1.8 V I/O domain.

Signal	EVK-ODIN-W2 3.3V I/O	EVK-ODIN-W2 1.8V I/O
GND	J4, GND	J23, GND
CTS	J3, A10	J22, A10
VCC	J1, IOREF	J23, 1V8
TXD	J4, A11	J22, A11
RXD	J3, A13	J22, A13
RTS	J3, A12	J22, A12

Table 4: EVK-ODIN-W2 UART pin description

### 2.3.2 Restore the u-connectXpress software firmware

After downloading an Arm Mbed application, you might want to restore the EVK-ODIN-W2 evaluation board for usage with the u-connectXpress software. To restore the EVK-ODIN-W2 evaluation board, perform the steps mentioned below:

1. To program the bootloader to flash on your EVK-ODIN-W2, just copy the bootloader binary (ODIN-W2-BOOT-v0.8.1.bin or later) to your Mbed USB mass storage device. The bootloader is available in the software package downloaded from the u-blox webpage [3].
2. The Windows application s-center is used to download the application firmware. In s-center “Firmware update dialog”, select mode “Rescue mode (Bootloader)”.
3. After download, reset your EVK-ODIN-W2 device.

The UART settings will be set to default in the ODIN-W2 module, which means that you will not be able to read from the device without using flow control. Since flow control is not supported on the UART provided through the ST-link debug chip on the USB connector, you need to execute the following steps to disable the flow control:

4. Open s-center at baudrate 115200 without flow control enabled.
5. Issue AT command to disable the flow control (AT+UMRS=115200,2,8,1,1,0).
6. Issue AT command to store the settings (AT&W).
7. Reset the device (AT+CPWROFF or button).

 You will not be able to see that the command is accepted, because the flow control is still enabled on the module.

## 2.4 Getting started with Arm® Mbed™

When using the EVK-ODIN-W2 for Mbed development, the USB connector (J8) is used to debug, drag, and drop the firmware flash programming and access the UART.

### 2.4.1 Github

GitHub is a web-based Git repository hosting service. It offers revision control and source code management.

Drivers and example code for Mbed from u-blox are distributed through GitHub. It is recommended to create your own GitHub account, which is free of charge. Go to <https://github.com> and create a normal user account.

In addition to creating a GitHub user account, it is recommended to install a Git command-line tool to manage the Git repositories. Go to <https://git-scm.com/downloads> and follow the installation instructions.

-  Ensure “Use Git from the Windows Command Prompt” is selected in the “Adjusting your PATH environment” step.

## 2.4.2 Mbed OS 3

Yotta is a command-line tool from Arm that provides an offline toolchain for build and development of Mbed applications. Go to <http://yottadocs.mbed.com/> and follow the installation instructions.

Bluetooth and Wi-Fi driver including API documentation is available at:

<https://github.com/u-blox/ublox-odin-w2-drivers-binary>

Example applications for using the Bluetooth and Wi-Fi driver can be found at:

<https://github.com/u-blox/mbed-examples-odin-w2>

### 2.4.2.1 Licenses

In your Arm Mbed application, licenses of each integrated module must be considered. The Permissive Binary License applies for u-blox binary deliverables of Bluetooth and Wi-Fi driver. The permissive binary license is available at <https://github.com/u-blox/ublox-odin-w2-drivers-binary/blob/master/permissive-binary-license-1.1-for-u-blox-odin-w2-drivers.txt>

For other modules, see the respective license in the github archive of the module.

## 2.4.3 Mbed OS 5

Mbed CLI is the name of the Arm Mbed command line tool, which enables the full Mbed workflow: repositories version control, maintaining dependencies, updating from remotely hosted repositories (GitHub, GitLab and mbed.org), and invoking Arm Mbed's own build system. The document <https://github.com/ARMmbed/mbed-cli#introduction> covers the installation and usage of Mbed CLI.

Wi-Fi driver documentation is available at:

<https://github.com/u-blox/ublox-odin-w2-drivers-docs-mbed-5>

Example application for using the Wi-Fi driver can be found at:

<https://github.com/ARMmbed/mbed-os-example-wifi>

For Bluetooth low energy support, the Cordio stack by Arm is used. For more details and examples see [Cordio Bluetooth low energy](#).

-  Note that Bluetooth BR/EDR is not supported on ODIN-W2 in Mbed OS 5.

### 2.4.3.1 Licenses

In your Arm Mbed application, licenses of each integrated module must be considered. The Permissive Binary License applies for u-blox binary deliverables of Bluetooth and Wi-Fi driver. The permissive binary license is available at:

[https://github.com/ARMmbed/mbed-os/blob/master/targets/TARGET\\_STM/TARGET\\_STM32F4/TARGET\\_UBLOX\\_EVK\\_ODIN\\_W2/sdk/LICENSE-permissive-binary-license-1.0.txt](https://github.com/ARMmbed/mbed-os/blob/master/targets/TARGET_STM/TARGET_STM32F4/TARGET_UBLOX_EVK_ODIN_W2/sdk/LICENSE-permissive-binary-license-1.0.txt)

For other modules, see the respective license in the github archive of the module.

## Appendix

# A Updating the ST-link software

Due to an incompatibility between the ST-link software in the debug chip and Windows 10, the EVKs produced before December 01, 2016 will not work with Windows 10. Connecting them to a PC running Windows 10 will corrupt the bootloader of ODIN-W2 and the EVK will stop working. Also, the latest EVKs might have issues with flashing if the USB mass storage device driver is not up to date.

## A.1 Repairing an older board already connected to a Windows 10 PC

To fix this issue, the bootloader of ODIN-W2 must be reflashed. To reflash the bootloader, follow step 1 mentioned in section 2.3.2.

## A.2 Updating the ST-link firmware of the debug chip

To update the ST-link firmware, do the following:

1. Download the following application from ST  
[http://www.st.com/content/st\\_com/en/products/embedded-software/development-tool-software/stsw-link007.html](http://www.st.com/content/st_com/en/products/embedded-software/development-tool-software/stsw-link007.html)

 Note that the drivers are bundled with the ST-LinkUpgrade file so the latest file can be downloaded.

2. Run the executable *ST-LinkUpgrade.exe*.
3. Press Device Connect as shown in the screenshot below and the current Firmware version will be shown. The firmware should be upgraded to the version - V2.J32.M22 at least as shown in the screenshot below.

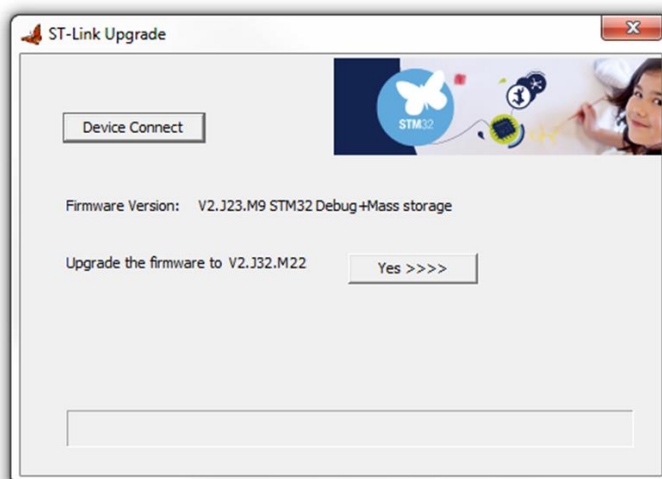

4. Click **Yes** and wait for the update to complete.

### A.2.1 Upgrading the USB mass storage device driver

Make sure that the computer has the latest USB mass storage device driver (10.0.17134.1 or later). If it is not possible to upgrade the driver to the correct version, disable the driver to avoid this issue.

# B Schematic



Top

Bottom

Figure 10: Placement on EVK-ODIN-W2

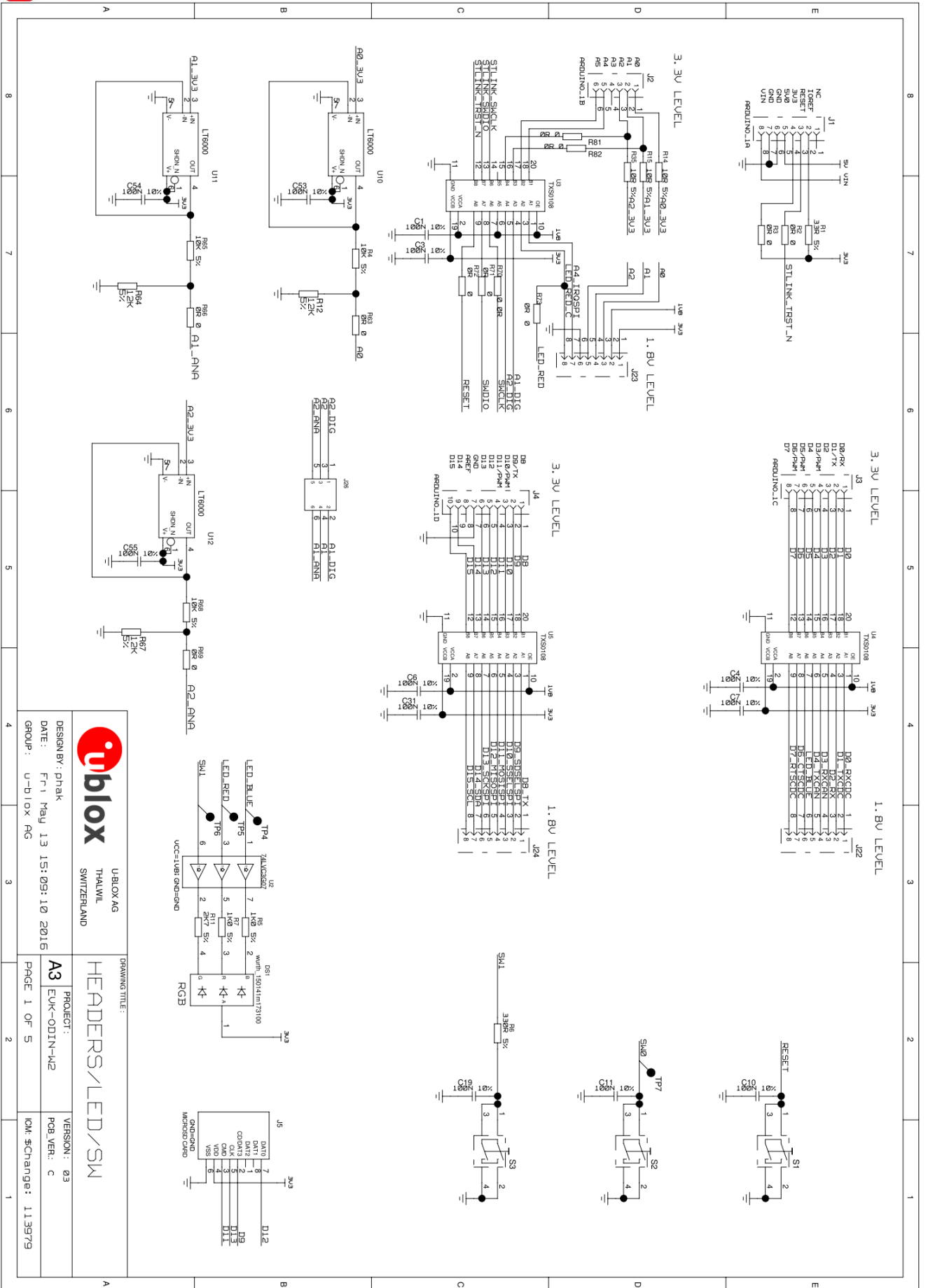



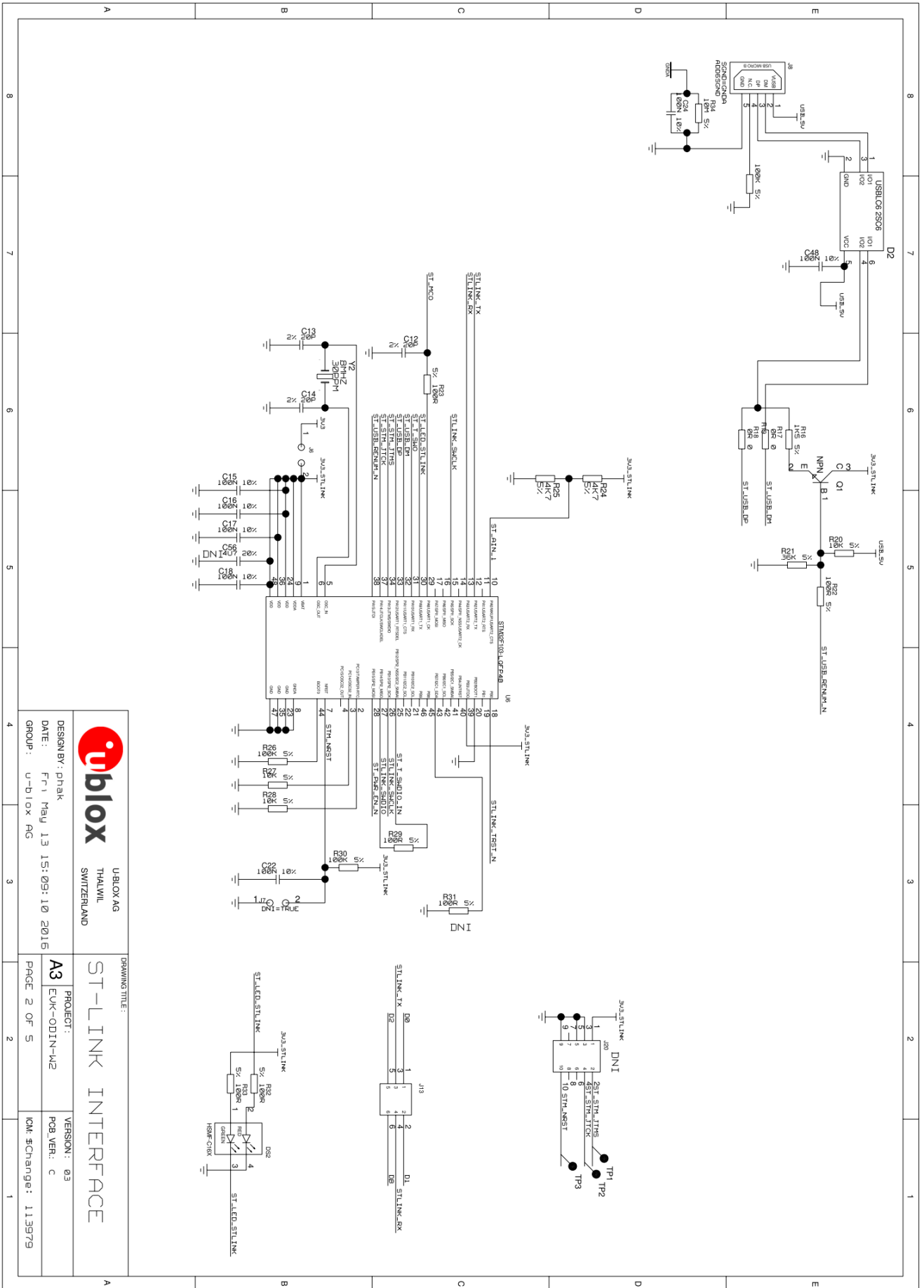

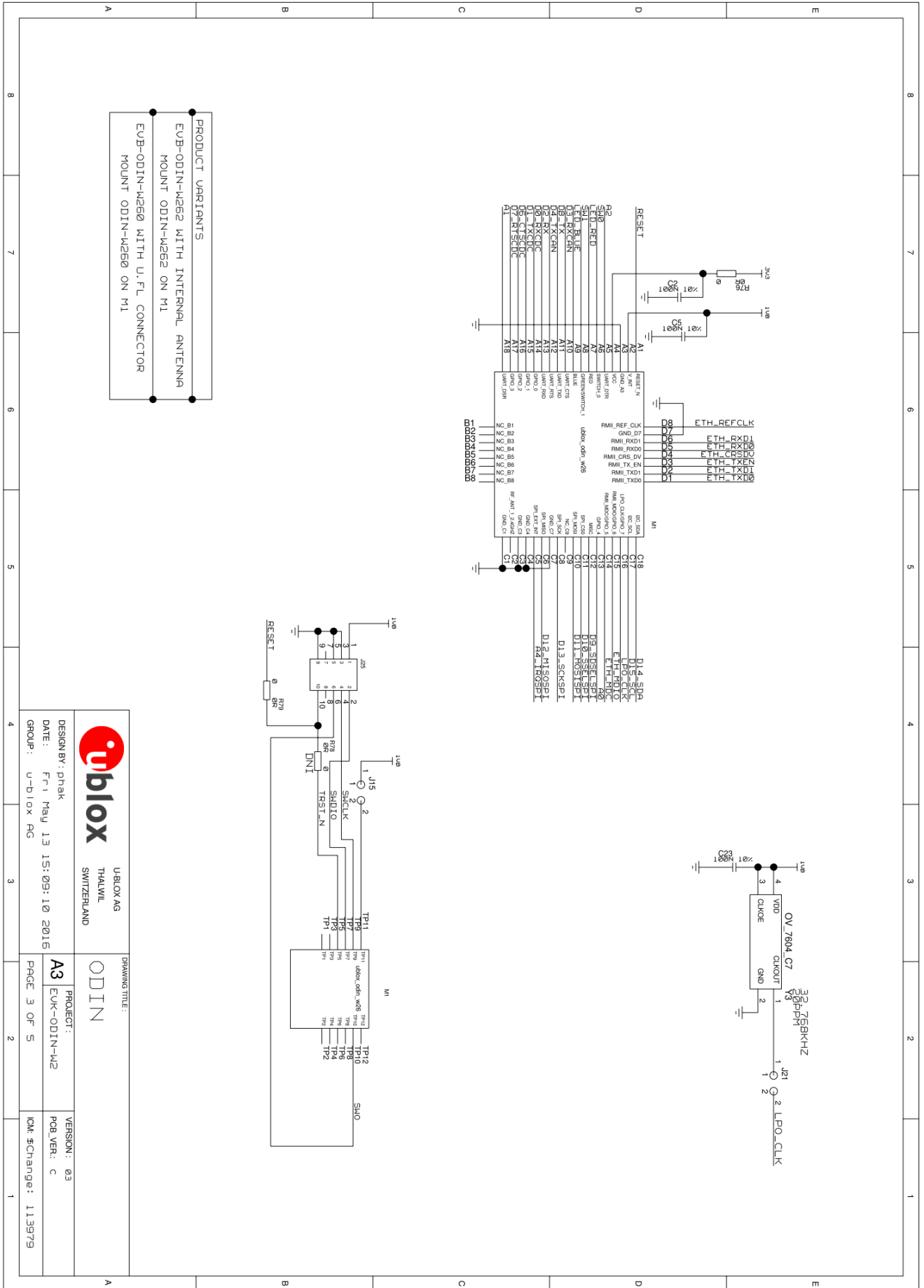

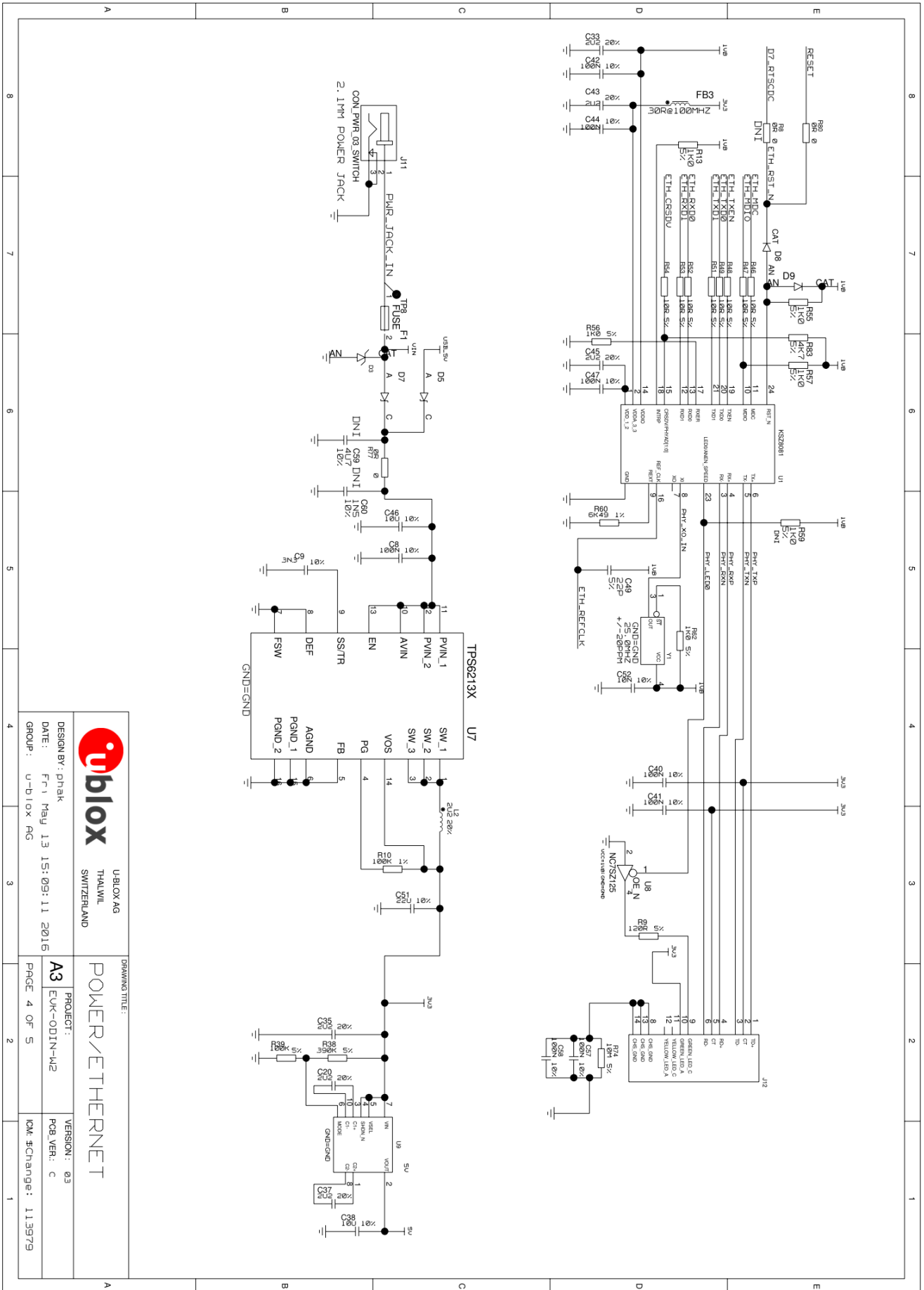

		UBLIX AG THALWIL SWITZERLAND	
DESIGN BY: Dhak DATE: Fri May 13 15:09:11 2016 GROUP: ublox RG		DRAWING TITLE: <b>POWER/ETHERNET</b>	
PROJECT: EVK-ODIN-W2		VERSION: 03 PCB VER: C	
PAGE 4 OF 5		ICM-#Change: 113979	

## C Glossary

Name	Definition
COM	Communication
CTS	Clear to send
EDR	Enhanced data rate
EVK	Evaluation kit
GND	Ground
GPIO	General-Purpose Input/Output
LED	Light-Emitting Diode
LPO	Low power oscillator
MCU	Multipoint control unit
MIMO	Multiple input multiple output
PIFA	Planar Inverted-F Antenna
PHY	Physical layer (of the OSI model)
RMII	Reduced media-independent interface
RTS	Request to send
SISO	Single input single output
SPA	Serial port application
SWD	Serial wire debug
UART	Universal Asynchronous Receiver/Transmitter
UMRS	Universal microfilm reader scanner
USB	Universal serial bus
VCC	IC power-supply pin

**Table 6: Explanation of abbreviations used**

## Related documents

- [1] ODIN-W2 series System integration manual, Doc. No. [UBX-14040040](#)
- [2] ODIN-W2 series in Arm® Mbed™ environment system integration manual – Mbed addendum, Doc. No. [UBX-16008405](#)
- [3] ODIN-W2 Online resources <https://www.u-blox.com/en/product/odin-w2-series>
- [4] ODIN-W2 series data sheet, Doc. No. [UBX-14039949](#)
- [5] u-connectXpress software user guide, Doc. No. [UBX-16024251](#)

 For regular updates to u-blox documentation and to receive product change notifications, register on our homepage ([www.u-blox.com](http://www.u-blox.com)).

## Revision history

Revision	Date	Name	Comments
R01	4-May-2016	mhan, kgom	Initial release.
R02	8-July-2016	apet, kgom	Added information in A1 and A2 analog in vs digital I/O (section 1.9.2). Added licenses information (section 2.4.2.1). Updated connectors and pin assignment figure (Figure 2). Minor updates in sections 1.9.3 and 2.3.
R03	13-Dec-2016	apet, fbro, kgom	Added antenna information. Added mbed OS 5 to Getting started with mbed. Added information on incompatibility with Windows10 and warning on serial port settings. Added Appendix A - ST-link update and Appendix B - Schematic. In the Document Information table on page 2, replaced "Status" ("Early Production Information") with "Disclosure restriction"; also removed Document status explanation table on page 2.
R04	26-May-2017	kgom	Minor updates.
R05	23-Aug-2017	kgom	Minor changes based on the latest brand guidelines of Arm Mbed.
R06	26-Mar-2019	fbro, kgom	Added information about incompatibility with Windows10 in Appendix A.
R07	6-Sep-2019	mhan	Replaced "u-blox connectivity software" with "u-connectXpress software" in all instances. Improved LEDs description (section 1.4). Replaced reference to the obsolete Getting Started document with u-connectXpress software User Guide (section 2.3). Added note that Bluetooth BR/EDR is not supported in Mbed OS 5 (section 2.4.3).