

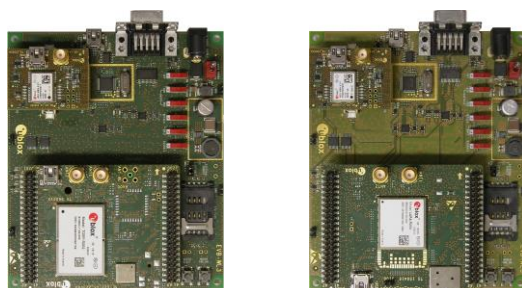

EVK-R2

TOBY-R2 and LARA-R2 series Cellular Evaluation Kits

User Guide



Abstract

This guide explains how to set up the EVK-R2 Evaluation Kits to begin evaluating the u-blox TOBY-R2 and/or LARA-R2 series cellular modules supporting LTE Cat 1 / 3G / 2G radio access technologies.

Document Information

| | | |
|--------------------------|---|-------------|
| Title | EVK-R2 | |
| Subtitle | TOBY-R2 and LARA-R2 series Cellular Evaluation Kits | |
| Document type | User Guide | |
| Document number | UBX-16016088 | |
| Revision and date | R10 | 01-Jul-2019 |

Disclosure Restriction

| Product status | Corresponding content status | |
|-------------------------------|-------------------------------------|--|
| Functional Sample | Draft | For functional testing. Revised and supplementary data will be published later. |
| In Development / Prototype | Objective Specification | Target values. Revised and supplementary data will be published later. |
| Engineering Sample | Advance Information | Data based on early testing. Revised and supplementary data will be published later. |
| Initial Production | Early Production Information | Data from product verification. Revised and supplementary data may be published later. |
| Mass Production / End of Life | Production Information | Document contains the final product specification. |

This document applies to the following products:

| Product name | Type number | Modem version | Application version | PCN reference | Product status |
|---------------------|--------------------|----------------------|----------------------------|----------------------|-----------------------|
| EVK-R200 | EVK-R200-00B-00 | 30.31 | A01.01 | UBX-17006265 | Mass Production |
| EVK-R202 | EVK-R202-00B-00 | 30.31 | A01.01 | UBX-17006265 | Mass Production |
| EVK-R203 | EVK-R203-00B-00 | 30.39 | A01.00 | UBX-17048311 | Mass Production |
| EVK-R204 | EVK-R204-00B-00 | 31.34 | A01.00 | UBX-17012269 | Mass Production |
| EVK-R211 | EVK-R211-00B-00 | 30.31 | A01.00 | UBX-17012270 | Mass Production |
| EVK-R220 | EVK-R220-00B-00 | 30.43 | A01.01 | UBX-17061668 | Mass Production |
| EVK-R280 | EVK-R280-00B-00 | 30.43 | A01.01 | UBX-17063950 | Mass Production |

u-blox or third parties may hold intellectual property rights in the products, names, logos and designs included in this document. Copying, reproduction, modification or disclosure to third parties of this document or any part thereof is only permitted with the express written permission of u-blox.

The information contained herein is provided "as is" and u-blox assumes no liability for its use. No warranty, either express or implied, is given, including but not limited to, with respect to the accuracy, correctness, reliability and fitness for a particular purpose of the information. This document may be revised by u-blox at any time without notice. For the most recent documents, visit www.u-blox.com.

Copyright © u-blox AG.

Contents

| | |
|--|-----------|
| Document Information | 2 |
| Contents | 3 |
| 1 Starting up | 4 |
| 1.1 EVK-R2 overview | 4 |
| 1.2 EVK-R2 block diagram | 7 |
| 1.3 Switches, jumpers and buttons | 8 |
| 1.4 LEDs..... | 8 |
| 1.5 Connectors | 9 |
| 1.6 EVK-R2 pin out..... | 10 |
| 1.6.1 EVK-R2 for TOBY-R2 series modules | 10 |
| 1.6.2 EVK-R2 for LARA-R2 series modules | 12 |
| 1.7 Software installation | 13 |
| 1.8 Board setup | 13 |
| 1.9 Enabling error result codes | 15 |
| 1.10 PIN code insertion (when required)..... | 15 |
| 1.11 Registration on a cellular network..... | 16 |
| 1.12 Enable audio codec configuration to provide voice capability | 16 |
| 1.13 Switching off the EVK-R2..... | 16 |
| Appendix | 17 |
| A Setting up AT terminal applications for communication with EVK-R2 | 17 |
| B Setting up cellular packet data connection on PC | 18 |
| B.1 How to install and configure a low data rate modem connection | 18 |
| B.2 How to install and configure a high data rate modem connection | 21 |
| C Examples of AT commands | 23 |
| C.1 Define the initial default bearer for connectivity | 23 |
| D Current consumption measurement | 24 |
| E Glossary | 25 |
| F Declaration of conformities | 25 |
| Related documents | 26 |
| Revision history | 26 |
| Contact | 27 |

1 Starting up

1.1 EVK-R2 overview

The EVK-R2 kits are powerful and easy-to-use tools that simplify the evaluation of u-blox TOBY-R2 and LARA-R2 series multimode LTE Cat 1 / 3G / 2G cellular modules.

The following evaluation kits are available with u-blox TOBY-R2 cellular modules (see [Figure 1](#)):

- EVK-R200 evaluation kit is for evaluation of TOBY-R200
- EVK-R202 evaluation kit is for evaluation of TOBY-R202

The following evaluation kits are available with u-blox LARA-R2 cellular modules (see [Figure 2](#)):

- EVK-R203 evaluation kit is for evaluation of LARA-R203
- EVK-R204 evaluation kit is for evaluation of LARA-R204
- EVK-R211 evaluation kit is for evaluation of LARA-R211
- EVK-R220 evaluation kit is for evaluation of LARA-R220
- EVK-R280 evaluation kit is for evaluation of LARA-R280

All the EVK-R200, EVK-R202, EVK-R203, EVK-R204, EVK-R211, EVK-R220, EVK-R280 evaluation kits are herein identified as EVK-R2.

 See the TOBY-R2 series Data Sheet [\[3\]](#), LARA-R2 series Data Sheet [\[4\]](#), TOBY-R2 series System Integration Manual [\[5\]](#) and LARA-R2 series System Integration Manual [\[6\]](#) for the features supported by the u-blox TOBY-R2 and LARA-R2 series cellular modules.

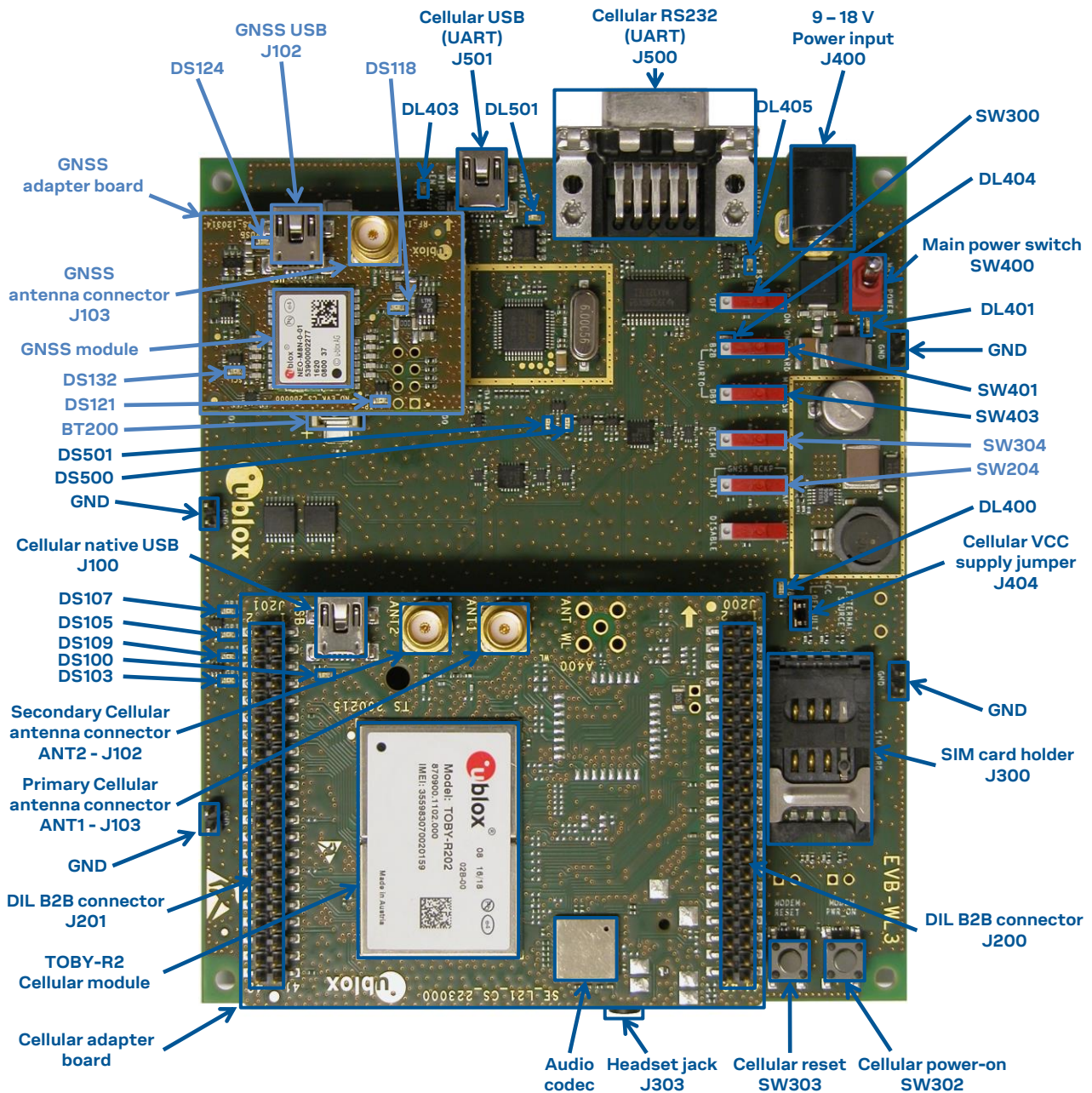

Figure 1: Overview of EVK-R2 evaluation kit for TOBY-R2 modules

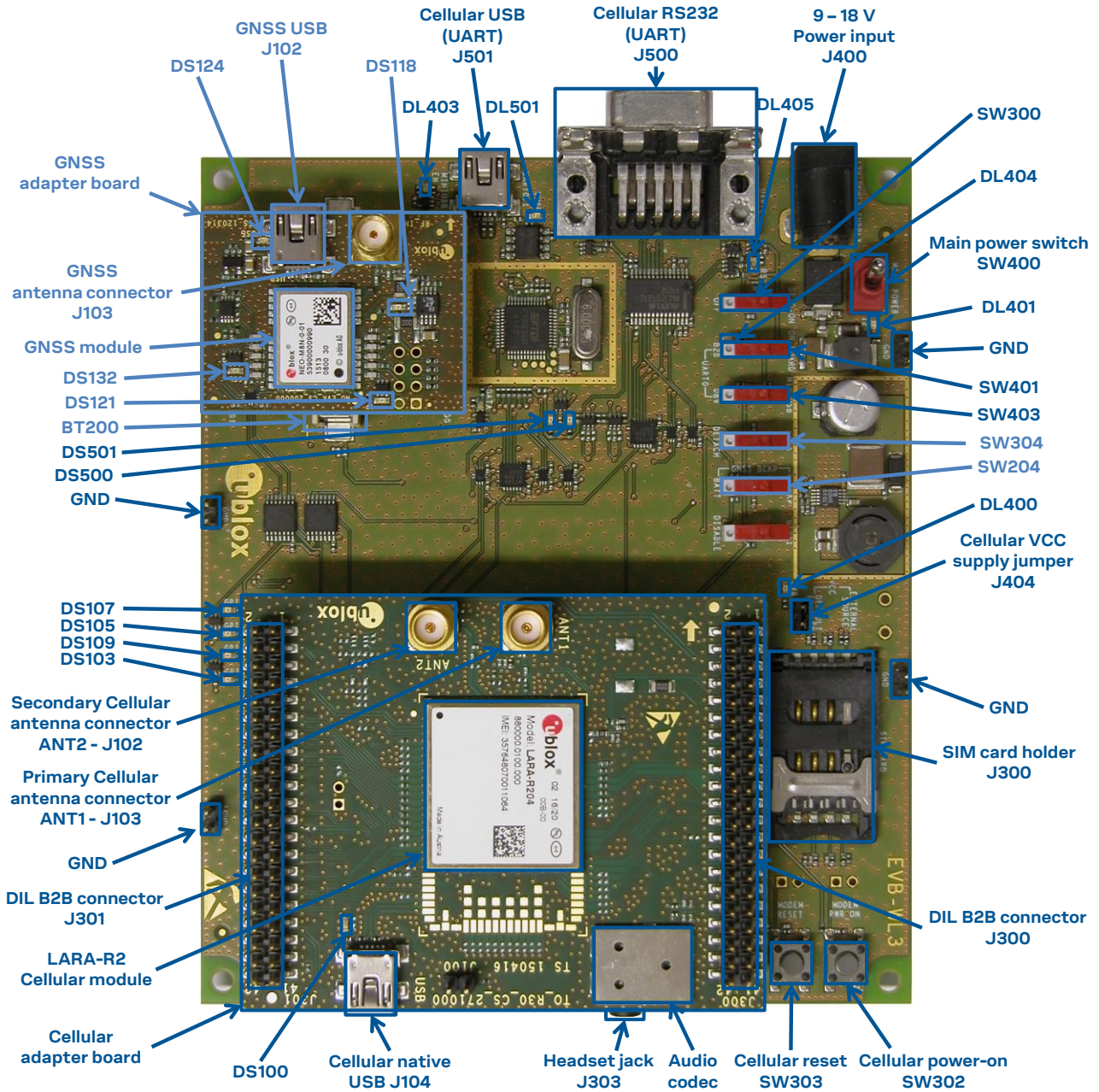

Figure 2: Overview of EVK-R2 evaluation kit for LARA-R2 modules

1.2 EVK-R2 block diagram

Figure 3 shows the main interfaces and internal connections of the EVK-R2 evaluation kit:

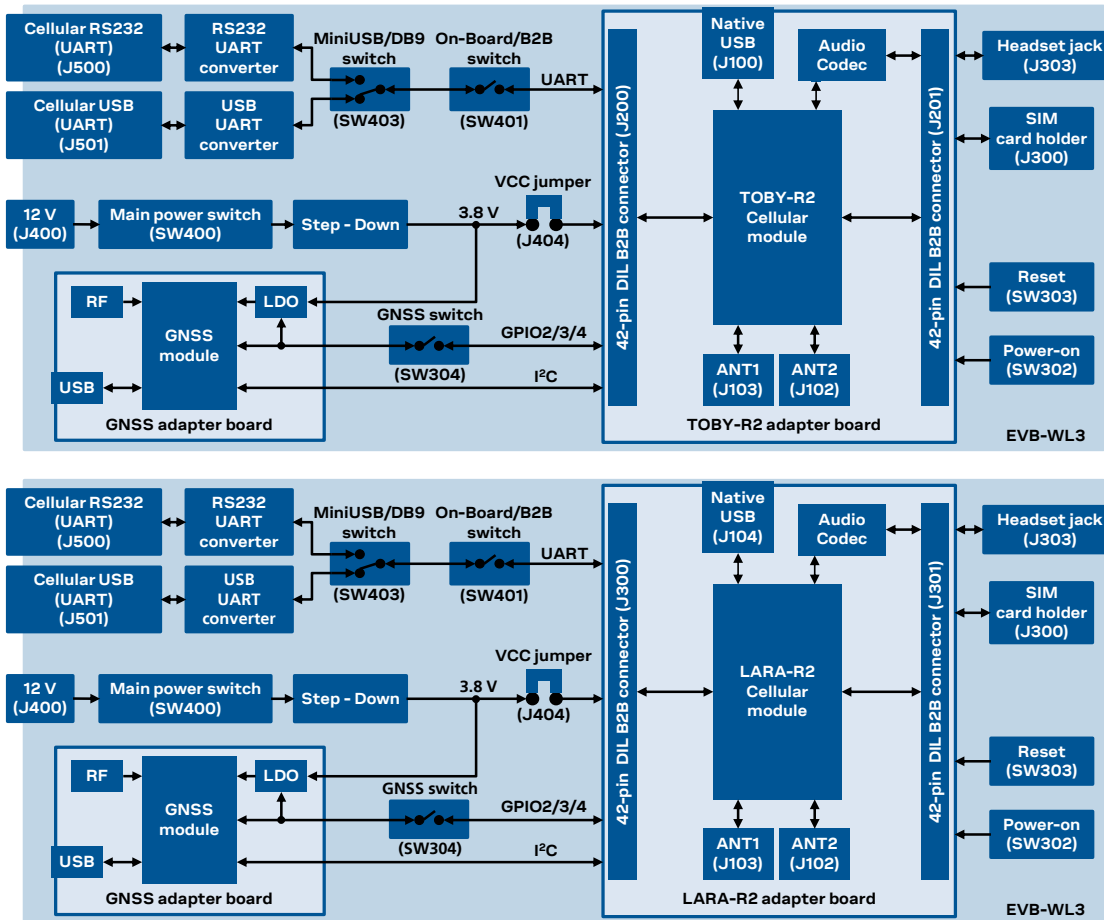

Figure 3: Block diagram of EVK-R2 for TOBY-R2 modules (shown on top) and LARA-R2 modules (shown on bottom)

The EVK-R2 is formed by three boards:

- The lower one, called EVB-WL3, contains the power supply and other peripherals for the TOBY-R2 series or the LARA-R2 series cellular module (SIM card holder, Reset button and Power-on button).
- The cellular adapter board, called ADP-R2, contains the TOBY-R2 or LARA-R2 cellular module, the cellular antenna connectors, the USB connector for the cellular module, and an audio codec.
- The GNSS adapter board, called ADP-GNSS, contains the u-blox GNSS module, the GNSS antenna connector and the USB connector for the GNSS module.

The boards are connected by means of male header board-to-board connectors provided on the bottom of the adapter boards and their corresponding female connectors provided on the top of the lower board.

The USB interface of the cellular module is available on the native USB connector on the cellular adapter board, while the other peripherals are available on the Dual-In-Line male Board-to-Board connectors provided on the top layer of the cellular Adapter Board (J200 / J201 or J300 / J301), which are pin-to-pin compatible to the connectors on the bottom layer of the adapter board.

The lower board (EVB-WL3) is designed to also be used with other u-blox cellular adapter boards. It contains additional switches, jumpers, connectors, LEDs and parts that are partially described in Figure 1/ Figure 2 or in this document, because they are intended for use only with other u-blox cellular modules. It is recommended to leave any additional connector unconnected, and to leave any additional switch in its default configuration.

1.3 Switches, jumpers and buttons

| Function | Description | Name | Board |
|-----------------------|--|-------|-------|
| Main Power Switch | Power on / off of the whole evaluation kit | SW400 | EVB |
| Cellular VCC | Jumper socket to provide the 3.8 V supply to the cellular module VCC input | J404 | EVB |
| Cellular Power-on | Push button to switch-on the cellular module | SW302 | EVB |
| Cellular Reset | Push button to reset the cellular module | SW303 | EVB |
| Cellular UART detach | Slide switch to attach / detach cellular module UART from USB / RS232 connectors: when detached, UART signals available only on DIL B2B connector on ADP board | SW401 | EVB |
| Cellular UART routing | Slide switch to select cellular module UART routing on USB or on RS232 connector | SW403 | EVB |
| Cellular GPIO detach | Slide switch to attach / detach the cellular module GPIOs, SIM_DET from peripherals: when detached, the signals are available only on the DIL B2B connector on ADP board | SW300 | EVB |
| Cellular GNSS detach | Slide switch to attach / detach the cellular module to the GNSS module (GPIO2-3-4): when detached, the signals are available only on DIL B2B connector on ADP board | SW304 | EVB |
| GNSS V_BCKP | Slide switch to connect / disconnect backup battery to V_BCKP pin of the GNSS module | SW204 | EVB |

Table 1: EVK-R2 switch and button descriptions

1.4 LEDs

















| Function | Description | LED # | Board | Color |
|--------------------------|--|-------|----------|---|
| Main Power | Power supply plugged in the 9 - 18 V Power Input | DL401 | EVB |  |
| Cellular VCC | Cellular module supplied. Main Power Switch must be switched on | DL400 | EVB |  |
| Cellular native USB | USB cable plugged in the Cellular native USB connector | DS100 | ADP-R2 |  |
| Cellular USB | USB cable plugged in the Cellular USB connector for UART access | DL501 | EVB |  |
| Cellular USB / UART | Green light is activated when UART is routed to the Cellular USB connector Red light blinks at UART TX or RX data on the Cellular USB connector | DL403 | EVB |  |
| Cellular UART detach | UART signals are available only on the DIL B2B connector on ADP board | DL404 | EVB |  |
| Cellular RS232 / UART | Green light is activated when UART is routed to Cellular RS232 connector Red light blinks at UART TX or RX data on the Cellular RS232 connector | DL405 | EVB |  |
| Cellular RI indicator | RI line turns ON (active low) | DS501 | EVB |  |
| Cellular CTS indicator | CTS line turns ON (active low) | DS500 | EVB |  |
| Cellular GPIO1 indicator | Green light is activated when cellular GPIO1 is high | DS107 | EVB |  |
| Cellular GPIO2 indicator | Green light is activated when cellular GPIO2 is high | DS105 | EVB |  |
| Cellular GPIO3 indicator | Green light is activated when cellular GPIO3 is high | DS109 | EVB |  |
| Cellular GPIO4 indicator | Green light is activated when cellular GPIO4 is high | DS103 | EVB |  |
| GNSS VCC supply | GNSS module supply is turned ON | DS118 | ADP-GNSS |  |
| GNSS USB | USB cable plugged in GNSS USB connector | DS124 | ADP-GNSS |  |
| GNSS Timepulse | Pulses at 1 Hz when valid GNSS fix | DS121 | ADP-GNSS |  |
| Cellular / GNSS DDC | Cellular / GNSS module communication over the DDC (I ² C) interface | DS132 | ADP-GNSS |  |

Table 2: EVK-R2 LED descriptions

1.5 Connectors



| Function | Description | Name | Board |
|----------------------------|--|--|----------|
| 9 - 18 V Power Input | Connector for the AC / DC power adapter of the EVK  IEC 60417-5172 Class II equipment | J400 | EVB |
| SIM card holder | SIM card holder | J300 | EVB |
| Primary cellular antenna | SMA connector for the cellular module primary antenna (ANT1, Tx/Rx) | J103 | ADP-R2 |
| Secondary cellular antenna | SMA connector for the cellular module secondary antenna (ANT2, Rx) | J102 | ADP-R2 |
| Cellular native USB | Mini USB connector for the cellular module native USB interface | J100 ¹ J104 ² | ADP-R2 |
| Cellular USB (UART) | Mini USB connector for the cellular module UART interface converted as USB interface | J501 | EVB |
| Cellular RS232 (UART) | DB9 connector for the cellular module UART interface converted as RS232 interface | J500 | EVB |
| DIL B2B headers | Dual-In-Line Board-to-Board connectors for cellular module interfaces | J200-J201 ¹ J300-J301 ² | ADP-R2 |
| Cellular headset | Audio headset jack connector for the cellular module audio interface | J303 | EVB |
| GNSS antenna | SMA connector for the GNSS module antenna (GNSS antenna) | J208 | ADP-GNSS |
| GNSS USB | Mini USB connector for the GNSS module USB interface | J102 | ADP-GNSS |
| GNSS backup battery | Backup battery socket for the GNSS module (under GNSS adapter board) | BT200 | EVB |
| GND | Ground terminals for the probe reference | J402, J403 J405, J406 | EVB |

Table 3: EVK-R2 connector descriptions

-  CAUTION! IN THE UNLIKELY EVENT OF A FAILURE IN THE INTERNAL PROTECTION CIRCUITRY, THERE IS A RISK OF AN EXPLOSION WHEN CHARGING A FULLY OR PARTIALLY DISCHARGED BATTERY. REPLACE THE BATTERY WHEN IT NO LONGER HAS A SUFFICIENT CHARGE FOR UNIT OPERATION. CONTROL THE BATTERY BEFORE USE IF THE DEVICE HAS NOT BEEN USED FOR AN EXTENDED PERIOD OF TIME.
-  CAUTION! RISK OF EXPLOSION IF BATTERY IS REPLACED WITH AN INCORRECT TYPE. DISPOSE OF USED BATTERIES ACCORDING TO THE INSTRUCTIONS!

¹ EVK-R2xx evaluation kit for TOBY-R2 series modules

² EVK-R2xx evaluation kit for LARA-R2 series modules

1.6 EVK-R2 pin out

1.6.1 EVK-R2 for TOBY-R2 series modules

| TOBY-R2 series | | DIL B2B | TOBY-R2 series | | DIL B2B | TOBY-R2 series | | DIL B2B |
|----------------|------------------|----------------|----------------|------------------|--------------------------|----------------|----------|--------------------------|
| Pin N° | Name | Name / Pin N° | Pin N° | Name | Name / Pin N° | Pin N° | Name | Name / Pin N° |
| 1 | RSVD | Not present | 32 | GND | J201 Pins 7-10 | 63 | SDIO_D2 | Not present ³ |
| 2 | GND | J201 Pins 7-10 | 33 | RSVD | Not present | 64 | SDIO_CLK | Not present ³ |
| 3 | V_BCKP | J201 Pin 3 | 34 | RSVD | Not present | 65 | SDIO_CMD | Not present ³ |
| 4 | VUSB_DET | Not present | 35 | RSVD | Not present | 66 | SDIO_D0 | Not present ³ |
| 5 | V_INT | J201 Pin 36 | 36 | RSVD | Not present | 67 | SDIO_D3 | Not present ³ |
| 6 | RSVD | Not present | 37 | RSVD | Not present | 68 | SDIO_D1 | Not present ³ |
| 7 | RSVD | Not present | 38 | RSVD | Not present | 69 | GND | J201 Pins 7-10 |
| 8 | RSVD | Not present | 39 | RSVD | Not present | 70 | VCC | J200 Pins 7-10 |
| 9 | RSVD | Not present | 40 | RSVD | Not present | 71 | VCC | J200 Pins 7-10 |
| 10 | DSR | J201 Pin 18 | 41 | RSVD | Not present | 72 | VCC | J200 Pins 7-10 |
| 11 | RI | J201 Pin 17 | 42 | RSVD | Not present | 73 | GND | J201 Pins 7-10 |
| 12 | DCD | J201 Pin 11 | 43 | RSVD | Not present | 74 | GND | J201 Pins 7-10 |
| 13 | DTR | J201 Pin 12 | 44 | GND | J201 Pins 7-10 | 75 | ANT_DET | Not present |
| 14 | RTS | J201 Pin 13 | 45 | RSVD | Not present | 76 | GND | J201 Pins 7-10 |
| 15 | CTS | J201 Pin 14 | 46 | GND | J201 Pins 7-10 | 77 | RSVD | Not present |
| 16 | TXD | J201 Pin 15 | 47 | RSVD | Not present | 78 | GND | J201 Pins 7-10 |
| 17 | RXD | J201 Pin 16 | 48 | RSVD | Not present | 79 | GND | J201 Pins 7-10 |
| 18 | RSVD | Not present | 49 | RSVD | Not present | 80 | GND | J201 Pins 7-10 |
| 19 | RSVD | Not present | 50 | I2S_WA | Not present ³ | 81 | ANT1 | Not present |
| 20 | PWR_ON | J201 Pin 29 | 51 | I2S_TXD | Not present ³ | 82 | GND | J201 Pins 7-10 |
| 21 | GPIO1 | J201 Pin 33 | 52 | I2S_CLK | Not present ³ | 83 | GND | J201 Pins 7-10 |
| 22 | GPIO2 | J201 Pin 31 | 53 | I2S_RXD | Not present ³ | 84 | RSVD | Not present |
| 23 | RESET_N | J200 Pin 26 | 54 | SCL | J200 Pin 20 | 85 | GND | J201 Pins 7-10 |
| 24 | GPIO3 | J201 Pin 32 | 55 | SDA | J200 Pin 21 | 86 | GND | J201 Pins 7-10 |
| 25 | GPIO4 | J201 Pin 25 | 56 | SIM_CLK | J200 Pin 15 | 87 | ANT2 | Not present |
| 26 | HOST_SELECT 0 | J201 Pin 2 | 57 | SIM_IO | J200 Pin 14 | 88 | GND | J201 Pins 7-10 |
| 27 | USB_D- | Not present | 58 | SIM_RST | J200 Pin 16 | 89 | GND | J201 Pins 7-10 |
| 28 | USB_D+ | Not present | 59 | VSIM | J200 Pin 13 | 90 | GND | J201 Pins 7-10 |
| 29 | RSVD | Not present | 60 | GPIO5 | J201 Pin 23 | 91 | RSVD | Not present |
| 30 | GND | J201 Pins 7-10 | 61 | GPIO6 | Not present ³ | 92 | GND | J201 Pins 7-10 |
| 31 | RSVD | Not present | 62 | HOST_SELEC T1 | J201 Pin 4 | 93-152 | GND | J201 Pins 7-10 |

Table 4: Interfaces of TOBY-R2 series modules, as routed on the 42-pin Dual-In-Line Board-to-Board connectors (J200, J201) available on the adapter board ADP-R2 of the EVK-R2 evaluation kit

³ OR jumper can be populated in order to route the signal to the 42-pin Dual-In-Line Board-to-Board connectors

| DIL B2B J201 | | | DIL B2B J200 | | | | |
|---------------|--------|--------|---------------|---------------|--------|--------|---------------|
| Signal Name | Pin N° | Pin N° | Signal Name | Signal Name | Pin N° | Pin N° | Signal Name |
| HOST_SELECT0 | 2 | 1 | GND | Not connected | 2 | 1 | GND |
| Not connected | 4 | 3 | V_BCKP | Not connected | 4 | 3 | Not connected |
| Not connected | 6 | 5 | Not connected | Not connected | 6 | 5 | Not connected |
| GND | 8 | 7 | GND | VCC | 8 | 7 | VCC |
| GND | 10 | 9 | GND | VCC | 10 | 9 | VCC |
| DTR | 12 | 11 | DCD | Not connected | 12 | 11 | Not connected |
| CTS | 14 | 13 | RTS | SIM_IO | 14 | 13 | VSIM |
| RXD | 16 | 15 | TXD | SIM_RST | 16 | 15 | SIM_CLK |
| DSR | 18 | 17 | RI | Not connected | 18 | 17 | Not connected |
| Not connected | 20 | 19 | Not connected | SCL | 20 | 19 | Not connected |
| Not connected | 22 | 21 | Not connected | Not connected | 22 | 21 | SDA |
| Not connected | 24 | 23 | GPIO5 | Not connected | 24 | 23 | Not connected |
| Not connected | 26 | 25 | GPIO4 | RESET_N | 26 | 25 | Not connected |
| Not connected | 28 | 27 | Not connected | MIC_BIAS | 28 | 27 | MIC_GND |
| Not connected | 30 | 29 | PWR_ON | Not connected | 30 | 29 | Not connected |
| GPIO3 | 32 | 31 | GPIO2 | Not connected | 32 | 31 | Not connected |
| HOST_SELECT1 | 34 | 33 | GPIO1 | SPK_N | 34 | 33 | SPK_P |
| V_INT | 36 | 35 | Not connected | Not connected | 36 | 35 | Not connected |
| Not connected | 38 | 37 | Not connected | Not connected | 38 | 37 | Not connected |
| Not connected | 40 | 39 | Not connected | Not connected | 40 | 39 | Not connected |
| GND | 42 | 41 | GND | GND | 42 | 41 | Not connected |

Table 5: Pin-out of the 42-pin Dual-In-Line Board-to-Board connectors (J201, J200) available on the adapter board ADP-R2 of the EVK-R2 evaluation kit for TOBY-R2 series modules

 The pins / interfaces that are not supported by a specific TOBY-R2 module product version should be not driven by an external device (see the TOBY-R2 series Data Sheet [3] and the TOBY-R2 series System Integration Manual [5] for the features supported by each TOBY-R2 module product version).

1.6.2 EVK-R2 for LARA-R2 series modules

| LARA-R2 series | | DIL B2B | LARA-R2 series | | DIL B2B | LARA-R2 series | | DIL B2B |
|----------------|-------------|--------------------------|----------------|----------|--------------------------|----------------|-----------|----------------|
| Pin N° | Name | Name / Pin N° | Pin N° | Name | Name / Pin N° | Pin N° | Name | Name / Pin N° |
| 1 | GND | J301 Pins 7-10 | 24 | GPIO3 | J301 Pin 32 | 47 | SDIO_D0 | J300 Pin 17 |
| 2 | V_BCKP | J301 Pin 3 | 25 | GPIO4 | J301 Pin 25 | 48 | SDIO_D3 | J301 Pin 39 |
| 3 | GND | J301 Pins 7-10 | 26 | SDA | J300 Pin 21 | 49 | SDIO_D1 | J301 Pin 37 |
| 4 | V_INT | J301 Pin 36 | 27 | SCL | J300 Pin 20 | 50 | GND | J301 Pins 7-10 |
| 5 | GND | J301 Pins 7-10 | 28 | USB_D- | Not present | 51 | VCC | J300 Pins 7-10 |
| 6 | DSR | J301 Pin 18 | 29 | USB_D+ | Not present | 52 | VCC | J300 Pins 7-10 |
| 7 | RI | J301 Pin 17 | 30 | GND | J301 Pins 7-10 | 53 | VCC | J300 Pins 7-10 |
| 8 | DCD | J301 Pin 11 | 31 | RSVD | Not present | 54 | GND | J301 Pins 7-10 |
| 9 | DTR | J301 Pin 12 | 32 | GND | J301 Pins 7-10 | 55 | GND | J301 Pins 7-10 |
| 10 | RTS | J301 Pin 13 | 33 | RSVD | Not present | 56 | ANT1 | Not present |
| 11 | CTS | J301 Pin 14 | 34 | I2S_WA | Not present ⁴ | 57 | GND | J301 Pins 7-10 |
| 12 | TXD | J301 Pin 15 | 35 | I2S_TXD | Not present ⁴ | 58 | GND | J301 Pins 7-10 |
| 13 | RXD | J301 Pin 16 | 36 | I2S_CLK | Not present ⁴ | 59 | ANT_DET | Not present |
| 14 | GND | J301 Pins 7-10 | 37 | I2S_RXD | Not present ⁴ | 60 | GND | J301 Pins 7-10 |
| 15 | PWR_ON | J301 Pin 29 | 38 | SIM_CLK | J300 Pin 15 | 61 | GND | J301 Pins 7-10 |
| 16 | GPIO1 | J301 Pin 33 | 39 | SIM_IO | J300 Pin 14 | 62 | ANT2 | Not present |
| 17 | VUSB_DET | Not present | 40 | SIM_RST | J300 Pin 16 | 63 | GND | J301 Pins 7-10 |
| 18 | RESET_N | J300 Pin 26 | 41 | VSIM | J300 Pin 13 | 64 | GND | J301 Pins 7-10 |
| 19 | GPIO6 | Not present ⁴ | 42 | GPIO5 | J301 Pin 23 | 65-96 | GND | J301 Pins 7-10 |
| 20 | GND | J301 Pins 7-10 | 43 | GND | J301 Pins 7-10 | 97 | RSVD | Not present |
| 21 | HOST_SELECT | J301 Pin 21 | 44 | SDIO_D2 | J301 Pin 30 | 98 | RSVD | Not present |
| 22 | GND | J301 Pins 7-10 | 45 | SDIO_CLK | J300 Pin 19 | 99 | HSIC_DATA | Not present |
| 23 | GPIO2 | J301 Pin 31 | 46 | SDIO_CMD | J300 Pin 18 | 100 | HSIC_STRB | Not present |

Table 6: Interfaces of LARA-R2 series module, as routed on the 42-pin Dual-In-Line Board-to-Board connectors (J300, J301) available on the adapter board ADP-R2 of the EVK-R2 evaluation kit

⁴ OR jumper can be populated in order to route the signal to the 42-pin Dual-In-Line Board-to-Board connectors

| DIL B2B J301 | | | | DIL B2B J300 | | | |
|---------------|--------|--------|---------------|---------------|--------|--------|---------------|
| Signal Name | Pin N° | Pin N° | Signal Name | Signal Name | Pin N° | Pin N° | Signal Name |
| Not connected | 2 | 1 | GND | Not connected | 2 | 1 | GND |
| Not connected | 4 | 3 | V_BCKP | Not connected | 4 | 3 | Not connected |
| Not connected | 6 | 5 | Not connected | Not connected | 6 | 5 | Not connected |
| GND | 8 | 7 | GND | VCC | 8 | 7 | VCC |
| GND | 10 | 9 | GND | VCC | 10 | 9 | VCC |
| DTR | 12 | 11 | DCD | Not connected | 12 | 11 | Not connected |
| CTS | 14 | 13 | RTS | SIM_IO | 14 | 13 | VSIM |
| RXD | 16 | 15 | TXD | SIM_RST | 16 | 15 | SIM_CLK |
| DSR | 18 | 17 | RI | SDIO_CMD | 18 | 17 | SDIO_D0 |
| Not connected | 20 | 19 | Not connected | SCL | 20 | 19 | SDIO_CLK |
| Not connected | 22 | 21 | HOST_SELECT | Not connected | 22 | 21 | SDA |
| Not connected | 24 | 23 | GPIO5 | Not connected | 24 | 23 | Not connected |
| Not connected | 26 | 25 | GPIO4 | RESET_N | 26 | 25 | Not connected |
| Not connected | 28 | 27 | Not connected | MIC_BIAS | 28 | 27 | MIC_GND |
| SDIO_D2 | 30 | 29 | PWR_ON | Not connected | 30 | 29 | Not connected |
| GPIO3 | 32 | 31 | GPIO2 | Not connected | 32 | 31 | Not connected |
| Not connected | 34 | 33 | GPIO1 | SPK_N | 34 | 33 | SPK_P |
| V_INT | 36 | 35 | Not connected | Not connected | 36 | 35 | Not connected |
| Not connected | 38 | 37 | SDIO_D1 | Not connected | 38 | 37 | Not connected |
| Not connected | 40 | 39 | SDIO_D3 | Not connected | 40 | 39 | Not connected |
| GND | 42 | 41 | GND | GND | 42 | 41 | Not connected |

Table 7: Pin-out of the 42-pin Dual-In-Line Board-to-Board connectors (J301, J300) available on the adapter board ADP-R2 of the EVK-R2 evaluation kit for LARA-R2 series modules

 The pins / interfaces that are not supported by a specific LARA-R2 module product version should not be driven by an external device (see the LARA-R2 series Data Sheet [4] and the LARA-R2 series System Integration Manual [6] for the features supported by each LARA-R2 module product version).

1.7 Software installation

The USB drivers are available with the EVK-R2. Executable files can be downloaded from www.u-blox.com/evk-downloads and saved to any location on the computer hard drive. The installation can be started by running the executable file on a computer with the Windows operating system.

1.8 Board setup

1. Insert a SIM card into the **SIM card holder** (J300 on the EVB).
2. Connect a cellular antenna provided with the evaluation kit box to the **Primary cellular antenna** SMA connector on the ADP-R2 (ANT1, RF input/output for transmission and reception of LTE/3G/2G RF signals)
3. Connect a cellular antenna provided with the evaluation kit box to the **Secondary cellular antenna** SMA connector on the ADP-R2 (ANT2, RF input for the reception of the LTE RF signals as per

Down-Link Rx diversity). Place the secondary cellular antenna far enough from the primary cellular antenna (should be more than 20 cm).

4. If the GNSS functionality is required, connect the GNSS antenna provided with the evaluation kit box to the **GNSS antenna** SMA connector on the EVB. Place the GNSS antenna in a location with a good view of the sky.

 Since the interface to the GNSS module is not supported by LARA-R204-02B-00 / LARA-R211-02B-00 / TOBY-R200-02B-00 / TOBY-R202-02B-00 modules, the following changes are needed on the ADP-GNSS to appropriately provide supply to the GNSS:

- R106 = 0R, instead of not installed
 - R107 = Do not install, instead of 0R
5. Connect the AC / DC +12 V power adapter provided with the evaluation kit box to the **9 – 18 V Power Input** connector (J400 on the EVB). LED DL401 lights blue.
 6. Be sure to provide a jumper socket on the **Cellular VCC supply jumper** (J404 on the EVB). This provides the connection from the 3.8 V output of the supply circuit on the EVB to the VCC input of the module.
 7. To enable the board power supply, turn the **Main power switch** (SW400 on the EVB) to the ON position. LED DL400 lights green. The cellular module switches on.

 If the cellular module has been powered off by the AT+CPWROFF command, press the **Cellular Power-On** button (SW302 on EVB) or the **Cellular Reset** button (SW303 on EVB) to switch on the module again.

8. For communication via the cellular module's USB interface, connect a USB cable to the **Cellular native USB** connector (on ADP-R2). LED DS100 on ADP lights blue.

After the end of the module boot, the COM ports listed in [Table 8](#) are enabled by the Windows USB driver (details as the numbering of the ports can be seen via the Windows Device Manager)⁵:

| Parameter | Type | Remarks |
|-------------------------------|-------------------|---|
| u-blox Modem USB1 AT and data | Modems | AT command interface and data communication |
| u-blox Modem USB2 AT and data | Ports (COM & LPT) | AT command interface and data communication |
| u-blox Modem USB3 AT and data | Ports (COM & LPT) | AT command interface and data communication |
| u-blox Modem USB4 GNSS | Ports (COM & LPT) | GNSS tunneling |
| u-blox Modem USB5 SAP | Ports (COM & LPT) | Remote SIM Access profile |
| u-blox Modem USB6 Primary Log | Ports (COM & LPT) | Diagnostic purpose |

Table 8: Cellular USB interface configuration

Run an AT terminal application (e.g. the u-blox m-center tool) selecting an AT port, with these settings:

- Data rate: 115,200 bit/s
- Data bits: 8
- Parity: N
- Stop bits: 1
- Flow control: HW

See [Appendix A](#) for how to configure the u-blox m-center AT terminal for Windows.

⁵ A message of “driver installation fail” may appear on Windows if the USB cable has been connected before the end of the module boot, but this can be ignored as the normal operating functionality of the module will be available anyway after the end of the module boot.

9. For communication via the cellular module's UART interface, the following connections are allowed and can be alternatively enabled in a mutually exclusive way (see [Table 9](#) for the switch position and LED status):
 - a. Connect a USB cable to the mini USB connector (**Cellular USB**, J501 on EVB), LED DL501 lights blue
 - b. Connect an RS232 cable to the DB9 connector (**Cellular RS232**, J500 on EVB)

When a USB cable is connected to the mini USB connector, two COM ports are enabled in Windows (the numbering of the COM ports can be seen via the Windows Device Manager). The serial port for AT commands is available over the first numbered COM port opened by the driver.

| Type of connections | SW401 | SW403 | LED |
|--|----------|-------------|-------|
| Access to cellular UART over the Cellular USB (UART) mini USB connector (J501) | ON BOARD | MINIUSB | DL403 |
| Access to cellular UART over the Cellular RS232 (UART) DB9 connector (J500) | ON BOARD | DB9 | DL405 |
| Access to cellular UART on the DIL Board-to-Board connector on the adapter board: cellular UART detached from USB (UART) J501 and RS232 (UART) J500 connectors | B2B | Do not care | DL404 |

Table 9: Serial interface configuration

Run an AT terminal application (e.g. the u-blox m-center tool) selecting an AT port, with these settings:

- Data rate: 115,200 bit/s
- Data bits: 8
- Parity: N
- Stop bits: 1
- Flow control: HW

See [Appendix A](#) for how to configure the u-blox m-center AT terminal for Windows.

10. If the audio functionality is required, connect the headset provided with the evaluation kit box to the **Headset jack** connector (J303 on EVB).



Audio is not supported by LARA-R204-02B and LARA-R220-62B product versions.

1.9 Enabling error result codes

| Command sent by DTE (user) | DCE response (module) | Description |
|----------------------------|-----------------------|---|
| AT+CMEE=2 | OK | Enables the cellular module to report verbose error result codes. |

1.10 PIN code insertion (when required)

| Command sent by DTE (user) | DCE response (module) | Description |
|----------------------------|-----------------------|--|
| AT+CPIN="8180" | OK | Enter the PIN code, if needed (enter the PIN of the SIM card – 8180 is written here as an example). |
| AT+CLCK="SC", 0, "8180" | OK | Unlock the PIN at power-on (the last parameter is the PIN of the SIM card – 8180 is written here as an example). |
| AT+CLCK="SC", 1, "8180" | OK | Lock the PIN at power-on (the last parameter is the PIN of the SIM card – 8180 is written here as an example). |

1.11 Registration on a cellular network

| Command sent by DTE (user) | DCE response (module) | Description |
|----------------------------|----------------------------|--|
| AT+CREG? | +CREG: 0,1 OK | Verify the network registration. |
| AT+COPS=0 | OK | Register the module on the network. The cellular module automatically registers itself on the cellular network. This command is necessary only if the automatic registration failed (AT+CREG? returns 0,0). |
| AT+COPS? | +COPS: 0,0,"I TIM",7 OK | Read the operator name and radio access technology (RAT). |

For further AT command examples regarding Mobile Network Operator, Radio Access Technology, and band selection and configuration, see the u-blox AT Commands Examples Application Note [\[2\]](#).

1.12 Enable audio codec configuration to provide voice capability

| Command sent by DTE (user) | DCE response (module) | Description |
|----------------------------|---|---|
| AT+UGPIOC? | TOBY-R2 case: LARA-R2 case: +UGPIOC: +UGPIOC: 21,255 16,255 22,255 23,255 24,255 24,255 25,0 25,0 50,12 34,12 51,12 35,12 52,12 36,12 53,12 37,12 60,7 42,7 OK OK | Check the configuration of I2S pins (<gpio_id> = 50, 51, 52, 53 for TOBY-R2, <gpio_id> = 34, 35, 36, 37 for LARA-R2): they must be configured as I2S digital audio interface (<gpio_mode> = 12, as the factory-programmed value) to provide voice capability at the headset jack connector using the external audio codec mounted on the EVK-R2. |
| AT+USPM? | +USPM: 1,1,0,0,2 OK | Check the audio path mode setting: both the up-link and the down-link paths need to be configured as I2S digital audio interfaces (e.g. <main_uplink> = 1, <main_downlink> = 1, as the factory-programmed value) to provide voice capability at the headset jack connector using the external audio codec mounted on the EVK-R2. |
| AT+UEXTDCONF=0,1 | OK | Enable the automatic configuration of the external Maxim MAX9860 audio codec mounted on the EVK-R2. The setting is saved in the non-volatile memory (NVM) and it is applied at each subsequent module power-on. |
| AT+CPWROFF | OK | Switch off the EVK-R2. The external Maxim MAX9860 audio codec mounted on the EVK-R2 will be fed by the 13 MHz master clock provided by the GPIO6 and it will be dynamically programmed over the I ² C interface at any subsequent re-boot of the module and every time the audio path is enabled, providing voice capability at the headset jack connector of the EVK-R2. |

1.13 Switching off the EVK-R2

To switch off the EVK-R2, send the +CPWROFF AT command. Make sure to use this command before switching off the main power, otherwise settings and configuration parameters may not be saved in the internal non-volatile memory of the cellular module.

B Setting up cellular packet data connection on PC

This section describes how to set up a packet data connection with the Windows 7 operating systems (for PC) and EVK-R2, using the TCP/IP stack of the PC (external TCP/IP stack).

The following examples describe how to install and configure two different kinds of modem on Windows:

1. Low data rate modem, over the UART interface of the cellular module connected to the Windows PC by the **Cellular USB** connector (J501 on EVB) or the **Cellular RS232** connector (J500 on EVB)
2. High data rate modem, over the native USB interface of the cellular module connected to the Windows PC by the **Cellular Native USB** connector on the ADP

B.1 How to install and configure a low data rate modem connection

This example describes how to install and configure a low data rate packet data connection on a PC with the Windows 7 operating system. This uses the TCP/IP stack of the PC over the UART interface of the cellular module connected to the Windows PC by the **Cellular USB** connector (J501 on EVB) or the **Cellular RS232** connector (J500 on EVB).

1. Follow the board setup instructions in section 1.8 to provide the required connections with EVK-R2.

2. Select “Control panel > Phones and Modem > Modems > Add”. This opens the Install New Modem Wizard.
3. Select the **Don't detect my modem** checkbox.

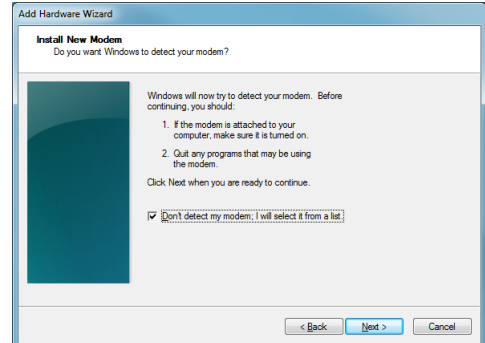

4. Select the Standard Modem (33,600 bit/s).

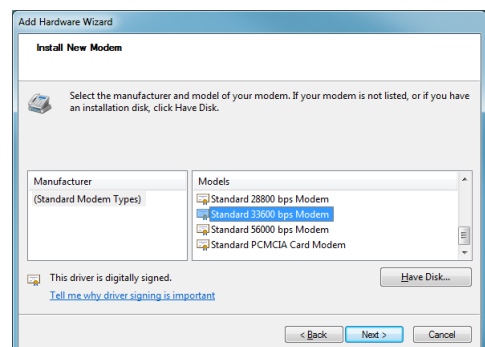

5. Set the COM port on which the modem will be installed.

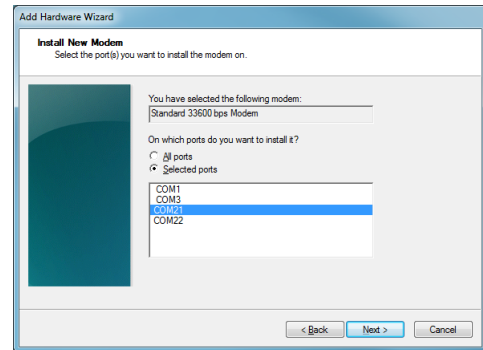

6. Select “Control panel > Phones and Modem > Modems > Standard Modem 33,600 bps Modem > Properties”.
7. Select “Change Settings > Advanced”.
8. Add APN settings command (APN shown is just an example. Make sure to have the correct APN defined by the network operator).
9. Click on **Change Default Preferences**.

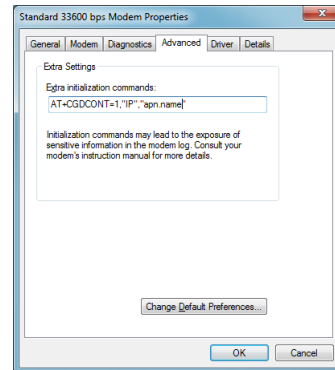

10. Click on **OK** twice and the new connection is now ready to be configured.

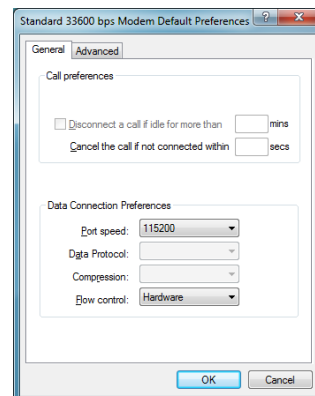

11. To configure a new connection, select “Control Panel > Network and Sharing Center > Set up a new connection or network”.

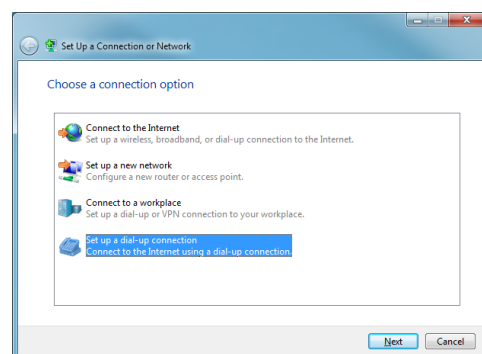

12. Select the modem, if requested (the question appears only if more than one modem is available).

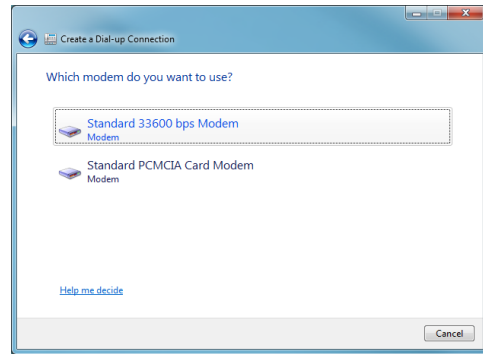

13. Enter parameters for dial-up connection:
 - The module telephone number (*99***1#)
 - The specific GPRS account information for the network operator
 - A name for the new connection (e.g. “u-blox GPRS Connection”)

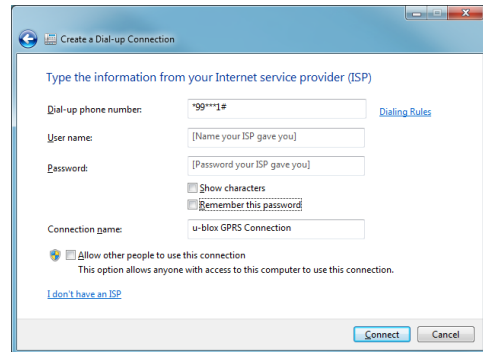

14. The packet data connection is now ready to be used with the EVK-R2. To check the connection, start a browser.



Consult the cellular network operator for the username and password. In most cases, these can be left empty.

B.2 How to install and configure a high data rate modem connection

This example describes how to install and configure a high data rate packet data connection on a PC with the Windows 7 operating system, using the TCP/IP stack of the PC, over the native USB interface of the cellular module connected to the Windows PC by the **Cellular Native USB** connector on the ADP.

1. Follow the board setup instructions in section 1.8 to provide the required connections with EVK-R2.

2. Select: "Control Panel > Network and Internet > Network and Sharing Center > Setup a new connection or network"
This opens the "Choose a connection option" Wizard.

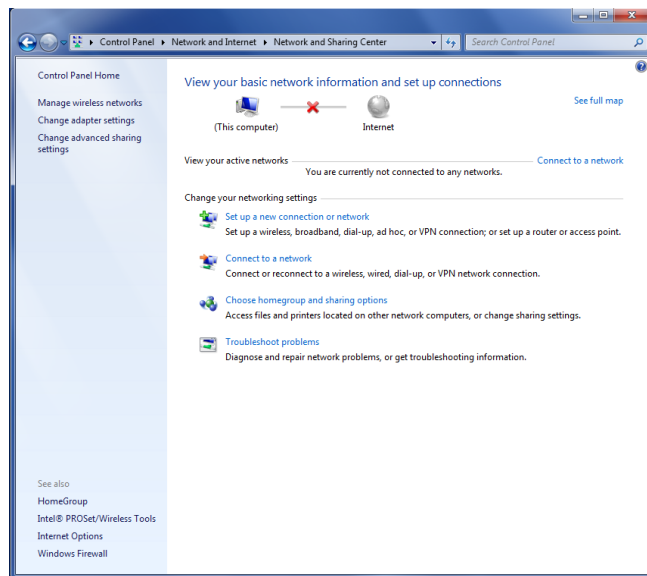

3. Select **Set up a dial-up connection**. Click on **Next**.

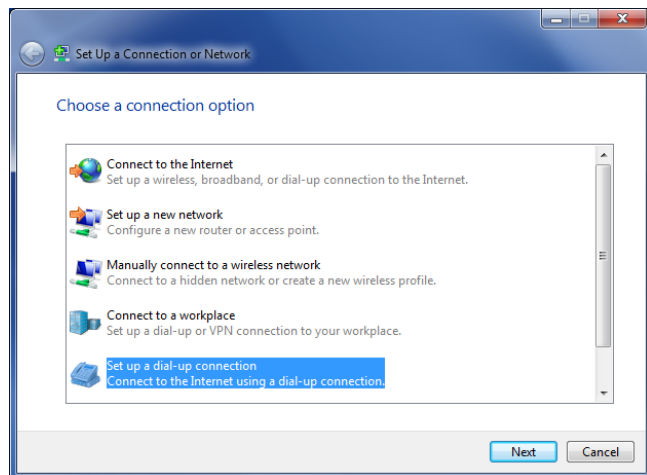

4. Select **u-blox Modem USB1 AT and Data #X** (X=7 in the picture).

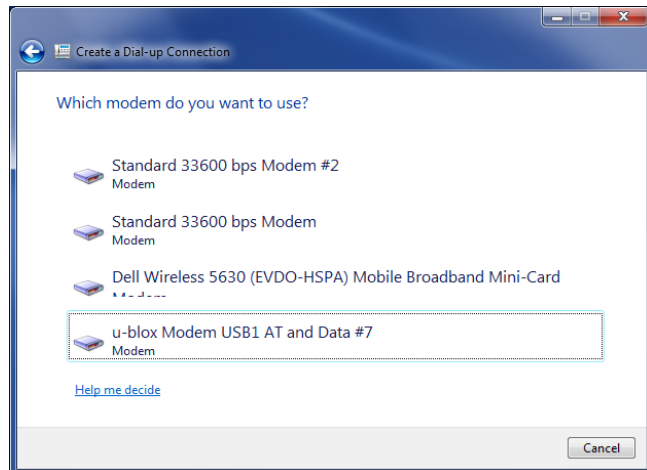

5. Enter the modem telephone number (*99***1#), select **Allow other people to use this connection** and click **Connect** to finalize the procedure.

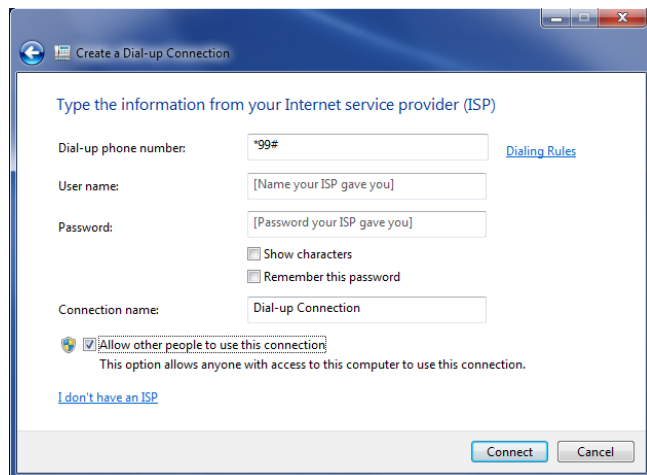

-  Consult the cellular network operator for the username and password. In most cases, these can be left empty.

C Examples of AT commands

For the complete description and syntax of the AT commands supported by each TOBY-R2 and LARA-R2 series cellular module product version, see the u-blox AT commands Manual [1].

For detailed examples of AT commands for network registration and configuration, context activation, data connection management, SIM management, module interfaces configurations and other settings, see the u-blox AT Commands Examples Application Note [2].

C.1 Define the initial default bearer for connectivity

To change the PDN settings for the initial default EPS bearer established during LTE attach, edit the <cid>=1 PDN by means of the AT+CGDCONT AT command.

| Command sent by DTE (user) | DCE response (module) | Description |
|--|--|---|
| AT+COPS? | +COPS: 2 OK | Module is not registered. |
| AT+CREG=2;+CGREG=2;+CEREG=2;+CGERE P=1,1;+CIREG=1 | OK | Enable a set of registration URC, including PS, CS, EPS and IMS registration events. |
| AT+CGDCONT? | +CGDCONT: 1,"IPV4V6","", "",0,0 OK | Read IP type and APN for EPS attach bearer. |
| AT+CGDCONT=1,"IPV4V6","broadband" | OK | Set APN name (i.e. "broadband") and the PDP type (i.e. "IPV4V6") for EPS attach bearer. |
| AT+COPS=0 | OK +CGEV: NW CLASS A +CREG: 1,"7CFF","00051235",6 +CGREG: 1,"7CFF","00051235",6,"F" F" +CEREG: 1,"8305","04C87A0F",7 +CGEV: ME PDN ACT 1 | Trigger registration and wait for LTE attach complete. |
| ATD*99***1# | CONNECT | Establish a PPP/dialup data session. |

D Current consumption measurement

The current consumption of TOBY-R2 or LARA-R2 series modules can be measured on the EVK-R2 by removing the jumper socket from the **Cellular VCC supply jumper** (J404 on the EVB), described in [Figure 6](#).

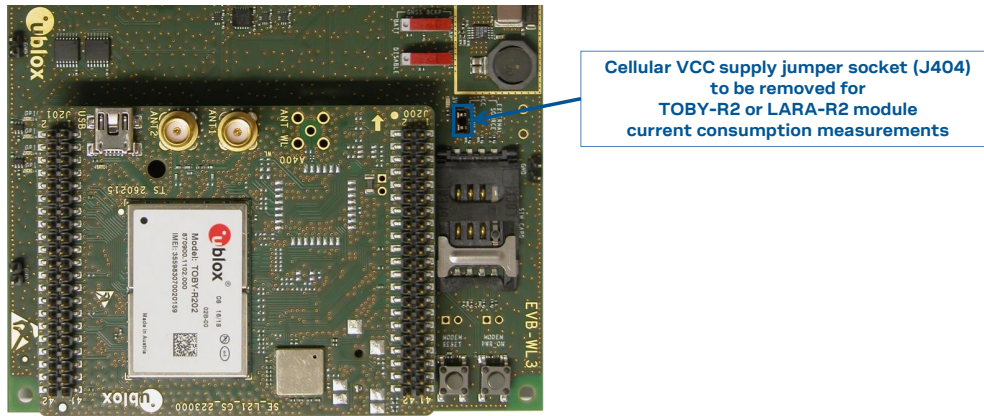

Figure 6: Jumper socket to be removed for TOBY-R2 or LARA-R2 series modules current consumption measurement

A suitable external digital multi-meter (as for example the Agilent 34410A or 34411A) can be used for current consumption measurements: in this case, the 3.8 V supply circuit on the EVB will supply the TOBY-R2 or LARA-R2 module mounted on the adapter board, with the digital multi-meter placed in series as illustrated in [Figure 7](#).

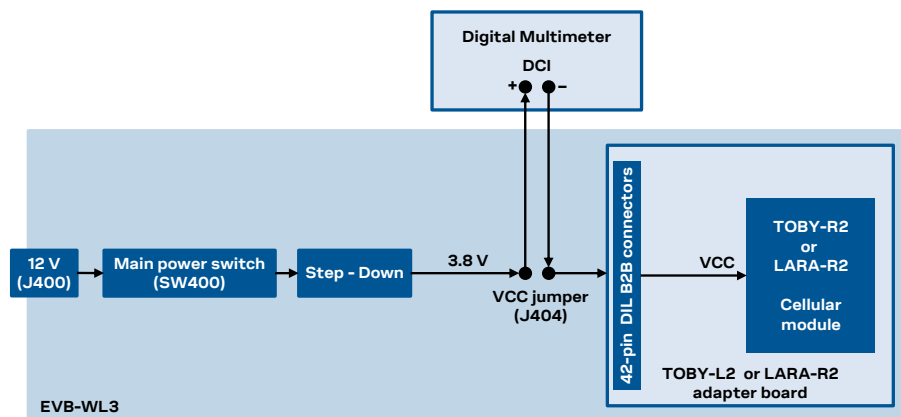

Figure 7: Block diagram of current consumption setup for TOBY-R2 or LARA-R2 series modules

Alternatively, a suitable external DC power supply with the dynamic current measurement capabilities (as for example, the Agilent 66319B/D) can be used for current consumption measurements, acting also as the 3.8 V supply source for the TOBY-R2 or LARA-R2 module mounted on the adapter board.

E Glossary

| Abbreviation | Definition |
|--------------|---|
| ADP | Adapter Board |
| APN | Access Point Name |
| AT | AT Command Interpreter Software Subsystem, or attention |
| B2B | Board-To-Board |
| CS | Circuit Switched |
| CTS | Clear To Send |
| DDC | Display Data Channel |
| DIL | Dual In Line |
| EPS | Evolved Packet System |
| EVB | Evaluation Board |
| EVK | Evaluation Kit |
| GND | Ground |
| GNSS | Global Navigation Satellite System |
| GPIO | General Purpose Input Output |
| GPRS | General Packet Radio Service |
| IMS | IP Multimedia Subsystem |
| IP | Internet Protocol |
| LDO | Low Drop-Out |
| LED | Light Emitting Diode |
| LTE | Long Term Evolution |
| NVM | Non-Volatile Memory |
| PIN | Personal Identification Number |
| PS | Packet Switch |
| RAT | Radio Access Technology |
| RF | Radio Frequency |
| RI | Ring Indicator |
| SIM | Subscriber Identity Module |
| TCP | Transfer Control Protocol |
| UART | Universal Asynchronous Receiver-Transmitter |
| URC | Unsolicited Result Code |
| USB | Universal Serial Bus |
| VCC | Voltage Common Collector |

Table 10: Explanation of the abbreviations and terms used

F Declaration of conformities

The equipment is intended for indoor usage. It is the user's duty to verify if further restrictions apply, such as in airplanes, hospitals or hazardous locations (petrol stations, refineries...).

Any changes or modification made to this equipment will void its compliance to the safety requirements.

Maintenance, inspections and/or repairs of the EVK-R2 shall be performed by u-blox AG.

Related documents

- [1] u-blox AT commands manual, Doc. No. [UBX-13002752](#)
- [2] u-blox AT Commands Examples Application Note, Doc. No. [UBX-13001820](#)
- [3] u-blox TOBY-R2 series Data Sheet, Doc. No. [UBX-16005785](#)
- [4] u-blox LARA-R2 series Data Sheet, Doc. No. [UBX-16005783](#)
- [5] u-blox TOBY-R2 series System Integration Manual, Doc. No. [UBX-16010572](#)
- [6] u-blox LARA-R2 series System Integration Manual, Doc. No. [UBX-16010573](#)

 For regular updates to u-blox documentation and to receive product change notifications, register on our homepage (www.u-blox.com).

Revision history

| Revision | Date | Name | Comments |
|----------|-------------|------|---|
| R01 | 15-Jul-2016 | sses | Initial release |
| R02 | 23-Sep-2016 | sses | Updated status to Advance Information Corrected external audio codec configuration example |
| R03 | 23-Dec-2016 | sses | "Disclosure restriction" replaces "Document status" on page 2 and document footer Updated document applicability to EVK-R200, EVK-R202, EVK-R204 and EVK-R211 evaluation kits with Engineering Sample product status |
| R04 | 02-Mar-2017 | lpah | Updated IP FW version of EVK-R200-00B-00 / EVK-R202-00B-00 |
| R05 | 17-Mar-2017 | sses | Extended document applicability to EVK-R203 |
| R06 | 19-Apr-2017 | lpah | Updated IP FW version of EVK-R204-00B-00 / EVK-R211-00B-00 |
| R07 | 30-Jun-2017 | lpah | Added EVK-R220 and EVK-R280; Updated status of EVK-R203; Added note about GNSS interface not available |
| R08 | 20-Oct-2017 | lpah | Updated FW version of EVK-R203, EVK-R220, EVK-R280 |
| R09 | 18-Dec-2017 | lpah | Updated EVK-R280 product status |
| R10 | 01-Jul-2019 | lpah | Updated EVK-R2 product status |