

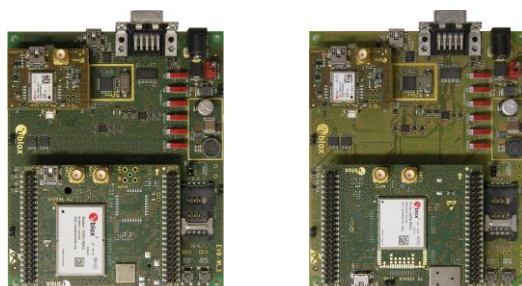

EVK-R2

TOBY-R2 and LARA-R2 series Cellular Evaluation Kits

User Guide



Abstract

This guide explains how to set up the EVK-R2 Evaluation Kits to begin evaluating the u-blox TOBY-R2 and/or LARA-R2 series cellular modules supporting LTE Cat 1 / 3G / 2G radio access technologies.

Document Information

Title	EVK-R2	
Subtitle	TOBY-R2 and LARA-R2 series Cellular Evaluation Kits	
Document type	User Guide	
Document number	UBX-16016088	
Revision and date	R10	01-Jul-2019

Disclosure Restriction

Product status	Corresponding content status	
Functional Sample	Draft	For functional testing. Revised and supplementary data will be published later.
In Development / Prototype	Objective Specification	Target values. Revised and supplementary data will be published later.
Engineering Sample	Advance Information	Data based on early testing. Revised and supplementary data will be published later.
Initial Production	Early Production Information	Data from product verification. Revised and supplementary data may be published later.
Mass Production / End of Life	Production Information	Document contains the final product specification.

This document applies to the following products:

Product name	Type number	Modem version	Application version	PCN reference	Product status
EVK-R200	EVK-R200-00B-00	30.31	A01.01	UBX-17006265	Mass Production
EVK-R202	EVK-R202-00B-00	30.31	A01.01	UBX-17006265	Mass Production
EVK-R203	EVK-R203-00B-00	30.39	A01.00	UBX-17048311	Mass Production
EVK-R204	EVK-R204-00B-00	31.34	A01.00	UBX-17012269	Mass Production
EVK-R211	EVK-R211-00B-00	30.31	A01.00	UBX-17012270	Mass Production
EVK-R220	EVK-R220-00B-00	30.43	A01.01	UBX-17061668	Mass Production
EVK-R280	EVK-R280-00B-00	30.43	A01.01	UBX-17063950	Mass Production

u-blox or third parties may hold intellectual property rights in the products, names, logos and designs included in this document. Copying, reproduction, modification or disclosure to third parties of this document or any part thereof is only permitted with the express written permission of u-blox.

The information contained herein is provided "as is" and u-blox assumes no liability for its use. No warranty, either express or implied, is given, including but not limited to, with respect to the accuracy, correctness, reliability and fitness for a particular purpose of the information. This document may be revised by u-blox at any time without notice. For the most recent documents, visit www.u-blox.com.

Copyright © u-blox AG.

Contents

Document Information	2
Contents	3
1 Starting up	4
1.1 EVK-R2 overview	4
1.2 EVK-R2 block diagram	7
1.3 Switches, jumpers and buttons	8
1.4 LEDs.....	8
1.5 Connectors	9
1.6 EVK-R2 pin out.....	10
1.6.1 EVK-R2 for TOBY-R2 series modules	10
1.6.2 EVK-R2 for LARA-R2 series modules	12
1.7 Software installation	13
1.8 Board setup	13
1.9 Enabling error result codes	15
1.10 PIN code insertion (when required).....	15
1.11 Registration on a cellular network.....	16
1.12 Enable audio codec configuration to provide voice capability	16
1.13 Switching off the EVK-R2.....	16
Appendix	17
A Setting up AT terminal applications for communication with EVK-R2	17
B Setting up cellular packet data connection on PC	18
B.1 How to install and configure a low data rate modem connection	18
B.2 How to install and configure a high data rate modem connection	21
C Examples of AT commands	23
C.1 Define the initial default bearer for connectivity	23
D Current consumption measurement	24
E Glossary	25
F Declaration of conformities	25
Related documents	26
Revision history	26
Contact	27

1 Starting up

1.1 EVK-R2 overview

The EVK-R2 kits are powerful and easy-to-use tools that simplify the evaluation of u-blox TOBY-R2 and LARA-R2 series multimode LTE Cat 1/3G/2G cellular modules.

The following evaluation kits are available with u-blox TOBY-R2 cellular modules (see [Figure 1](#)):

- EVK-R200 evaluation kit is for evaluation of TOBY-R200
- EVK-R202 evaluation kit is for evaluation of TOBY-R202

The following evaluation kits are available with u-blox LARA-R2 cellular modules (see [Figure 2](#)):

- EVK-R203 evaluation kit is for evaluation of LARA-R203
- EVK-R204 evaluation kit is for evaluation of LARA-R204
- EVK-R211 evaluation kit is for evaluation of LARA-R211
- EVK-R220 evaluation kit is for evaluation of LARA-R220
- EVK-R280 evaluation kit is for evaluation of LARA-R280

All the EVK-R200, EVK-R202, EVK-R203, EVK-R204, EVK-R211, EVK-R220, EVK-R280 evaluation kits are herein identified as EVK-R2.

 See the TOBY-R2 series Data Sheet [\[3\]](#), LARA-R2 series Data Sheet [\[4\]](#), TOBY-R2 series System Integration Manual [\[5\]](#) and LARA-R2 series System Integration Manual [\[6\]](#) for the features supported by the u-blox TOBY-R2 and LARA-R2 series cellular modules.

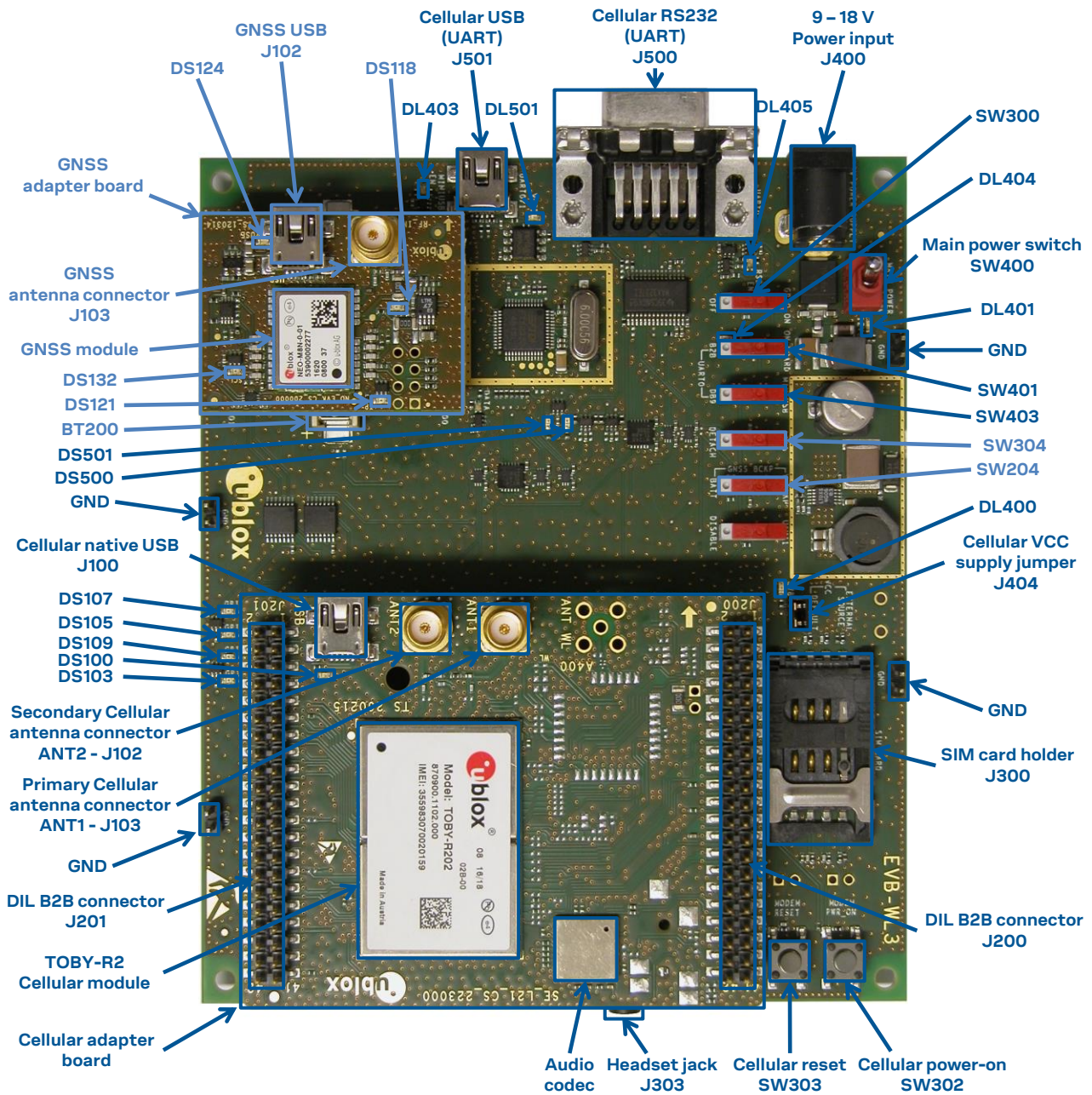

Figure 1: Overview of EVK-R2 evaluation kit for TOBY-R2 modules

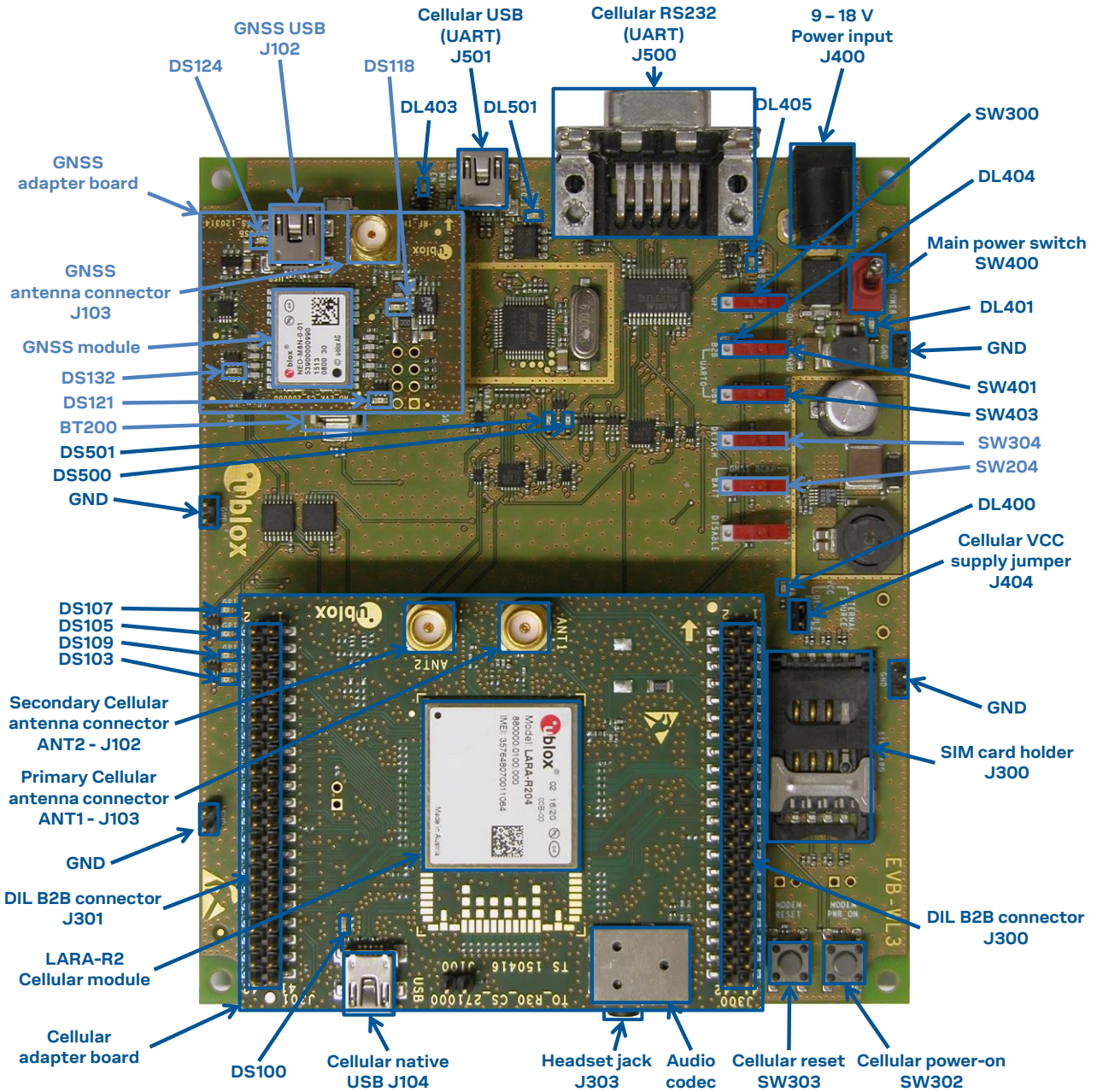

Figure 2: Overview of EVK-R2 evaluation kit for LARA-R2 modules

1.2 EVK-R2 block diagram

Figure 3 shows the main interfaces and internal connections of the EVK-R2 evaluation kit:

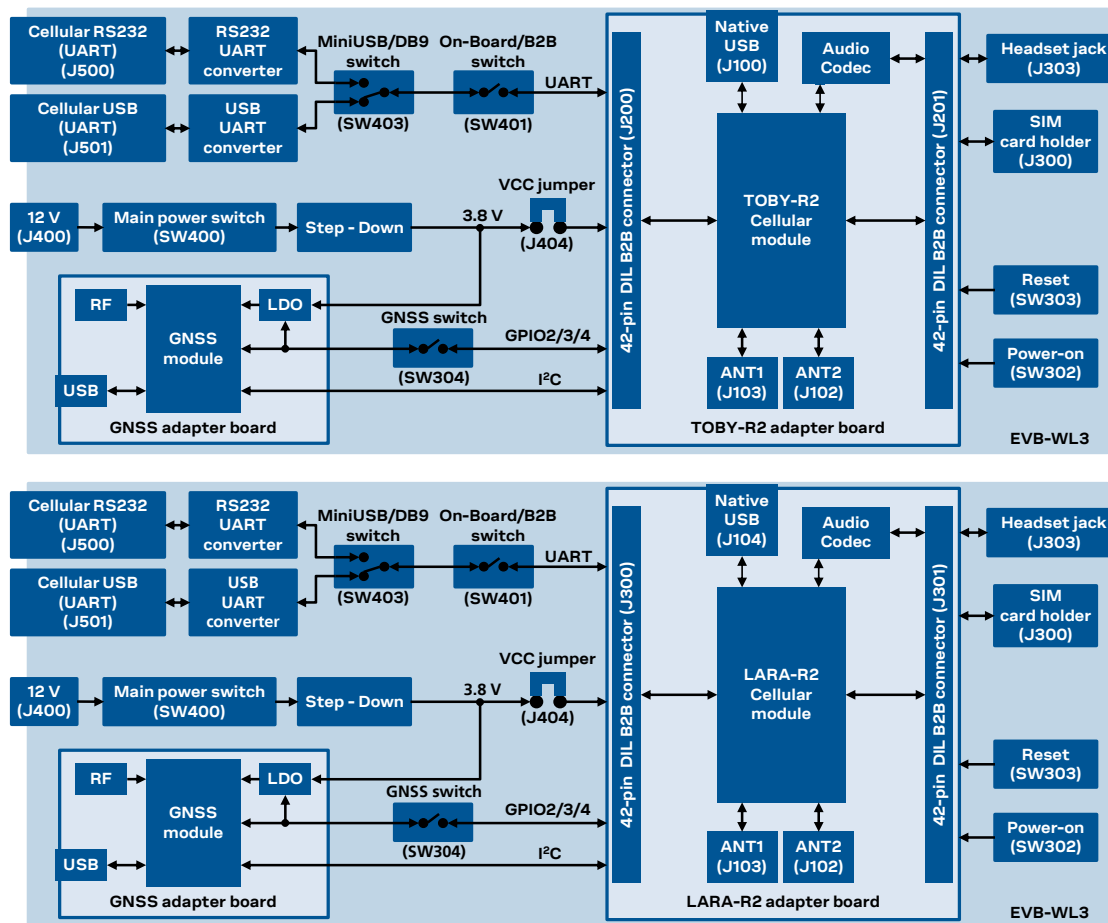

Figure 3: Block diagram of EVK-R2 for TOBY-R2 modules (shown on top) and LARA-R2 modules (shown on bottom)

The EVK-R2 is formed by three boards:

- The lower one, called EVB-WL3, contains the power supply and other peripherals for the TOBY-R2 series or the LARA-R2 series cellular module (SIM card holder, Reset button and Power-on button).
- The cellular adapter board, called ADP-R2, contains the TOBY-R2 or LARA-R2 cellular module, the cellular antenna connectors, the USB connector for the cellular module, and an audio codec.
- The GNSS adapter board, called ADP-GNSS, contains the u-blox GNSS module, the GNSS antenna connector and the USB connector for the GNSS module.

The boards are connected by means of male header board-to-board connectors provided on the bottom of the adapter boards and their corresponding female connectors provided on the top of the lower board.

The USB interface of the cellular module is available on the native USB connector on the cellular adapter board, while the other peripherals are available on the Dual-In-Line male Board-to-Board connectors provided on the top layer of the cellular Adapter Board (J200 / J201 or J300 / J301), which are pin-to-pin compatible to the connectors on the bottom layer of the adapter board.

The lower board (EVB-WL3) is designed to also be used with other u-blox cellular adapter boards. It contains additional switches, jumpers, connectors, LEDs and parts that are partially described in Figure 1/ Figure 2 or in this document, because they are intended for use only with other u-blox cellular modules. It is recommended to leave any additional connector unconnected, and to leave any additional switch in its default configuration.

1.3 Switches, jumpers and buttons

Function	Description	Name	Board
Main Power Switch	Power on / off of the whole evaluation kit	SW400	EVB
Cellular VCC	Jumper socket to provide the 3.8 V supply to the cellular module VCC input	J404	EVB
Cellular Power-on	Push button to switch-on the cellular module	SW302	EVB
Cellular Reset	Push button to reset the cellular module	SW303	EVB
Cellular UART detach	Slide switch to attach / detach cellular module UART from USB / RS232 connectors: when detached, UART signals available only on DIL B2B connector on ADP board	SW401	EVB
Cellular UART routing	Slide switch to select cellular module UART routing on USB or on RS232 connector	SW403	EVB
Cellular GPIO detach	Slide switch to attach / detach the cellular module GPIOs, SIM_DET from peripherals: when detached, the signals are available only on the DIL B2B connector on ADP board	SW300	EVB
Cellular GNSS detach	Slide switch to attach / detach the cellular module to the GNSS module (GPIO2-3-4): when detached, the signals are available only on DIL B2B connector on ADP board	SW304	EVB
GNSS V_BCKP	Slide switch to connect / disconnect backup battery to V_BCKP pin of the GNSS module	SW204	EVB

Table 1: EVK-R2 switch and button descriptions

1.4 LEDs

















Function	Description	LED #	Board	Color
Main Power	Power supply plugged in the 9 - 18 V Power Input	DL401	EVB	
Cellular VCC	Cellular module supplied. Main Power Switch must be switched on	DL400	EVB	
Cellular native USB	USB cable plugged in the Cellular native USB connector	DS100	ADP-R2	
Cellular USB	USB cable plugged in the Cellular USB connector for UART access	DL501	EVB	
Cellular USB / UART	Green light is activated when UART is routed to the Cellular USB connector Red light blinks at UART TX or RX data on the Cellular USB connector	DL403	EVB	
Cellular UART detach	UART signals are available only on the DIL B2B connector on ADP board	DL404	EVB	
Cellular RS232 / UART	Green light is activated when UART is routed to Cellular RS232 connector Red light blinks at UART TX or RX data on the Cellular RS232 connector	DL405	EVB	
Cellular RI indicator	RI line turns ON (active low)	DS501	EVB	
Cellular CTS indicator	CTS line turns ON (active low)	DS500	EVB	
Cellular GPIO1 indicator	Green light is activated when cellular GPIO1 is high	DS107	EVB	
Cellular GPIO2 indicator	Green light is activated when cellular GPIO2 is high	DS105	EVB	
Cellular GPIO3 indicator	Green light is activated when cellular GPIO3 is high	DS109	EVB	
Cellular GPIO4 indicator	Green light is activated when cellular GPIO4 is high	DS103	EVB	
GNSS VCC supply	GNSS module supply is turned ON	DS118	ADP-GNSS	
GNSS USB	USB cable plugged in GNSS USB connector	DS124	ADP-GNSS	
GNSS Timepulse	Pulses at 1 Hz when valid GNSS fix	DS121	ADP-GNSS	
Cellular / GNSS DDC	Cellular / GNSS module communication over the DDC (I ² C) interface	DS132	ADP-GNSS	

Table 2: EVK-R2 LED descriptions

1.5 Connectors



Function	Description	Name	Board
9 - 18 V Power Input	Connector for the AC / DC power adapter of the EVK  IEC 60417-5172 Class II equipment AC: 100-240 V, 0.8 A, 50-60 Hz / DC: +12 V, 2.5 A	J400	EVB
SIM card holder	SIM card holder	J300	EVB
Primary cellular antenna	SMA connector for the cellular module primary antenna (ANT1, Tx/Rx)	J103	ADP-R2
Secondary cellular antenna	SMA connector for the cellular module secondary antenna (ANT2, Rx)	J102	ADP-R2
Cellular native USB	Mini USB connector for the cellular module native USB interface	J100 ¹ J104 ²	ADP-R2
Cellular USB (UART)	Mini USB connector for the cellular module UART interface converted as USB interface	J501	EVB
Cellular RS232 (UART)	DB9 connector for the cellular module UART interface converted as RS232 interface	J500	EVB
DIL B2B headers	Dual-In-Line Board-to-Board connectors for cellular module interfaces	J200-J201 ¹ J300-J301 ²	ADP-R2
Cellular headset	Audio headset jack connector for the cellular module audio interface	J303	EVB
GNSS antenna	SMA connector for the GNSS module antenna (GNSS antenna)	J208	ADP-GNSS
GNSS USB	Mini USB connector for the GNSS module USB interface	J102	ADP-GNSS
GNSS backup battery	Backup battery socket for the GNSS module (under GNSS adapter board)	BT200	EVB
GND	Ground terminals for the probe reference	J402, J403 J405, J406	EVB

Table 3: EVK-R2 connector descriptions

-  CAUTION! IN THE UNLIKELY EVENT OF A FAILURE IN THE INTERNAL PROTECTION CIRCUITRY, THERE IS A RISK OF AN EXPLOSION WHEN CHARGING A FULLY OR PARTIALLY DISCHARGED BATTERY. REPLACE THE BATTERY WHEN IT NO LONGER HAS A SUFFICIENT CHARGE FOR UNIT OPERATION. CONTROL THE BATTERY BEFORE USE IF THE DEVICE HAS NOT BEEN USED FOR AN EXTENDED PERIOD OF TIME.
-  CAUTION! RISK OF EXPLOSION IF BATTERY IS REPLACED WITH AN INCORRECT TYPE. DISPOSE OF USED BATTERIES ACCORDING TO THE INSTRUCTIONS!

¹ EVK-R2xx evaluation kit for TOBY-R2 series modules

² EVK-R2xx evaluation kit for LARA-R2 series modules

1.6 EVK-R2 pin out

1.6.1 EVK-R2 for TOBY-R2 series modules

TOBY-R2 series		DIL B2B	TOBY-R2 series		DIL B2B	TOBY-R2 series		DIL B2B
Pin N°	Name	Name / Pin N°	Pin N°	Name	Name / Pin N°	Pin N°	Name	Name / Pin N°
1	RSVD	Not present	32	GND	J201 Pins 7-10	63	SDIO_D2	Not present ³
2	GND	J201 Pins 7-10	33	RSVD	Not present	64	SDIO_CLK	Not present ³
3	V_BCKP	J201 Pin 3	34	RSVD	Not present	65	SDIO_CMD	Not present ³
4	VUSB_DET	Not present	35	RSVD	Not present	66	SDIO_D0	Not present ³
5	V_INT	J201 Pin 36	36	RSVD	Not present	67	SDIO_D3	Not present ³
6	RSVD	Not present	37	RSVD	Not present	68	SDIO_D1	Not present ³
7	RSVD	Not present	38	RSVD	Not present	69	GND	J201 Pins 7-10
8	RSVD	Not present	39	RSVD	Not present	70	VCC	J200 Pins 7-10
9	RSVD	Not present	40	RSVD	Not present	71	VCC	J200 Pins 7-10
10	DSR	J201 Pin 18	41	RSVD	Not present	72	VCC	J200 Pins 7-10
11	RI	J201 Pin 17	42	RSVD	Not present	73	GND	J201 Pins 7-10
12	DCD	J201 Pin 11	43	RSVD	Not present	74	GND	J201 Pins 7-10
13	DTR	J201 Pin 12	44	GND	J201 Pins 7-10	75	ANT_DET	Not present
14	RTS	J201 Pin 13	45	RSVD	Not present	76	GND	J201 Pins 7-10
15	CTS	J201 Pin 14	46	GND	J201 Pins 7-10	77	RSVD	Not present
16	TXD	J201 Pin 15	47	RSVD	Not present	78	GND	J201 Pins 7-10
17	RXD	J201 Pin 16	48	RSVD	Not present	79	GND	J201 Pins 7-10
18	RSVD	Not present	49	RSVD	Not present	80	GND	J201 Pins 7-10
19	RSVD	Not present	50	I2S_WA	Not present ³	81	ANT1	Not present
20	PWR_ON	J201 Pin 29	51	I2S_TXD	Not present ³	82	GND	J201 Pins 7-10
21	GPIO1	J201 Pin 33	52	I2S_CLK	Not present ³	83	GND	J201 Pins 7-10
22	GPIO2	J201 Pin 31	53	I2S_RXD	Not present ³	84	RSVD	Not present
23	RESET_N	J200 Pin 26	54	SCL	J200 Pin 20	85	GND	J201 Pins 7-10
24	GPIO3	J201 Pin 32	55	SDA	J200 Pin 21	86	GND	J201 Pins 7-10
25	GPIO4	J201 Pin 25	56	SIM_CLK	J200 Pin 15	87	ANT2	Not present
26	HOST_SELECT 0	J201 Pin 2	57	SIM_IO	J200 Pin 14	88	GND	J201 Pins 7-10
27	USB_D-	Not present	58	SIM_RST	J200 Pin 16	89	GND	J201 Pins 7-10
28	USB_D+	Not present	59	VSIM	J200 Pin 13	90	GND	J201 Pins 7-10
29	RSVD	Not present	60	GPIO5	J201 Pin 23	91	RSVD	Not present
30	GND	J201 Pins 7-10	61	GPIO6	Not present ³	92	GND	J201 Pins 7-10
31	RSVD	Not present	62	HOST_SELEC T1	J201 Pin 4	93-152	GND	J201 Pins 7-10

Table 4: Interfaces of TOBY-R2 series modules, as routed on the 42-pin Dual-In-Line Board-to-Board connectors (J200, J201) available on the adapter board ADP-R2 of the EVK-R2 evaluation kit

³ OR jumper can be populated in order to route the signal to the 42-pin Dual-In-Line Board-to-Board connectors

DIL B2B J201			DIL B2B J200				
Signal Name	Pin N°	Pin N°	Signal Name	Signal Name	Pin N°	Pin N°	Signal Name
HOST_SELECT0	2	1	GND	Not connected	2	1	GND
Not connected	4	3	V_BCKP	Not connected	4	3	Not connected
Not connected	6	5	Not connected	Not connected	6	5	Not connected
GND	8	7	GND	VCC	8	7	VCC
GND	10	9	GND	VCC	10	9	VCC
DTR	12	11	DCD	Not connected	12	11	Not connected
CTS	14	13	RTS	SIM_IO	14	13	VSIM
RXD	16	15	TXD	SIM_RST	16	15	SIM_CLK
DSR	18	17	RI	Not connected	18	17	Not connected
Not connected	20	19	Not connected	SCL	20	19	Not connected
Not connected	22	21	Not connected	Not connected	22	21	SDA
Not connected	24	23	GPIO5	Not connected	24	23	Not connected
Not connected	26	25	GPIO4	RESET_N	26	25	Not connected
Not connected	28	27	Not connected	MIC_BIAS	28	27	MIC_GND
Not connected	30	29	PWR_ON	Not connected	30	29	Not connected
GPIO3	32	31	GPIO2	Not connected	32	31	Not connected
HOST_SELECT1	34	33	GPIO1	SPK_N	34	33	SPK_P
V_INT	36	35	Not connected	Not connected	36	35	Not connected
Not connected	38	37	Not connected	Not connected	38	37	Not connected
Not connected	40	39	Not connected	Not connected	40	39	Not connected
GND	42	41	GND	GND	42	41	Not connected

Table 5: Pin-out of the 42-pin Dual-In-Line Board-to-Board connectors (J201, J200) available on the adapter board ADP-R2 of the EVK-R2 evaluation kit for TOBY-R2 series modules

 The pins / interfaces that are not supported by a specific TOBY-R2 module product version should be not driven by an external device (see the TOBY-R2 series Data Sheet [3] and the TOBY-R2 series System Integration Manual [5] for the features supported by each TOBY-R2 module product version).

1.6.2 EVK-R2 for LARA-R2 series modules

LARA-R2 series		DIL B2B	LARA-R2 series		DIL B2B	LARA-R2 series		DIL B2B
Pin N°	Name	Name / Pin N°	Pin N°	Name	Name / Pin N°	Pin N°	Name	Name / Pin N°
1	GND	J301 Pins 7-10	24	GPIO3	J301 Pin 32	47	SDIO_D0	J300 Pin 17
2	V_BCKP	J301 Pin 3	25	GPIO4	J301 Pin 25	48	SDIO_D3	J301 Pin 39
3	GND	J301 Pins 7-10	26	SDA	J300 Pin 21	49	SDIO_D1	J301 Pin 37
4	V_INT	J301 Pin 36	27	SCL	J300 Pin 20	50	GND	J301 Pins 7-10
5	GND	J301 Pins 7-10	28	USB_D-	Not present	51	VCC	J300 Pins 7-10
6	DSR	J301 Pin 18	29	USB_D+	Not present	52	VCC	J300 Pins 7-10
7	RI	J301 Pin 17	30	GND	J301 Pins 7-10	53	VCC	J300 Pins 7-10
8	DCD	J301 Pin 11	31	RSVD	Not present	54	GND	J301 Pins 7-10
9	DTR	J301 Pin 12	32	GND	J301 Pins 7-10	55	GND	J301 Pins 7-10
10	RTS	J301 Pin 13	33	RSVD	Not present	56	ANT1	Not present
11	CTS	J301 Pin 14	34	I2S_WA	Not present ⁴	57	GND	J301 Pins 7-10
12	TXD	J301 Pin 15	35	I2S_TXD	Not present ⁴	58	GND	J301 Pins 7-10
13	RXD	J301 Pin 16	36	I2S_CLK	Not present ⁴	59	ANT_DET	Not present
14	GND	J301 Pins 7-10	37	I2S_RXD	Not present ⁴	60	GND	J301 Pins 7-10
15	PWR_ON	J301 Pin 29	38	SIM_CLK	J300 Pin 15	61	GND	J301 Pins 7-10
16	GPIO1	J301 Pin 33	39	SIM_IO	J300 Pin 14	62	ANT2	Not present
17	VUSB_DET	Not present	40	SIM_RST	J300 Pin 16	63	GND	J301 Pins 7-10
18	RESET_N	J300 Pin 26	41	VSIM	J300 Pin 13	64	GND	J301 Pins 7-10
19	GPIO6	Not present ⁴	42	GPIO5	J301 Pin 23	65-96	GND	J301 Pins 7-10
20	GND	J301 Pins 7-10	43	GND	J301 Pins 7-10	97	RSVD	Not present
21	HOST_SELECT	J301 Pin 21	44	SDIO_D2	J301 Pin 30	98	RSVD	Not present
22	GND	J301 Pins 7-10	45	SDIO_CLK	J300 Pin 19	99	HSIC_DATA	Not present
23	GPIO2	J301 Pin 31	46	SDIO_CMD	J300 Pin 18	100	HSIC_STRB	Not present

Table 6: Interfaces of LARA-R2 series module, as routed on the 42-pin Dual-In-Line Board-to-Board connectors (J300, J301) available on the adapter board ADP-R2 of the EVK-R2 evaluation kit

⁴ OR jumper can be populated in order to route the signal to the 42-pin Dual-In-Line Board-to-Board connectors

DIL B2B J301				DIL B2B J300			
Signal Name	Pin N°	Pin N°	Signal Name	Signal Name	Pin N°	Pin N°	Signal Name
Not connected	2	1	GND	Not connected	2	1	GND
Not connected	4	3	V_BCKP	Not connected	4	3	Not connected
Not connected	6	5	Not connected	Not connected	6	5	Not connected
GND	8	7	GND	VCC	8	7	VCC
GND	10	9	GND	VCC	10	9	VCC
DTR	12	11	DCD	Not connected	12	11	Not connected
CTS	14	13	RTS	SIM_IO	14	13	VSIM
RXD	16	15	TXD	SIM_RST	16	15	SIM_CLK
DSR	18	17	RI	SDIO_CMD	18	17	SDIO_D0
Not connected	20	19	Not connected	SCL	20	19	SDIO_CLK
Not connected	22	21	HOST_SELECT	Not connected	22	21	SDA
Not connected	24	23	GPIO5	Not connected	24	23	Not connected
Not connected	26	25	GPIO4	RESET_N	26	25	Not connected
Not connected	28	27	Not connected	MIC_BIAS	28	27	MIC_GND
SDIO_D2	30	29	PWR_ON	Not connected	30	29	Not connected
GPIO3	32	31	GPIO2	Not connected	32	31	Not connected
Not connected	34	33	GPIO1	SPK_N	34	33	SPK_P
V_INT	36	35	Not connected	Not connected	36	35	Not connected
Not connected	38	37	SDIO_D1	Not connected	38	37	Not connected
Not connected	40	39	SDIO_D3	Not connected	40	39	Not connected
GND	42	41	GND	GND	42	41	Not connected

Table 7: Pin-out of the 42-pin Dual-In-Line Board-to-Board connectors (J301, J300) available on the adapter board ADP-R2 of the EVK-R2 evaluation kit for LARA-R2 series modules

 The pins / interfaces that are not supported by a specific LARA-R2 module product version should not be driven by an external device (see the LARA-R2 series Data Sheet [4] and the LARA-R2 series System Integration Manual [6] for the features supported by each LARA-R2 module product version).

1.7 Software installation

The USB drivers are available with the EVK-R2. Executable files can be downloaded from www.u-blox.com/evk-downloads and saved to any location on the computer hard drive. The installation can be started by running the executable file on a computer with the Windows operating system.

1.8 Board setup

1. Insert a SIM card into the **SIM card holder** (J300 on the EVB).
2. Connect a cellular antenna provided with the evaluation kit box to the **Primary cellular antenna** SMA connector on the ADP-R2 (ANT1, RF input/output for transmission and reception of LTE/3G/2G RF signals)
3. Connect a cellular antenna provided with the evaluation kit box to the **Secondary cellular antenna** SMA connector on the ADP-R2 (ANT2, RF input for the reception of the LTE RF signals as per

Down-Link Rx diversity). Place the secondary cellular antenna far enough from the primary cellular antenna (should be more than 20 cm).

4. If the GNSS functionality is required, connect the GNSS antenna provided with the evaluation kit box to the **GNSS antenna** SMA connector on the EVB. Place the GNSS antenna in a location with a good view of the sky.

 Since the interface to the GNSS module is not supported by LARA-R204-02B-00 / LARA-R211-02B-00 / TOBY-R200-02B-00 / TOBY-R202-02B-00 modules, the following changes are needed on the ADP-GNSS to appropriately provide supply to the GNSS:

- R106 = 0R, instead of not installed
 - R107 = Do not install, instead of 0R
5. Connect the AC / DC +12 V power adapter provided with the evaluation kit box to the **9 – 18 V Power Input** connector (J400 on the EVB). LED DL401 lights blue.
 6. Be sure to provide a jumper socket on the **Cellular VCC supply jumper** (J404 on the EVB). This provides the connection from the 3.8 V output of the supply circuit on the EVB to the VCC input of the module.
 7. To enable the board power supply, turn the **Main power switch** (SW400 on the EVB) to the ON position. LED DL400 lights green. The cellular module switches on.

 If the cellular module has been powered off by the AT+CPWROFF command, press the **Cellular Power-On** button (SW302 on EVB) or the **Cellular Reset** button (SW303 on EVB) to switch on the module again.

8. For communication via the cellular module's USB interface, connect a USB cable to the **Cellular native USB** connector (on ADP-R2). LED DS100 on ADP lights blue.

After the end of the module boot, the COM ports listed in [Table 8](#) are enabled by the Windows USB driver (details as the numbering of the ports can be seen via the Windows Device Manager)⁵:

Parameter	Type	Remarks
u-blox Modem USB1 AT and data	Modems	AT command interface and data communication
u-blox Modem USB2 AT and data	Ports (COM & LPT)	AT command interface and data communication
u-blox Modem USB3 AT and data	Ports (COM & LPT)	AT command interface and data communication
u-blox Modem USB4 GNSS	Ports (COM & LPT)	GNSS tunneling
u-blox Modem USB5 SAP	Ports (COM & LPT)	Remote SIM Access profile
u-blox Modem USB6 Primary Log	Ports (COM & LPT)	Diagnostic purpose

Table 8: Cellular USB interface configuration

Run an AT terminal application (e.g. the u-blox m-center tool) selecting an AT port, with these settings:

- Data rate: 115,200 bit/s
- Data bits: 8
- Parity: N
- Stop bits: 1
- Flow control: HW

See [Appendix A](#) for how to configure the u-blox m-center AT terminal for Windows.

⁵ A message of “driver installation fail” may appear on Windows if the USB cable has been connected before the end of the module boot, but this can be ignored as the normal operating functionality of the module will be available anyway after the end of the module boot.

9. For communication via the cellular module's UART interface, the following connections are allowed and can be alternatively enabled in a mutually exclusive way (see [Table 9](#) for the switch position and LED status):
 - a. Connect a USB cable to the mini USB connector (**Cellular USB**, J501 on EVB), LED DL501 lights blue
 - b. Connect an RS232 cable to the DB9 connector (**Cellular RS232**, J500 on EVB)

When a USB cable is connected to the mini USB connector, two COM ports are enabled in Windows (the numbering of the COM ports can be seen via the Windows Device Manager). The serial port for AT commands is available over the first numbered COM port opened by the driver.

Type of connections	SW401	SW403	LED
Access to cellular UART over the Cellular USB (UART) mini USB connector (J501)	ON BOARD	MINIUSB	DL403
Access to cellular UART over the Cellular RS232 (UART) DB9 connector (J500)	ON BOARD	DB9	DL405
Access to cellular UART on the DIL Board-to-Board connector on the adapter board: cellular UART detached from USB (UART) J501 and RS232 (UART) J500 connectors	B2B	Do not care	DL404

Table 9: Serial interface configuration

Run an AT terminal application (e.g. the u-blox m-center tool) selecting an AT port, with these settings:

- Data rate: 115,200 bit/s
- Data bits: 8
- Parity: N
- Stop bits: 1
- Flow control: HW

See [Appendix A](#) for how to configure the u-blox m-center AT terminal for Windows.

10. If the audio functionality is required, connect the headset provided with the evaluation kit box to the **Headset jack** connector (J303 on EVB).



Audio is not supported by LARA-R204-02B and LARA-R220-62B product versions.

1.9 Enabling error result codes

Command sent by DTE (user)	DCE response (module)	Description
AT+CMEE=2	OK	Enables the cellular module to report verbose error result codes.

1.10 PIN code insertion (when required)

Command sent by DTE (user)	DCE response (module)	Description
AT+CPIN="8180"	OK	Enter the PIN code, if needed (enter the PIN of the SIM card – 8180 is written here as an example).
AT+CLCK="SC", 0, "8180"	OK	Unlock the PIN at power-on (the last parameter is the PIN of the SIM card – 8180 is written here as an example).
AT+CLCK="SC", 1, "8180"	OK	Lock the PIN at power-on (the last parameter is the PIN of the SIM card – 8180 is written here as an example).

1.11 Registration on a cellular network

Command sent by DTE (user)	DCE response (module)	Description
AT+CREG?	+CREG: 0,1 OK	Verify the network registration.
AT+COPS=0	OK	Register the module on the network. The cellular module automatically registers itself on the cellular network. This command is necessary only if the automatic registration failed (AT+CREG? returns 0,0).
AT+COPS?	+COPS: 0,0,"I TIM",7 OK	Read the operator name and radio access technology (RAT).

For further AT command examples regarding Mobile Network Operator, Radio Access Technology, and band selection and configuration, see the u-blox AT Commands Examples Application Note [\[2\]](#).

1.12 Enable audio codec configuration to provide voice capability

Command sent by DTE (user)	DCE response (module)	Description
AT+UGPIOC?	TOBY-R2 case: LARA-R2 case: +UGPIOC: +UGPIOC: 21,255 16,255 22,255 23,255 24,255 24,255 25,0 25,0 50,12 34,12 51,12 35,12 52,12 36,12 53,12 37,12 60,7 42,7 OK OK	Check the configuration of I2S pins (<gpio_id> = 50, 51, 52, 53 for TOBY-R2, <gpio_id> = 34, 35, 36, 37 for LARA-R2): they must be configured as I2S digital audio interface (<gpio_mode> = 12, as the factory-programmed value) to provide voice capability at the headset jack connector using the external audio codec mounted on the EVK-R2.
AT+USPM?	+USPM: 1,1,0,0,2 OK	Check the audio path mode setting: both the up-link and the down-link paths need to be configured as I2S digital audio interfaces (e.g. <main_uplink> = 1, <main_downlink> = 1, as the factory-programmed value) to provide voice capability at the headset jack connector using the external audio codec mounted on the EVK-R2.
AT+UEXTDCONF=0,1	OK	Enable the automatic configuration of the external Maxim MAX9860 audio codec mounted on the EVK-R2. The setting is saved in the non-volatile memory (NVM) and it is applied at each subsequent module power-on.
AT+CPWROFF	OK	Switch off the EVK-R2. The external Maxim MAX9860 audio codec mounted on the EVK-R2 will be fed by the 13 MHz master clock provided by the GPIO6 and it will be dynamically programmed over the I ² C interface at any subsequent re-boot of the module and every time the audio path is enabled, providing voice capability at the headset jack connector of the EVK-R2.

1.13 Switching off the EVK-R2

To switch off the EVK-R2, send the +CPWROFF AT command. Make sure to use this command before switching off the main power, otherwise settings and configuration parameters may not be saved in the internal non-volatile memory of the cellular module.

B Setting up cellular packet data connection on PC

This section describes how to set up a packet data connection with the Windows 7 operating systems (for PC) and EVK-R2, using the TCP/IP stack of the PC (external TCP/IP stack).

The following examples describe how to install and configure two different kinds of modem on Windows:

1. Low data rate modem, over the UART interface of the cellular module connected to the Windows PC by the **Cellular USB** connector (J501 on EVB) or the **Cellular RS232** connector (J500 on EVB)
2. High data rate modem, over the native USB interface of the cellular module connected to the Windows PC by the **Cellular Native USB** connector on the ADP

B.1 How to install and configure a low data rate modem connection

This example describes how to install and configure a low data rate packet data connection on a PC with the Windows 7 operating system. This uses the TCP/IP stack of the PC over the UART interface of the cellular module connected to the Windows PC by the **Cellular USB** connector (J501 on EVB) or the **Cellular RS232** connector (J500 on EVB).

1. Follow the board setup instructions in section 1.8 to provide the required connections with EVK-R2.

2. Select “Control panel > Phones and Modem > Modems > Add”. This opens the Install New Modem Wizard.
3. Select the **Don't detect my modem** checkbox.

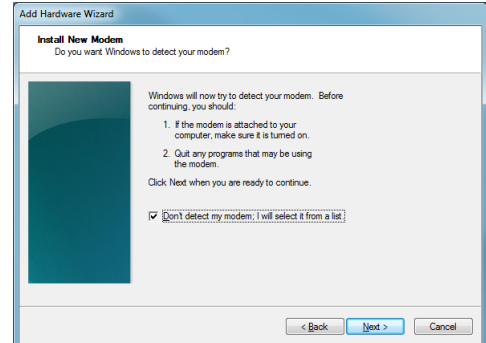

4. Select the Standard Modem (33,600 bit/s).

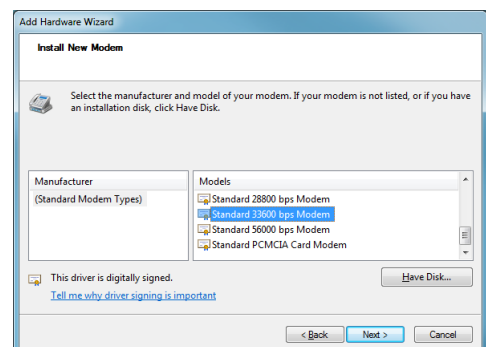

5. Set the COM port on which the modem will be installed.

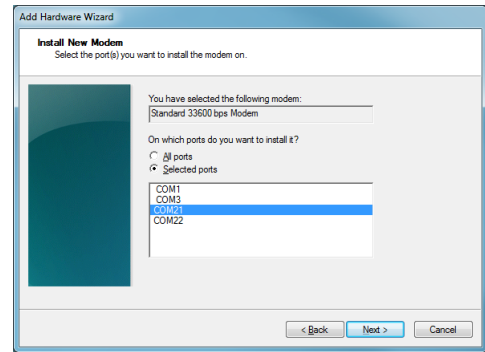

6. Select “Control panel > Phones and Modem > Modems > Standard Modem 33,600 bps Modem > Properties”.
7. Select “Change Settings > Advanced”.
8. Add APN settings command (APN shown is just an example. Make sure to have the correct APN defined by the network operator).
9. Click on **Change Default Preferences**.

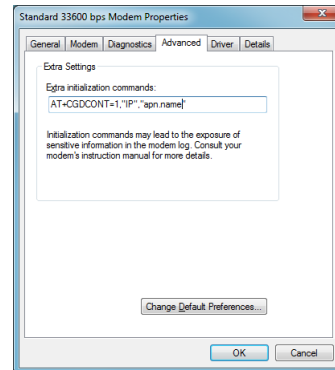

10. Click on **OK** twice and the new connection is now ready to be configured.

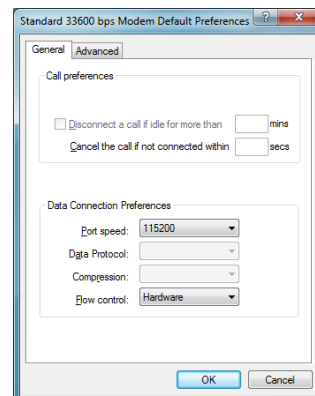

11. To configure a new connection, select “Control Panel > Network and Sharing Center > Set up a new connection or network”.

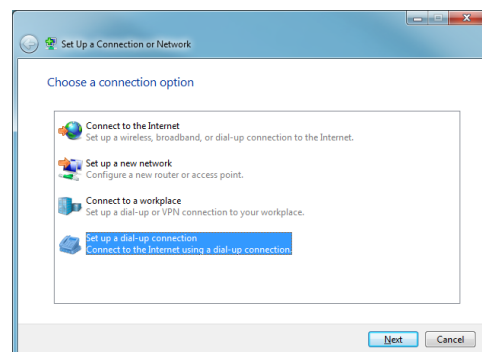

12. Select the modem, if requested (the question appears only if more than one modem is available).

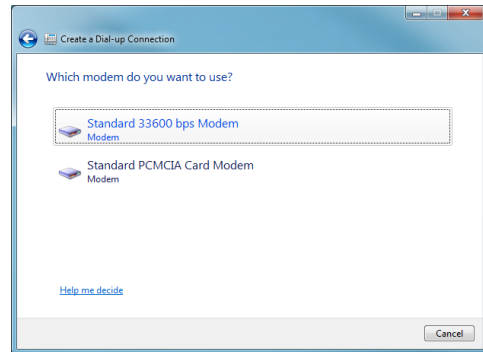

13. Enter parameters for dial-up connection:

- The module telephone number (*99***1#)
- The specific GPRS account information for the network operator
- A name for the new connection (e.g. “u-blox GPRS Connection”)

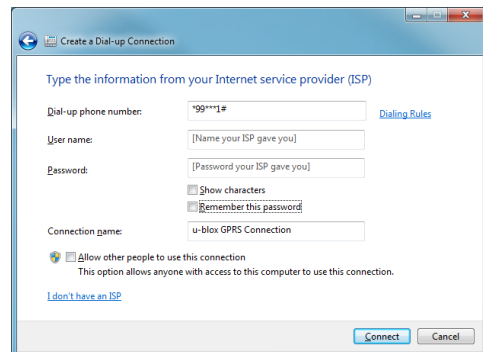

14. The packet data connection is now ready to be used with the EVK-R2. To check the connection, start a browser.



- Consult the cellular network operator for the username and password. In most cases, these can be left empty.

B.2 How to install and configure a high data rate modem connection

This example describes how to install and configure a high data rate packet data connection on a PC with the Windows 7 operating system, using the TCP/IP stack of the PC, over the native USB interface of the cellular module connected to the Windows PC by the **Cellular Native USB** connector on the ADP.

1. Follow the board setup instructions in section 1.8 to provide the required connections with EVK-R2.

2. Select: "Control Panel > Network and Internet > Network and Sharing Center > Setup a new connection or network"
This opens the "Choose a connection option" Wizard.

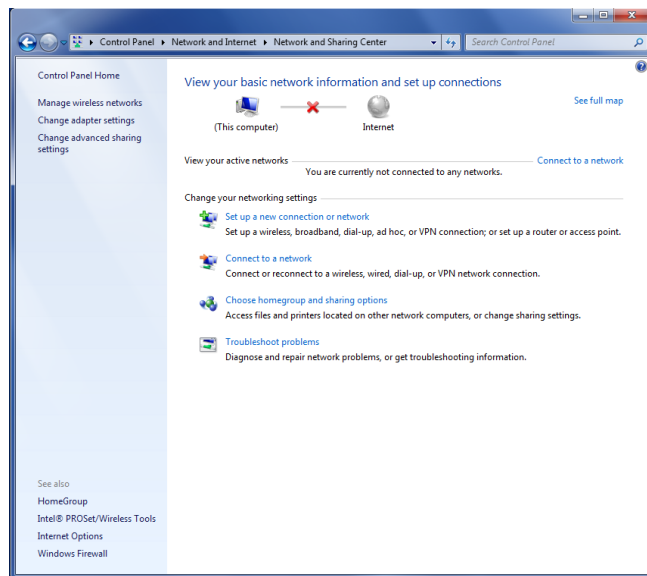

3. Select **Set up a dial-up connection**. Click on **Next**.

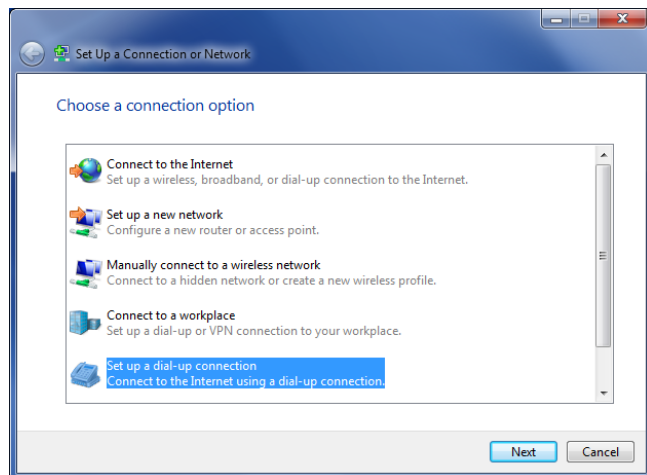

4. Select **u-blox Modem USB1 AT and Data #X** (X=7 in the picture).

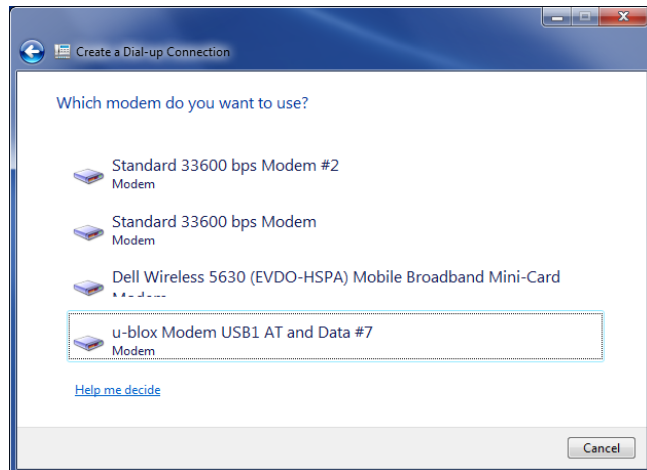

5. Enter the modem telephone number (*99***1#), select **Allow other people to use this connection** and click **Connect** to finalize the procedure.

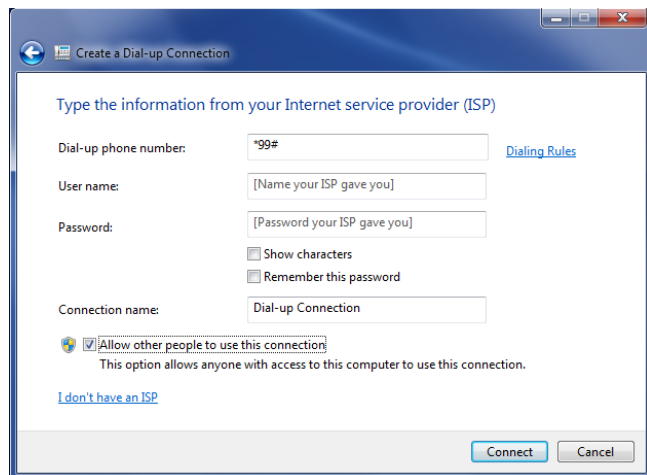

-  Consult the cellular network operator for the username and password. In most cases, these can be left empty.

C Examples of AT commands

For the complete description and syntax of the AT commands supported by each TOBY-R2 and LARA-R2 series cellular module product version, see the u-blox AT commands Manual [1].

For detailed examples of AT commands for network registration and configuration, context activation, data connection management, SIM management, module interfaces configurations and other settings, see the u-blox AT Commands Examples Application Note [2].

C.1 Define the initial default bearer for connectivity

To change the PDN settings for the initial default EPS bearer established during LTE attach, edit the <cid>=1 PDN by means of the AT+CGDCONT AT command.

Command sent by DTE (user)	DCE response (module)	Description
AT+COPS?	+COPS: 2 OK	Module is not registered.
AT+CREG=2;+CGREG=2;+CEREG=2;+CGERE P=1,1;+CIREG=1	OK	Enable a set of registration URC, including PS, CS, EPS and IMS registration events.
AT+CGDCONT?	+CGDCONT: 1,"IPV4V6","", "",0,0 OK	Read IP type and APN for EPS attach bearer.
AT+CGDCONT=1,"IPV4V6","broadband"	OK	Set APN name (i.e. "broadband") and the PDP type (i.e. "IPV4V6") for EPS attach bearer.
AT+COPS=0	OK +CGEV: NW CLASS A +CREG: 1,"7CFF","00051235",6 +CGREG: 1,"7CFF","00051235",6,"F" F" +CEREG: 1,"8305","04C87A0F",7 +CGEV: ME PDN ACT 1	Trigger registration and wait for LTE attach complete.
ATD*99***1#	CONNECT	Establish a PPP/dialup data session.

D Current consumption measurement

The current consumption of TOBY-R2 or LARA-R2 series modules can be measured on the EVK-R2 by removing the jumper socket from the **Cellular VCC supply jumper** (J404 on the EVB), described in [Figure 6](#).

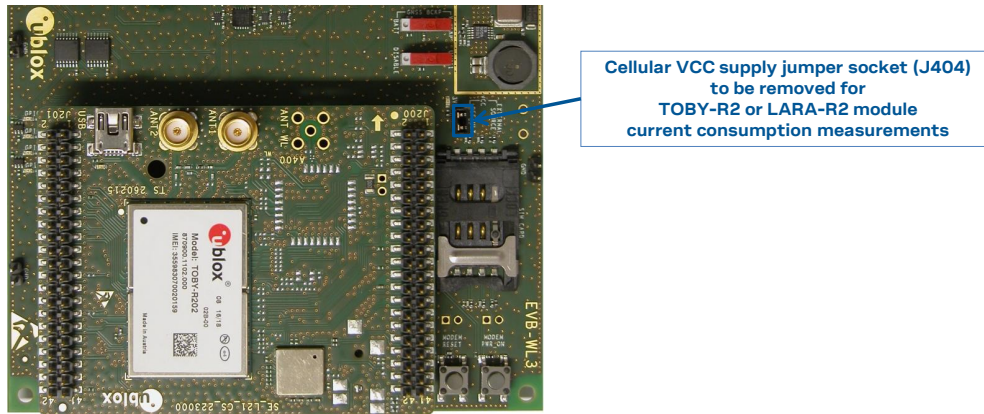

Figure 6: Jumper socket to be removed for TOBY-R2 or LARA-R2 series modules current consumption measurement

A suitable external digital multi-meter (as for example the Agilent 34410A or 34411A) can be used for current consumption measurements: in this case, the 3.8 V supply circuit on the EVB will supply the TOBY-R2 or LARA-R2 module mounted on the adapter board, with the digital multi-meter placed in series as illustrated in [Figure 7](#).

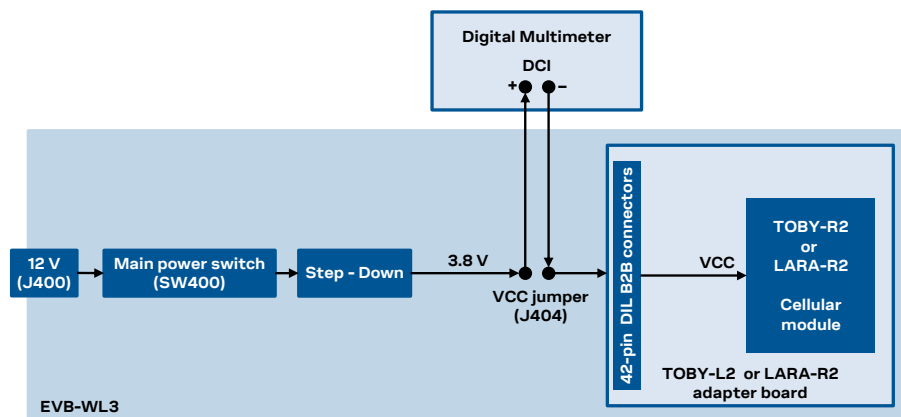

Figure 7: Block diagram of current consumption setup for TOBY-R2 or LARA-R2 series modules

Alternatively, a suitable external DC power supply with the dynamic current measurement capabilities (as for example, the Agilent 66319B/D) can be used for current consumption measurements, acting also as the 3.8 V supply source for the TOBY-R2 or LARA-R2 module mounted on the adapter board.

E Glossary

Abbreviation	Definition
ADP	Adapter Board
APN	Access Point Name
AT	AT Command Interpreter Software Subsystem, or attention
B2B	Board-To-Board
CS	Circuit Switched
CTS	Clear To Send
DDC	Display Data Channel
DIL	Dual In Line
EPS	Evolved Packet System
EVB	Evaluation Board
EVK	Evaluation Kit
GND	Ground
GNSS	Global Navigation Satellite System
GPIO	General Purpose Input Output
GPRS	General Packet Radio Service
IMS	IP Multimedia Subsystem
IP	Internet Protocol
LDO	Low Drop-Out
LED	Light Emitting Diode
LTE	Long Term Evolution
NVM	Non-Volatile Memory
PIN	Personal Identification Number
PS	Packet Switch
RAT	Radio Access Technology
RF	Radio Frequency
RI	Ring Indicator
SIM	Subscriber Identity Module
TCP	Transfer Control Protocol
UART	Universal Asynchronous Receiver-Transmitter
URC	Unsolicited Result Code
USB	Universal Serial Bus
VCC	Voltage Common Collector

Table 10: Explanation of the abbreviations and terms used

F Declaration of conformities

The equipment is intended for indoor usage. It is the user's duty to verify if further restrictions apply, such as in airplanes, hospitals or hazardous locations (petrol stations, refineries...).

Any changes or modification made to this equipment will void its compliance to the safety requirements.

Maintenance, inspections and/or repairs of the EVK-R2 shall be performed by u-blox AG.

Related documents

- [1] u-blox AT commands manual, Doc. No. [UBX-13002752](#)
- [2] u-blox AT Commands Examples Application Note, Doc. No. [UBX-13001820](#)
- [3] u-blox TOBY-R2 series Data Sheet, Doc. No. [UBX-16005785](#)
- [4] u-blox LARA-R2 series Data Sheet, Doc. No. [UBX-16005783](#)
- [5] u-blox TOBY-R2 series System Integration Manual, Doc. No. [UBX-16010572](#)
- [6] u-blox LARA-R2 series System Integration Manual, Doc. No. [UBX-16010573](#)

 For regular updates to u-blox documentation and to receive product change notifications, register on our homepage (www.u-blox.com).

Revision history

Revision	Date	Name	Comments
R01	15-Jul-2016	sses	Initial release
R02	23-Sep-2016	sses	Updated status to Advance Information Corrected external audio codec configuration example
R03	23-Dec-2016	sses	"Disclosure restriction" replaces "Document status" on page 2 and document footer Updated document applicability to EVK-R200, EVK-R202, EVK-R204 and EVK-R211 evaluation kits with Engineering Sample product status
R04	02-Mar-2017	lpah	Updated IP FW version of EVK-R200-00B-00 / EVK-R202-00B-00
R05	17-Mar-2017	sses	Extended document applicability to EVK-R203
R06	19-Apr-2017	lpah	Updated IP FW version of EVK-R204-00B-00 / EVK-R211-00B-00
R07	30-Jun-2017	lpah	Added EVK-R220 and EVK-R280; Updated status of EVK-R203; Added note about GNSS interface not available
R08	20-Oct-2017	lpah	Updated FW version of EVK-R203, EVK-R220, EVK-R280
R09	18-Dec-2017	lpah	Updated EVK-R280 product status
R10	01-Jul-2019	lpah	Updated EVK-R2 product status