



# EVK-R5

## SARA-R5 series cellular evaluation kits

### User guide



#### **Abstract**

This guide explains how to set up the EVK-R5 evaluation kits to begin evaluating the u-blox SARA-R5 series modules supporting multi-band LTE-M / NB-IoT cellular radio access technology and the u-blox's leading GNSS technology.

# Document information

<b>Title</b>	<b>EVK-R5</b>	
<b>Subtitle</b>	SARA-R5 series cellular evaluation kits	
<b>Document type</b>	User guide	
<b>Document number</b>	UBX-19042592	
<b>Revision and date</b>	R13	21-Jun-2023
<b>Disclosure restriction</b>	C1-Public	

<b>Product status</b>	<b>Corresponding content status</b>	
<b>Functional sample</b>	Draft	For functional testing. Revised and supplementary data will be published later.
<b>In development / Prototype</b>	Objective specification	Target values. Revised and supplementary data will be published later.
<b>Engineering sample</b>	Advance information	Data based on early testing. Revised and supplementary data will be published later.
<b>Initial production</b>	Early production information	Data from product verification. Revised and supplementary data may be published later.
<b>Mass production / End of life</b>	Production information	Document contains the final product specification.

This document applies to the following products:

<b>Product name</b>	<b>Type number</b>
EVK-R500S	EVK-R500S-1-00
	EVK-R500S-6-00
	EVK-R500S-7-00
EVK-R510S	EVK-R510S-1-00
	EVK-R510S-6-00
	EVK-R510S-7-00
EVK-R510M8S	EVK-R510M8S-1-00
	EVK-R510M8S-6-00
	EVK-R510M8S-7-00
EVK-R510AWS	EVK-R510AWS-01-00
EVK-SARA-R500E	EVK-SARA-R500E-01-00

u-blox or third parties may hold intellectual property rights in the products, names, logos and designs included in this document. Copying, reproduction, modification or disclosure to third parties of this document or any part thereof is only permitted with the express written permission of u-blox.

The information contained herein is provided "as is" and u-blox assumes no liability for its use. No warranty, either express or implied, is given, including but not limited to, with respect to the accuracy, correctness, reliability and fitness for a particular purpose of the information. This document may be revised by u-blox at any time without notice. For the most recent documents, visit [www.u-blox.com](http://www.u-blox.com).

Copyright © u-blox AG.

# Contents

Document information.....	2
Contents .....	3
1 Starting up.....	4
Appendix .....	14
A Setting up AT terminal communication.....	14
B Setting up cellular packet data connection on Windows.....	15
C AT commands examples .....	18
D Current consumption measurement.....	22
E Declaration of conformities.....	23
F Glossary .....	24
Related documentation .....	25
Revision history .....	25
Contact.....	25

# 1 Starting up

## 1.1 Overview

The EVK-R5 kit is a powerful and easy-to-use tool that simplifies the evaluation of the u-blox SARA-R5 series LTE-M / NB-IoT cellular modules.

The following evaluation kits are available with u-blox SARA-R5 cellular modules:

- EVK-R500S evaluation kit is for evaluation of SARA-R500S modules, including
  - EVK-R500S-1 evaluation kit for evaluation of SARA-R500S-01B module product version
  - EVK-R500S-6 evaluation kit for evaluation of SARA-R500S-61B module product version
  - EVK-R500S-7 evaluation kit for evaluation of SARA-R500S-71B module product version
- EVK-R510S evaluation kit is for evaluation of SARA-R510S modules, including
  - EVK-R510S-1 evaluation kit for evaluation of SARA-R510S-01B module product version
  - EVK-R510S-6 evaluation kit for evaluation of SARA-R510S-61B module product version
  - EVK-R510S-7 evaluation kit for evaluation of SARA-R510S-71B module product version
- EVK-R510M8S evaluation kit is for evaluation of SARA-R510M8S modules, including
  - EVK-R510M8S-1 evaluation kit for evaluation of SARA-R510M8S-01B module product version
  - EVK-R510M8S-6 evaluation kit for evaluation of SARA-R510M8S-61B module product version
  - EVK-R510M8S-7 evaluation kit for evaluation of SARA-R510M8S-71B module product version
- EVK-R510AWS evaluation kit is for evaluation of SARA-R510AWS module
- EVK-SARA-R500E evaluation kit is for evaluation of SARA-R500E module

All evaluation kits are referred to as the EVK-R5, as they are the same in the related variants / versions, except for the specific module product version installed on it, with possible related parts.

The different variants / versions of the EVK-R5 evaluation kit reflect the available variants / versions of the SARA-R5 series modules, including the following 4 modules:

- SARA-R500S, cost effective solution where ultra-low consumption / GNSS are not needed
- SARA-R510S, designed to achieve extremely low current consumption in PSM/eDRX deep-sleep
- SARA-R510M8S, integrating the u-blox M8 high performance concurrent GNSS chip
- SARA-R510AWS, AWS IoT ExpressLink designed to achieve extremely low current consumption in power-off/deep-sleep state
- SARA-R500E, module with integrated SIM and bundled connectivity for the North America region

and the following 3 products versions are available for SARA-R500S, SARA-R510S and SARA-R510M8S modules:

- “01B” products version designed for use in multi-regions
- “61B” products version designed for use in Japan
- “71B” products version designed for use in Korea

 See the SARA-R5 series data sheets [\[2\]](#), [\[3\]](#) and the SARA-R5 series system integration manual [\[4\]](#) for features supported by each SARA-R5 series module product version.

Figure 1 illustrates the main parts, connectors, switches, jumpers, buttons, LEDs of the EVK-R5 evaluation kit for SARA-R5 series modules.

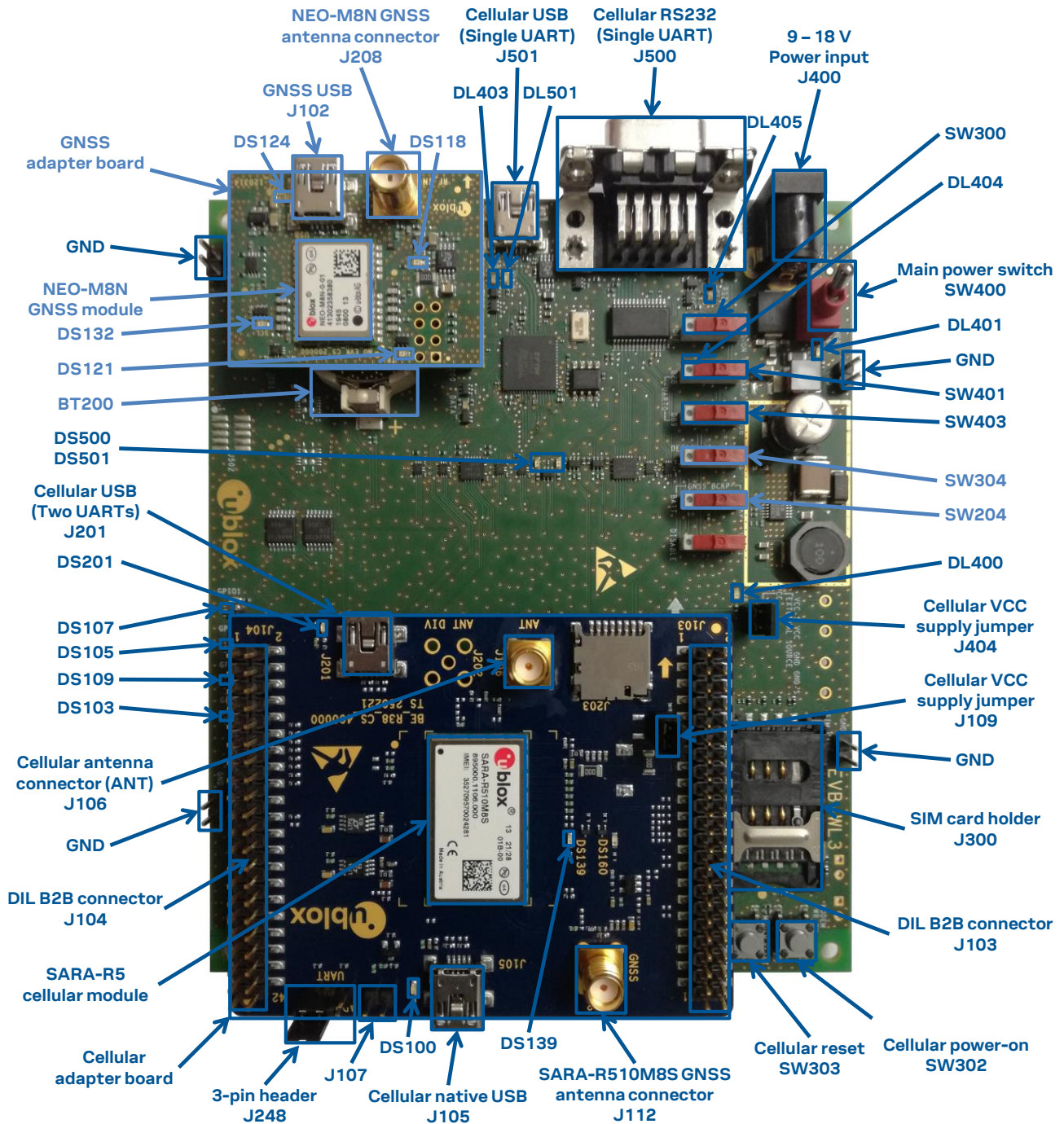

Figure 1: Overview of EVK-R5 evaluation kit

## 1.2 Block diagram

Figure 2 shows the main interfaces and internal connections of the EVK-R5 evaluation kit:

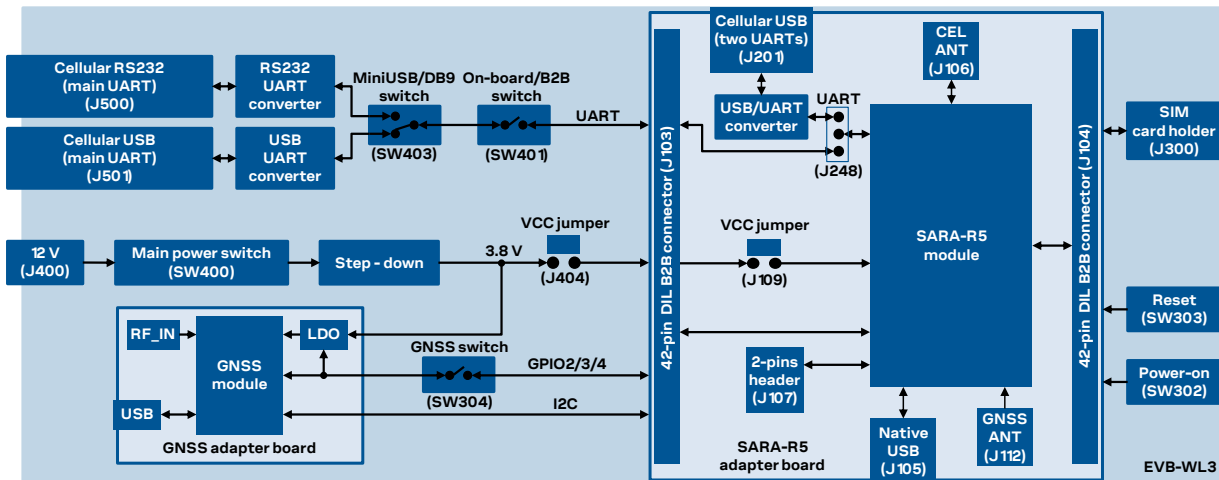

Figure 2: Block diagram of the EVK-R5 for SARA-R5 series modules

The EVK-R5 evaluation kit is formed by three boards:

1. The lower one, called EVB-WL3, contains the power supply and other peripherals for the u-blox SARA-R5 series cellular module (such as SIM card holder, reset button and power-on button).
2. The cellular adapter board, called ADP-R5, contains the u-blox SARA-R5 cellular module and connectors to access the cellular module interfaces. There are antenna connectors for the cellular RF interface and the GNSS RF interface of the cellular module, USB connectors for the two UART interfaces and the USB interface of the cellular module, the DIL header connectors (J103 and J104), and the 2-pins header connector (J107).
3. The GNSS adapter board, called ADP-GNSS, contains the u-blox NEO-M8N GNSS module, the GNSS antenna connector, and the USB connector for the u-blox NEO-M8N GNSS module.

The cellular and the GNSS adapter boards are connected by male header board-to-board connectors provided on the bottom of the adapter boards and their corresponding female connectors provided on top of the EVB-WL3 board.

If the on-board / B2B switch (SW401) on the EVB-WL3 board is set to “on-board” and if a jumper socket is inserted on the pin 1 and pin 2 of the 3-pin header J248 on the cellular adapter board (see Figure 3), then the main UART interface of the cellular module, routed through the DIL header board-to-board connectors mounted on the bottom of the cellular adapter board, can be accessed as converted to USB interface on the USB connector (J501) on the EVB-WL3 board, or it can be accessed as converted to RS232 interface on the RS232 DB9 connector (J500) on the EVB-WL3 board, according to the mini-USB / DB9 switch (SW403) setting.

If the on-board / B2B switch (SW401) on the EVB-WL3 board is set to “B2B” and if a jumper socket is inserted on the pin 2 and pin 3 of the 3-pin header cellular UART jumper (J248) on the adapter board (illustrated in Figure 3), the UART interfaces of SARA-R5 series module can be accessed as USB interfaces on the USB connector (J201) on the cellular adapter board.

If the on-board / B2B switch (SW401) on the EVB-WL3 board is set to “B2B” and if there is no jumper socket inserted on the 3-pin header J248 on the cellular adapter board (illustrated in Figure 3), then the UART interface(s) of the SARA-R5 module can be accessed at 1.8 V CMOS signal levels on the DIL header connector mounted on the top of the cellular adapter board, to communicate, for example, with an external MCU.

The USB interface of the cellular module (available for diagnostic purpose only) is available on the native USB connector (J105) mounted on the cellular adapter board.



Other SARA-R5 series peripherals are available on the dual-in-line male board-to-board connectors (J103, and J104) and the 2-pins header connector (J107) provided on the top layer of the cellular adapter board.

The lower board (EVB-WL3) is also designed to be used with other u-blox cellular adapter boards. It contains additional switches, jumpers, connectors, LEDs and parts that may be only partially described in [Figure 1](#) or in this document, because they are intended for use only with other u-blox cellular modules. It is recommended to leave any additional connector unconnected and any additional switch in its default configuration.

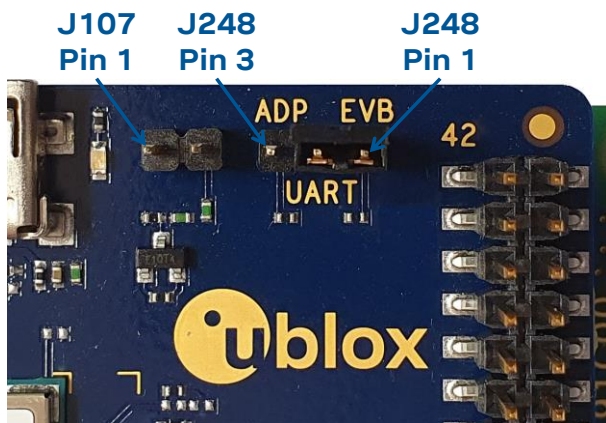

Figure 3: 3-pin header J248 available to set the routing of the UART interfaces on the EVK for SARA-R5 series modules















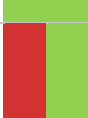



### 1.3 Switches, jumpers, and buttons

Function	Description	Name	Board
Main power switch	Power on / off the whole evaluation kit	SW400	EVB-WL3
Cellular VCC jumper	Jumper socket to provide the 3.8 V supply to the cellular module VCC input	J404	EVB-WL3
		J109	ADP-R5
Cellular power on	Push button to switch on / off the cellular module	SW302	EVB-WL3
Cellular reset	Push button to reset the cellular module	SW303	EVB-WL3
Cellular UART detach	Slide switch to attach / detach the cellular module main UART from the USB / RS232 connectors on EVB-WL3	SW401	EVB-WL3
Cellular UART routing	Slide switch to select cellular module main UART routing on the USB or RS232 connector on EVB-WL3	SW403	EVB-WL3
Cellular UART routing	3-pin header to route and make accessible the UART(s) of SARA-R5 series over the USB connector on the ADP board, or over the USB or RS232 connectors on the EVB-WL3, or over the DIL B2B connector on the ADP board	J248	ADP-R5
Cellular GPIO detach	Slide switch to attach / detach the cellular module GPIOs from peripherals: when detached, the signals are available only on the DIL B2B connector on the ADP board	SW300	EVB-WL3
Cellular GNSS detach <sup>1</sup>	Slide switch to attach / detach the cellular module to / from the GNSS module (GPIO2-3-4): when detached, the signals are available only on the DIL B2B connector on the ADP board	SW304	EVB-WL3
GNSS V_BCKP	Slide switch to connect / disconnect backup battery to / from the V_BCKP pin of the GNSS module	SW204	EVB-WL3

Table 1: EVK-R5 switch and button descriptions

<sup>1</sup> For EVK-R510M8S it is recommended to keep this switch in “detach” position.

## 1.4 LEDs

Function	Description	LED #	Board	Color
Main power	Power supply plugged in the <b>9 - 18 V Power Input</b>	DL401	EVB-WL3	
Cellular VCC	Cellular module supplied. <b>Main power switch</b> must be switched on.	DL400	EVB-WL3	
Cellular USB (main UART)	USB cable plugged in the <b>Cellular USB</b> connector (J501) for access to the main UART interface of the cellular module	DL501	EVB-WL3	
Cellular USB (main UART)	Green light is on when the SW401 is in “on-board” position, and when the cellular module main UART is routed to the <b>Cellular USB</b> connector. Red light blinks at UART TX or RX data on the <b>Cellular USB</b> connector.	DL403	EVB-WL3	
Cellular main UART attach/detach	UART signals of the cellular module are available only on the ADP board.	DL404	EVB-WL3	
Cellular RS232 (main UART)	Green light is on when the main UART of the cellular module is routed to the <b>Cellular RS232</b> connector (J500). Red light blinks at UART TX or RX data on the <b>Cellular RS232</b> connector.	DL405	EVB-WL3	
Cellular RI indicator	RI line turns ON (active low)	DS501	EVB-WL3	
Cellular CTS indicator	CTS line turns ON (active low)	DS500	EVB-WL3	
Cellular GPIO1 indicator	Green light is activated when cellular GPIO1 is high	DS107	EVB-WL3	
Cellular GPIO2 indicator	Green light is activated when cellular GPIO2 is high	DS105	EVB-WL3	
Cellular GPIO3 indicator	Green light is activated when cellular GPIO3 is high	DS109	EVB-WL3	
Cellular GPIO4 indicator	Green light is activated when cellular GPIO4 is high	DS103	EVB-WL3	
Cellular GPIO6 indicator	Green light is activated when cellular GPIO6 is high, e.g., to be used for time pulse function	DS139	ADP-R5	
Cellular native USB	USB cable plugged in the <b>Cellular native USB</b> connector (J105) on the ADP-R5, for access to the cellular USB interface	DS100	ADP-R5	
Cellular USB (two UARTs)	USB cable plugged in the <b>Cellular USB</b> connector (J201) on the ADP-R5, for access to the two UART interfaces	DS201	ADP-R5	
GNSS VCC supply	NEO-M8N GNSS module supply is turned on	DS118	ADP-GNSS	
GNSS USB	USB cable plugged into the <b>GNSS USB</b> connector for NEO-M8N	DS124	ADP-GNSS	
NEO GNSS time pulse	NEO-M8N GNSS TimePulse output	DS121	ADP-GNSS	
Cellular / GNSS I2C	Cellular / GNSS module communication over the I2C interface	DS132	ADP-GNSS	



**Table 2: EVK-R5 LED descriptions**



## 1.5 Connectors

Function	Description		Name	Board	
9 - 18 V power input	Connector for the AC / DC power adapter of EVK AC: 100-240 V, 0.8 A, 50-60 Hz / DC: +12 V, 2.5 A		IEC 60417-5172 Class II equipment	J400	EVB-WL3
SIM card holder	SIM card holder			J300	EVB-WL3
Cellular USB (main UART)	Mini-USB connector for the cellular module main UART interface converted as a USB interface			J501	EVB-WL3
Cellular RS232 (main UART)	DB9 connector for the cellular module main UART interface converted as an RS232 interface			J500	EVB-WL3
GNSS backup battery	Backup battery socket for the GNSS module (under GNSS adapter board)			BT200	EVB-WL3
GND	Ground terminals for the probe reference			J402, J403 J405, J406	EVB-WL3
Cellular antenna	SMA connector for the module cellular antenna (ANT)			J106	ADP-R5
GNSS antenna (for SARA-R510M8S)	SMA connector for the GNSS antenna to be connected to the GNSS RF input of the SARA-R510M8S module (ANT_GNSS)			J112	ADP-R5
Cellular native USB	Mini-USB connector for the cellular module native USB interface			J105	ADP-R5
Cellular USB (two UARTs)	Mini-USB connector for the cellular module two UART interfaces converted as USB interfaces			J201	ADP-R5
DIL B2B headers	Dual-in-line board-to-board connectors for cellular module interfaces			J103, J104	ADP-R5
2-pin header	Header providing access to EXT_INT and V_INT pins of the cellular module			J107	ADP-R5
GNSS antenna (for NEO-M8N)	SMA connector for the GNSS antenna to be connected to the GNSS RF input of the NEO-M8N GNSS module (RF_IN)			J208	ADP-GNSS
GNSS USB	Mini-USB connector for the GNSS module USB interface			J102	ADP-GNSS

**Table 3: EVK-R5 connector descriptions**

-  Caution! In the unlikely event of a failure in the internal protection circuitry, there is a risk of an explosion when charging a fully or a partially discharged battery. Replace the battery when it no longer has sufficient charge for unit operation. Check the battery before use if the device has not been used for an extended period.
-  Caution! Risk of explosion if the battery is replaced with an incorrect type. Dispose of used batteries according to the instructions.

## 1.6 Pin-out

Table 4 lists the interfaces of the SARA-R5 series modules, as routed up to the 42-pin dual-in-line board-to-board connectors J103 and J104, the 2-pin header connector J107, the mini USB connector J105, the micro SD card connector J203 or the SMA connectors J106 and J112 available on the ADP-R5 adapter board of the evaluation kit.

SARA-R5 module			SARA-R5 module		
Pin no.	Signal name	Connector Name / pin number	Pin no.	Signal name	Connector Name / pin number
1	GND	J104 pins 7-10	33	EXT_INT	J107 pin 2
2	RSVD	J104 pin 4	34	I2S_WA	J103 pin 26
3	GND	J104 pins 7-10	35	I2S_TXD	J103 pin 23
4	V_INT	J104 pin 35, J107 pin 1	36	I2S_CLK	J103 pin 21
5	GND	J104 pins 7-10	37	I2S_RXD	J103 pin 24
6	DSR	J104 pin 17	38	SIM_CLK	J103 pin 16
7	RI	J104 pin 18	39	SIM_IO	J103 pin 13
8	DCD	J104 pin 12	40	SIM_RST	J103 pin 15
9	DTR	J104 pin 11	41	VSIM	J103 pin 14
10	RTS	J104 pin 14	42	GPIO5	J104 pin 24
11	CTS	J104 pin 13	43	GND	J104 pins 7-10
12	TXD	J104 pin 16	44	SDIO_D2	J203 pin 1
13	RXD	J104 pin 15	45	SDIO_CLK	J203 pin 5
14	GND	J104 pins 7-10	46	SDIO_CMD	J203 pin 3
15	PWR_ON	J104 pin 30	47	SDIO_D0	J203 pin 7
16	GPIO1	J104 pin 34	48	SDIO_D3	J203 pin 2
17	VUSB_DET	J105 pin 1	49	SDIO_D1	J203 pin 8
18	RESET_N	J103 pin 25	50	GND	J104 pins 7-10
19	GPIO6	J104 pin 23	51	VCC	J103 pins 7-10
20	GND	J104 pins 7-10	52	VCC	J103 pins 7-10
21	ADC	J104 pin 22	53	VCC	J103 pins 7-10
22	GND	J104 pins 7-10	54	GND	J104 pins 7-10
23	GPIO2	J104 pin 32	55	GND	J104 pins 7-10
24	GPIO3	J104 pin 31	56	ANT	J106 pin 1
25	GPIO4	J104 pin 26	57	GND	J104 pins 7-10
26	SDA	J103 pin 22	58	GND	J104 pins 7-10
27	SCL	J103 pin 19	59	GND	J104 pins 7-10
28	USB_D-	J105 pin 2	60	GND	J104 pins 7-10
29	USB_D+	J105 pin 3	61	GND	J104 pins 7-10
30	GND	J104 pins 7-10	62	ANT_DET	J106 pin 1
31	ANT_GNSS	J112 pin 1	63	GND	J104 pins 7-10
32	GND	J104 pins 7-10	64	GND	J104 pins 7-10

**Table 4: Interfaces of the SARA-R5 series modules**

Dual-In-Line Board-to-Board connector J104				Dual-In-Line Board-to-Board connector J103			
Signal name	Pin no.	Pin no.	Signal name	Signal name	Pin no.	Pin no.	Signal name
Not connected	1	2	GND	Not connected	1	2	GND
Not connected	3	4	RSVD	Not connected	3	4	Not connected
Not connected	5	6	Not connected	Not connected	5	6	Not connected
GND	7	8	GND	VCC	7	8	VCC
GND	9	10	GND	VCC	9	10	VCC
DTR	11	12	DCD	Not connected	11	12	Not connected
CTS	13	14	RTS	SIM_IO	13	14	VSIM
RXD	15	16	TXD	SIM_RST	15	16	SIM_CLK
DSR	17	18	RI	Not connected	17	18	Not connected
Not connected	19	20	Not connected	SCL	19	20	Not connected
Not connected	21	22	ADC	I2S_CLK	21	22	SDA
GPIO6	23	24	GPIO5	I2S_TXD	23	24	I2S_RXD
Not connected	25	26	GPIO4	RESET_N	25	26	I2S_WA
Not connected	27	28	Not connected	Not connected	27	28	Not connected
Not connected	29	30	PWR_ON	Not connected	29	30	Not connected
GPIO3	31	32	GPIO2	Not connected	31	32	Not connected
Not connected	33	34	GPIO1	Not connected	33	34	Not connected
V_INT	35	36	Not connected	Not connected	35	36	Not connected
Not connected	37	38	Not connected	Not connected	37	38	Not connected
Not connected	39	40	Not connected	Not connected	39	40	Not connected
GND	41	42	Not connected	GND	41	42	Not connected

**Table 5: Pin-out of the 42-pin dual-in-line board-to-board connectors (J103, J104) on the ADP-R5 adapter board of the evaluation kit**

 The pins / interfaces that are not supported by a specific SARA-R5 module product version should be not driven by an external device. (See the SARA-R5 series data sheets [2], [3] and the SARA-R5 series system integration manual [4] to learn about the features supported by each SARA-R5 module product version.)

## 1.7 Board setup

1. Insert a SIM card into the **SIM card holder** (J300 on the EVB-WL3). This step is not required for EVK-SARA-R500E.
2. Connect the cellular antenna provided with the evaluation kit box to the **Cellular antenna SMA** connector on the ADP-R5 (ANT connector for transmission and reception of LTE RF signals).
3. If the GNSS functionality is required:
  - 3.1. For the EVK-R500S, EVK-R510S, EVK-SARA-R500E, connect the GNSS antenna provided with the evaluation kit box to the **GNSS antenna SMA** connector on the ADP-GNSS (J208); keep cellular GNSS detach switch (SW304) in “GNSS” position.
  - 3.2. For the EVK-R510M8S, connect the GNSS antenna provided with the evaluation kit box to the **GNSS antenna SMA** connector on the ADP-R510M8S (J112); keep cellular GNSS detach switch (SW304) in “detach” position.

Place the GNSS antenna in a location with a good view of the sky.

4. Connect the AC / DC +12 V power adapter provided with the evaluation kit box to the **9 – 18 V power input** connector (J400 on the EVB-WL3). The LED DL401 lights blue.
5. Be sure to provide a jumper socket on both the **Cellular VCC supply jumpers** (J404 on the EVB-WL3, and J109 on the ADP-R5). These jumpers provide the connection from the 3.8 V output of the supply circuit on the EVB-WL3 to the VCC input of the module.
6. To enable the board power supply, turn the **Main power switch** (SW400 on the EVB-WL3) to the ON position. The LED DL400 lights green.
  - 6.1. For the EVK-R510S and EVK-R510AWS, press the **Cellular power-on** button (SW302 on the EVB-WL3) to switch on the cellular module.
  - 6.2. For the EVK-R500S, EVK-R510M8S and EVK-SARA-R500E, the cellular module switches on.
7. For communication via the cellular module’s UART interface, the following connections are allowed and can be alternatively enabled in a mutually exclusive way (see [Table 6](#) for the switch position and LED status):
  - 7.1. Connect a USB cable to the mini-USB connector on EVB-WL3 (**Cellular USB**, J501). The LED DL501 lights blue. When a USB cable is connected to this mini-USB connector, two COM ports are enabled in Windows: the main UART interface of the cellular module is available over the first COM port opened by the driver.
  - 7.2. Connect an RS232 cable to the DB9 connector on EVB-WL3 (**Cellular RS232**, J500).
  - 7.3. Connect a USB cable to the mini-USB connector on ADP-R5 (**Cellular USB**, J201). The LED DS201 lights blue. When a USB cable is connected to this mini-USB connector, two COM ports are enabled in Windows: the two UART interfaces<sup>2</sup> of the cellular module are respectively available over the two numbered COM ports opened by the driver (to enable two UART interfaces, see the AT commands manual [\[1\]](#), the +USIO AT command).

---

<sup>2</sup> Not supported on EVK-R510AWS

Type of connections	SW401	SW403	J248	LED
Access to the main UART interface over the <b>Cellular USB</b> mini-USB connector on EVB-WL3 (J501)	ON BOARD	MINIUSB	Jumper socket on pins 1-2	DL403 DL501
Access to the main UART interface over the <b>Cellular RS232</b> DB9 connector on EVB-WL3 (J500)	ON BOARD	DB9	Jumper socket on pins 1-2	DL405
Access to the two UART interfaces <sup>3</sup> over the <b>Cellular USB</b> mini-USB connector on ADP-R5 (J201)	B2B	Do not care	Jumper socket on pins 2-3	DL404 DS201
Access to UART(s) interface(s) over the <b>DIL B2B header</b> on the top of the adapter board (J104)	B2B	Do not care	No jumper socket	DL404

**Table 6: Serial interface configuration**

 See the SARA-R5 series data sheet [2] and the +USIO AT command description in the SARA-R5 series AT commands manual [1] for the description and configuration of the USIO variants.

Run an AT terminal application (e.g. the u-blox m-center tool) and select an AT port with these settings:

- Data rate: 115,200 bit/s
- Data bits: 8
- Parity: N
- Stop bits: 1
- Flow control: HW for EVK-R500S, EVK-R510S, EVK-R510M8S and EVK-SARA-R500E  
none for EVK-R510AWS

See Appendix A for how to configure the u-blox m-center AT terminal for Windows.

8. To switch off the EVK-R500S, EVK-R510S, EVK-R510M8S and EVK-SARA-R500E, send the +CPWROFF AT command. To switch off the EVK-R510AWS, send the AT+SLEEP9 command. Make sure to use this command before switching off the main power, otherwise settings and configuration parameters may not be saved in the internal non-volatile memory of the cellular module.

<sup>3</sup> Not supported on EVK-R510AWS





## B Setting up cellular packet data connection on Windows

This section does not apply to EVK-R510AWS.

This section describes how to set up a packet data connection on Windows 10 using the operating system's TCP/IP stack and EVK-R5. This is also referred to as a dial-up connection.

### B.1 Install a new modem from the control panel

1. Open the Control Panel and select "Phone and Modem", go to the Modems tab and select "Add".

This opens the Add Hardware Wizard.

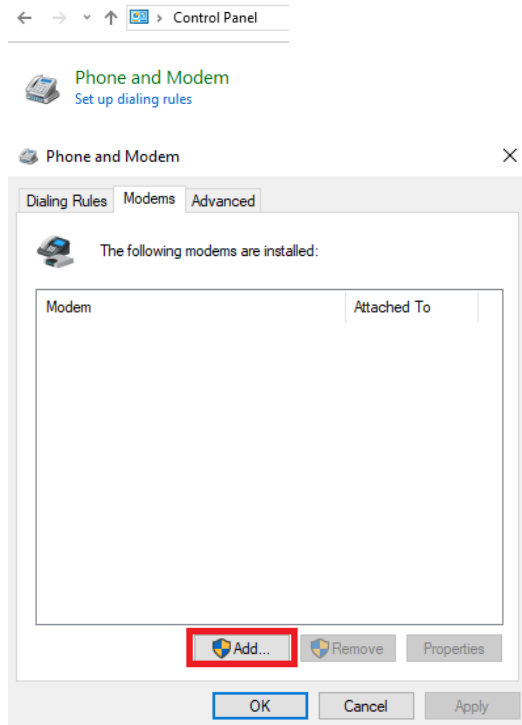

2. Tick the "Don't detect my modem" checkbox. Then select "Next".

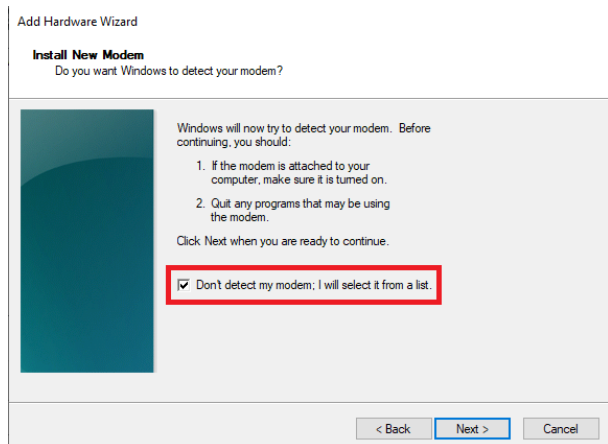

3. Select “Standard 33600 bps Modem” and click “Next”.

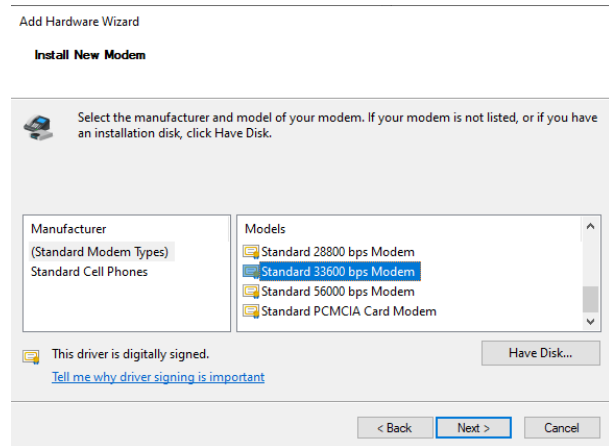

4. Select the COM port to use for data communication and click “Next”. This is the COM port on which the modem will be installed.
5. In the next step, click “Finish” to complete the modem installation.

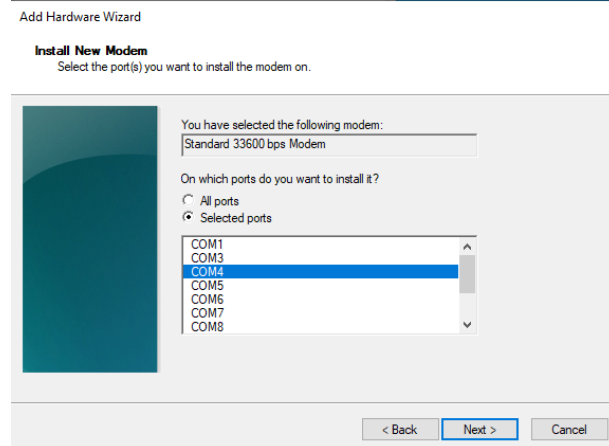

6. Now the new modem is visible under the Modems tab in Control Panel > Phone and Modem.

Any extra initialization AT command (e.g., to set a specific APN name) can be entered by selecting Properties and filling in the “Extra initialization commands” text box under the Advanced tab.

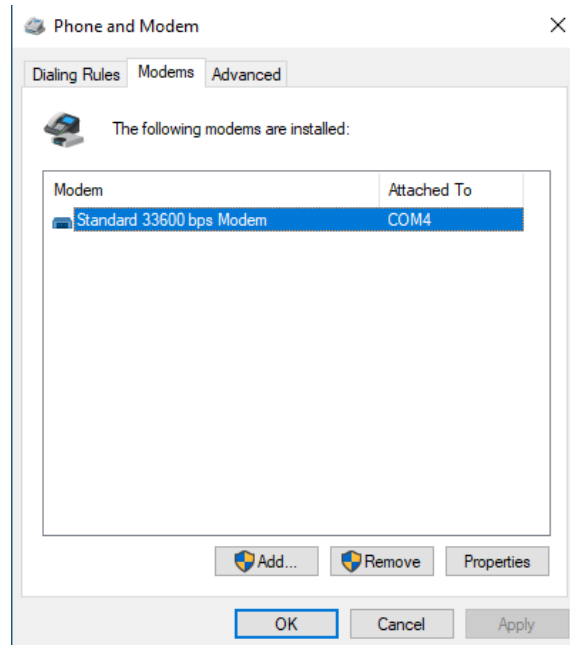

Now the module is ready and the connection can be configured.

The modem configuration can also be edited by clicking on the modem name in the Device Manager.

## B.2 Configuring a new connection

1. Open the Control Panel, go to the Network and Sharing Center, and select “Set up a new connection or network”.

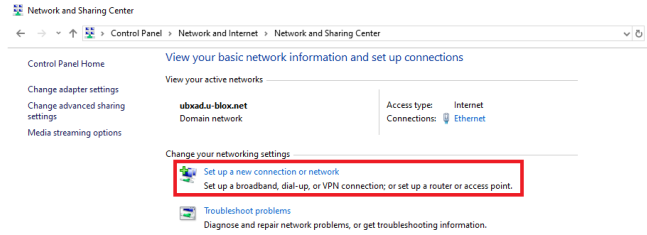

2. Select “Connect to the Internet” and click “Next”.

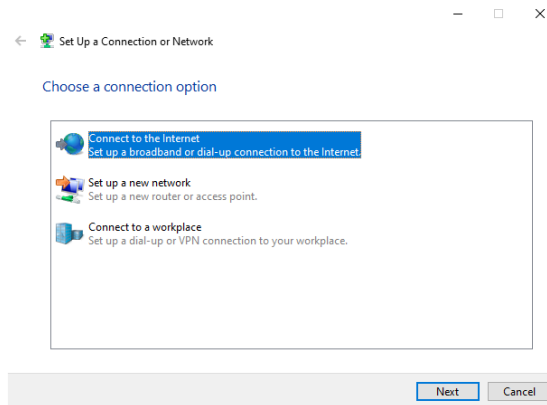

3. Select “Dial-up” and, if requested, the modem previously installed.

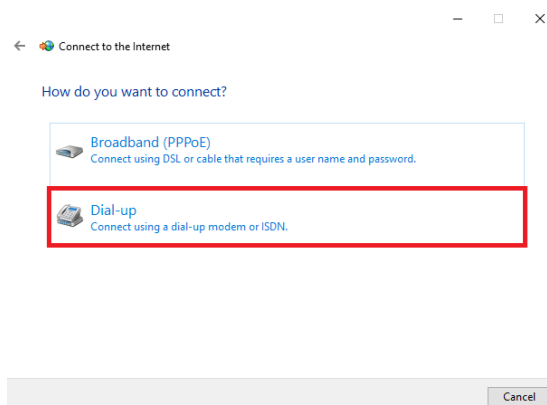

4. Enter the parameters for the dial-up connection:
  - The module telephone number:  
\*99\*\*\*1#  
(change if using a PDP context different from 1)
  - The specific account information for the network operator
  - A name for the connection (e.g., “R5 Dial-up”)

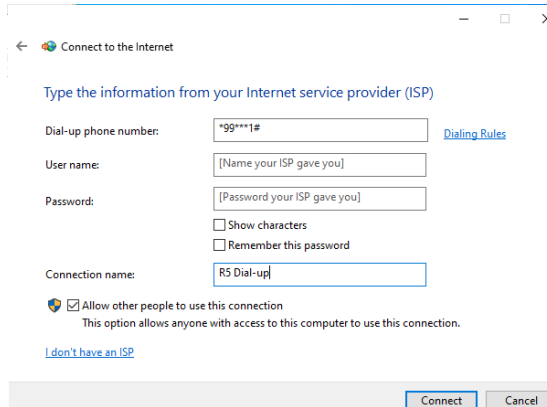

The packet data connection is now ready to be used with EVK-R5. Click “Connect” to start the connection, then start a browser to check internet connectivity.

Consult the cellular network operator for username and password. In most cases, they can be left empty.

## C AT commands examples

 This section does not apply to EVK-R510AWS. For further details on SARA-R510AWS modules AT commands, see the SARA-R510AWS application development guide [6] and the AWS IoT ExpressLink programmer's guide [7].

For the complete description and syntax of the AT commands supported by SARA-R5 series modules, see the SARA-R5 series AT commands manual [1].

For detailed AT commands examples for network registration and configuration, context activation, data connection management, SIM management, module interfaces configurations and other settings, see the u-blox SARA-R5 application development guide [5].

### C.1 Define the initial default bearer for connectivity

To change the PDN settings for the initial default EPS bearer established during LTE attach, edit the <cid>=1 PDN by means of the +CGDCONT AT command.

Command sent by DTE (user)	DCE response (module)	Description
AT+COPS?	+COPS: 2 OK	The module is not registered.
AT+CEREG=2;+CGEREP=1,1	OK	Enable a set of registration URCs.
AT+CGDCONT?	+CGDCONT: 1,"IPV4V6","", "0.0.0.0 0.0.0.0.0.0.0.0.0.0.0.0.0.0.0.0", 0,0,0,2,0,0,0,0,0 OK	Read IP type and APN for EPS attach bearer.
AT+CGDCONT=1,"IPV4V6","broadband"	OK	Set the APN name ("broadband" for example) and the PDP type ("IPV4V6" for example) for EPS attach bearer.
AT+COPS=0	OK  +CEREG: 1,"0001","01a2d001",7 +CGEV: ME PDN ACT 1	Trigger a network registration and wait for attach complete.

### C.2 Data connection using internal TCP/IP stack

Activate an internal context to use the internal TCP/UDP stack.

If an external "IP" context is active, just map the external context to an internal one.

Command sent by DTE (user)	DCE response (module)	Description
AT+CGDCONT?	+CGDCONT: 1,"IP","default.mnc321.m mcc654.gprs", "192.168.20.6",0,0,0 ,2,0,0,0,0,0 OK	Read IP type and APN for EPS attach bearer.  Context <cid>=1 has IP type "IP" and APN "default.mnc321.mcc654.gprs".
AT+CGCONTRDP=1	+CGCONTRDP: 1,5,"default.mnc321.m cc654.gprs", "192.168.20.6.255.255 .255.0", "192.168.20.1", "185.215.1 95.114", "", "", "", 0,0,1500,0,0 OK	Read context <cid>=1 dynamic parameters. <cid>=1 is currently active with IPv4 address 192.168.20.6/24, gateway 192.168.20.1 and DNS server 185.215.195.114.
AT+UPSD=0,100,1	OK	Map external context <cid>=1 to internal context <profile_id>=0.
AT+UPSDA=0,3	OK +UUPSDA: 0,"192.168.20.6"	Activate internal context <profile_id>=0. A URC is received indicating activation complete and IPv4 address for the internal context.

When an external context is mapped to an internal PSD profile, make sure that the same protocol type (IP/IPV6/IPV4V6) is set both for the context and the profile, before the PSD profile is activated.

On SARA-R5 products the default protocol type for external contexts is IPV4V6, while for internal PSD profiles is IP(v4).

Command sent by DTE (user)	DCE response (module)	Description
<b>Map a context with protocol type "IP"</b>		
AT+CGDCONT=1,"IP","default"	OK	Set context <cid>=1 with "IP" protocol type and APN string "default".
<wait for context <cid>=1 activation>		
AT+UPSD=0,100,1	OK	Map external context <cid>=1 to internal context <profile_id>=0.
AT+UPSD=0,0,0	OK	Set protocol type for internal context <profile_id>=0 to IPv4.
AT+UPSDA=0,3	OK	Activate internal context <profile_id>=0.
<b>Map a context with protocol type "IPV6"</b>		
AT+CGDCONT=1,"IPV6","default"	OK	Set context <cid>=1 with "IPV6" protocol type and APN string "default".
<wait for context <cid>=1 activation>		
AT+UPSD=0,100,1	OK	Map external context <cid>=1 to internal context <profile_id>=0.
AT+UPSD=0,0,1	OK	Set protocol type for internal context <profile_id>=0 to IPv6.
AT+UPSDA=0,3	OK	Activate internal context <profile_id>=0.
<b>Map a context with protocol type "IPV4V6"</b>		
AT+CGDCONT=1,"IPV4V6","default"	OK	Set context <cid>=1 with "IPV4V6" protocol type and APN string "default".
<wait for context <cid>=1 activation>		
AT+UPSD=0,100,1	OK	Map external context <cid>=1 to internal context <profile_id>=0.
AT+UPSD=0,0,2	OK	Set protocol type for internal context <profile_id>=0 to IPv4v6 with IPv4 preferred. Alternatively, AT+UPSD=0,0,3 can be used.
AT+UPSDA=0,3	OK	Activate internal context <profile_id>=0.

### C.3 Opening a TCP socket

Command sent by DTE (user)	DCE response (module)	Description
AT+CMEE=2	OK	Enables the cellular module to report verbose error result codes.
AT+CGATT?	+CGATT: 1 OK	Verifies the SARA-R5 module is attached to the network.
AT+CEREG?	+CEREG: 0,1 OK	Verify the network registration status.

Command sent by DTE (user)	DCE response (module)	Description
AT+COPS=0	OK	Register the module on the network. The cellular module automatically registers itself on the cellular network. This command is necessary only if the automatic registration failed (AT+CREG? returns 0,0).  The AT+COPS=0 command is strictly necessary only if the module starts up with auto-cops disabled, that is, +COPS: 2 setting stored in the profiles per design (AT&V).
AT+COPS?	+COPS: 0,0,"Verizon Wireless",7 OK	Read the operator name and radio access technology (RAT).
AT+UPSND=0,8	+UPSND: 0,8,1 OK	Check internal context <profile_id>=0 status. The PSD profile is active.
AT+USOCR=6	+USOCR: 0 OK	Create a TCP socket.
AT+USOCO=0,"185.215.195.137",7	OK	Connect to the server.
	+UUSORD: 0,32	Greeting message.
AT+USORD=0,32	+USORD: 0,32,"u-blox AG TCP/UDP test service" OK	Retrieving the message.
AT+USOCL=0	OK	Closing the socket.

## C.4 Opening a UDP socket

Command sent by DTE (user)	DCE response (module)	Description
AT+CMEE=2	OK	Enables the cellular module to report verbose error result codes.
AT+CGATT?	+CGATT: 1 OK	Verifies the SARA-R5 module is attached to the network.
AT+CEREG?	+CEREG: 0,1 OK	Verify the network registration status.
AT+COPS=0	OK	Register the module on the network. The cellular module automatically registers itself on the cellular network. This command is necessary only if the automatic registration failed (AT+CREG? returns 0,0).  The AT+COPS=0 command is strictly necessary only if the module starts up with auto-cops disabled, that is, +COPS: 2 setting stored in the profiles per design (AT&V).
AT+COPS?	+COPS: 0,0,"Verizon Wireless",7 OK	Read the operator name and radio access technology (RAT).
AT+UPSND=0,8	+UPSND: 0,8,1 OK	Check internal context <profile_id>=0 status. The PSD profile is active.
AT+USOCR=17	+USOCR: 0 OK	Create a UDP socket.
AT+USOST=0,"185.215.195.137",7,13,"TestNumberOne"	+USOST: 0,13 OK	Connecting and storing text on the server.
	+UUSORF: 0,13	Echo server returning the message.



Command sent by DTE (user)	DCE response (module)	Description
AT+USORF=0,13	+USORF: 0,"185.215.195.137",7,13, "TestNumberOne" OK	Reading the message from the server.
AT+USOCL=0	OK	Closing the socket.

## D Current consumption measurement

The current consumption of SARA-R5 modules can be measured on the EVK-R5 by removing the jumper socket from the **Cellular VCC supply jumper J109** on the ADP-R5 board, as shown in [Figure 6](#).

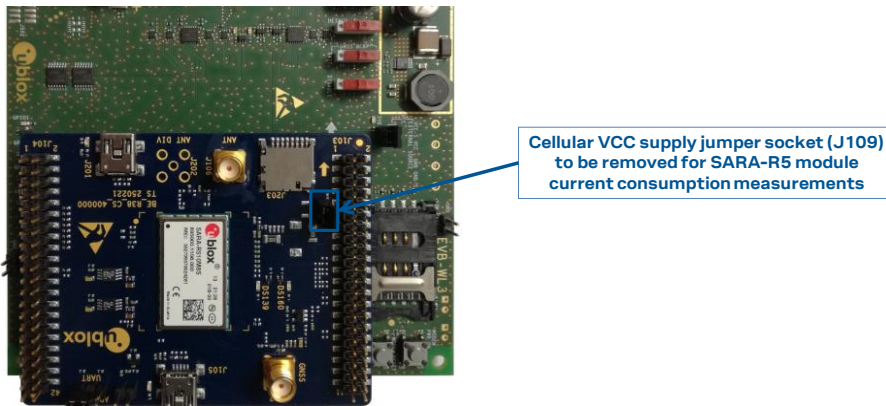

**Figure 6: Jumper socket to be removed for SARA-R5 series modules current consumption measurement**

A suitable external digital multi-meter (as for example the Keysight/Agilent 34465A, 34410A or 34411A) can be used for current consumption measurements. In this case, the 3.8 V supply circuit on the EVB will supply the cellular module mounted on the adapter board, with the digital multi-meter placed in series as illustrated in [Figure 7](#).

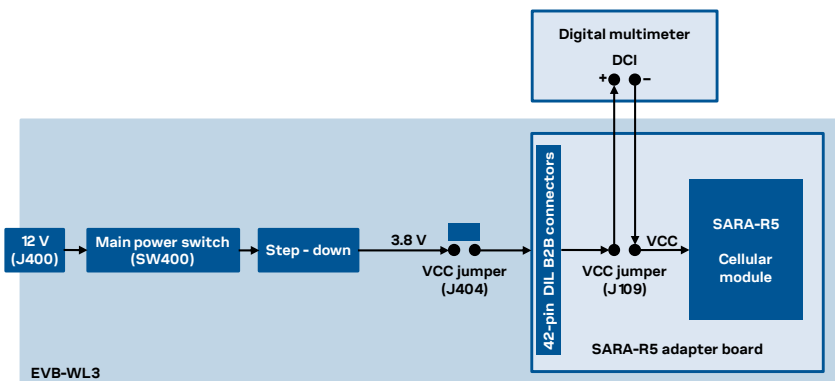

**Figure 7: Block diagram of current consumption setup for SARA-R5 series modules**

Alternatively, a suitable external DC power supply with dynamic current measurement capabilities (as for example, the portable and cheap Qoitech Otii Arc, or the more accurate Keysight N6705B, or the models designed for mobile communications Keysight 66319B/D or 66321B/D) can be used for current consumption measurements, acting also as supply source for the cellular module mounted on the adapter board, as illustrated in [Figure 8](#).

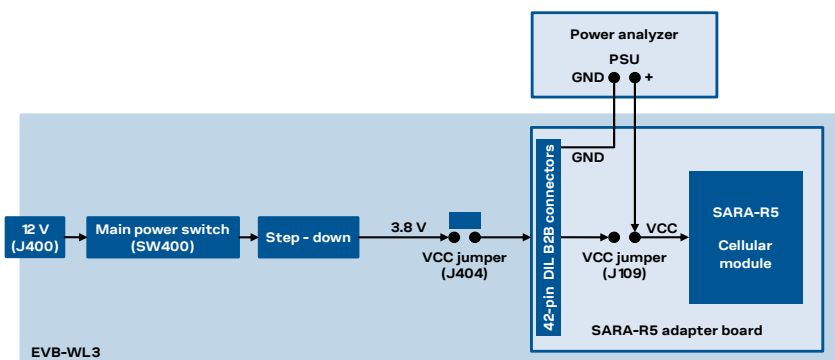

**Figure 8: Block diagram of current consumption setup for SARA-R5 series modules using a DC power analyzer**

## E Declaration of conformities

The equipment is intended for indoor usage. It is the user's duty to verify if further restrictions apply, such as in airplanes, hospitals, or hazardous locations (petrol stations, refineries...). Any changes or modification made to this equipment will void its compliance to the safety requirements.

Maintenance, inspections and/or repairs of the EVK-R5 shall be performed by u-blox AG.

## F Glossary

Abbreviation	Definition
ADP	Adapter Board
AT	AT Command Interpreter Software Subsystem, or attention
AWS	Amazon Web Services
B2B	Board-To-Board
CTS	Clear To Send
DCD	Data Carrier Detect
DCE	Data Communication Equipment
DCI	Direct Current
DIL	Dual In Line
DSR	Data Set Ready
DTE	Data Terminal Equipment
DTR	Data Terminal Ready
EVB	Evaluation Board
EVK	Evaluation Kit
GND	Ground
GNSS	Global Navigation Satellite System
GPIO	General Purpose Input Output
HW	Hardware
I2C	Inter-Integrated Circuit
I2S	Inter IC Sound
IoT	Internet of Things
IP	Internet Protocol
LED	Light Emitting Diode
LTE	Long Term Evolution
NB	Narrow Band
PSD	Packet-Switched Data
PSU	Power Supply Unit
RAT	Radio Access Technology
RF	Radio Frequency
RI	Ring Indicator
RTS	Request To Send
Rx	Receiver
SDIO	Secure Digital Input Output
SIM	Subscriber Identity Module
SMA	SubMiniature version A
TCP	Transfer Control Protocol
Tx	Transmitter
UART	Universal Asynchronous Receiver-Transmitter serial interface
UDP	User Datagram Protocol
USB	Universal Serial Bus