



# EVK-R6 and EVK-L6

LARA-R6 and LARA-L6 series cellular evaluation kits

User guide



## Abstract

This guide explains how to set up the u-blox EVK-R6 and EVK-L6 evaluation kits to begin evaluating the LARA-R6 series cellular modules supporting LTE Cat 1 / 3G / 2G radio access technologies and the LARA-L6 series cellular modules supporting LTE Cat 4 / 3G / 2G radio access technologies.

# Document information

<b>Title</b>	<b>EVK-R6 and EVK-L6</b>	
<b>Subtitle</b>	LARA-R6 and LARA-L6 series cellular evaluation kits	
<b>Document type</b>	User guide	
<b>Document number</b>	UBX-21035387	
<b>Revision and date</b>	R04	04-Apr-2023
<b>Disclosure restriction</b>	C1-Public	

This document applies to the following products:

<b>Product name</b>	<b>Type number</b>
EVK-R6001	EVK-R6001-00B-00
EVK-R6401	EVK-R6401-00B-00
EVK-R6801	EVK-R6801-00B-00
EVK-L6004	EVK-L6004-00B-00
EVK-L6004D	EVK-L6004D-00B-00

u-blox or third parties may hold intellectual property rights in the products, names, logos and designs included in this document. Copying, reproduction, modification or disclosure to third parties of this document or any part thereof is only permitted with the express written permission of u-blox.

The information contained herein is provided "as is" and u-blox assumes no liability for its use. No warranty, either express or implied, is given, including but not limited to, with respect to the accuracy, correctness, reliability and fitness for a particular purpose of the information. This document may be revised by u-blox at any time without notice. For the most recent documents, visit [www.u-blox.com](http://www.u-blox.com).

Copyright © u-blox AG.

# Contents

<b>Document information</b> .....	<b>2</b>
<b>Contents</b> .....	<b>3</b>
<b>1 Starting up</b> .....	<b>4</b>
1.1 EVK-R6 and EVK-L6 overview .....	4
1.2 EVK-R6 and EVK-L6 block diagram and basic description .....	5
1.3 Switches, jumpers and buttons .....	6
1.4 LEDs.....	6
1.5 Connectors .....	7
1.6 EVK-R6 and EVK-L6 pin out .....	8
1.7 Software installation .....	9
1.8 Board setup .....	10
1.9 Enabling error result codes .....	12
1.10 PIN code insertion (when required).....	12
1.11 Registration on a cellular network .....	12
1.12 Switching off the EVK-R6 and EVK-L6.....	12
<b>Appendix</b> .....	<b>13</b>
<b>A Setting up AT terminal applications for communication with EVK-R6 and EVK-L6...</b>	<b>13</b>
<b>B Setting up cellular packet data connection</b> .....	<b>14</b>
B.1 Install and configure a low data rate modem connection on Windows .....	14
B.2 Install and configure a high data rate modem connection on Windows .....	16
B.3 Setting up cellular packet data connection on Linux .....	18
<b>C Examples of AT commands</b> .....	<b>22</b>
C.1 Define the initial default bearer for connectivity .....	22
C.2 Data connection using internal TCP/IP stack .....	22
C.3 Opening a TCP socket .....	23
C.4 Opening a UDP socket.....	23
C.5 Configure audio interface for earphones .....	24
<b>D Current consumption measurement</b> .....	<b>25</b>
<b>E Glossary</b> .....	<b>26</b>
<b>F Declaration of conformities</b> .....	<b>26</b>
<b>Related documentation</b> .....	<b>27</b>
<b>Revision history</b> .....	<b>27</b>
<b>Contact</b> .....	<b>27</b>

# 1 Starting up

## 1.1 EVK-R6 and EVK-L6 overview

The u-blox EVK-R6 and EVK-L6 kits are powerful and easy-to-use tools that simplifies the evaluation of the LARA-R6 series multimode LTE Cat 1 / 3G / 2G cellular modules and the evaluation of the LARA-L6 series multimode LTE Cat 4 / 3G / 2G cellular modules.

The following evaluation kits are available (see [Figure 1](#)):

- EVK-R6001 evaluation kit is for evaluation of LARA-R6001 modules
- EVK-R6401 evaluation kit is for evaluation of LARA-R6401 modules
- EVK-R6801 evaluation kit is for evaluation of LARA-R6801 modules
- EVK-L6004 evaluation kit is for evaluation of LARA-L6004 modules
- EVK-L6004D evaluation kit is for evaluation of LARA-L6004D modules

All the EVK-R6001, EVK-R6401, EVK-R6801, EVK-L6004 and EVK-L6004D evaluation kits are herein identified as EVK-R6 and EVK-L6.

See the LARA-R6 series data sheet [\[2\]](#), the LARA-L6 series data sheet [\[3\]](#), and the LARA-R6 / LARA-L6 series system integration manual [\[4\]](#) for the features supported by the u-blox LARA-R6 and LARA-L6 series cellular modules.

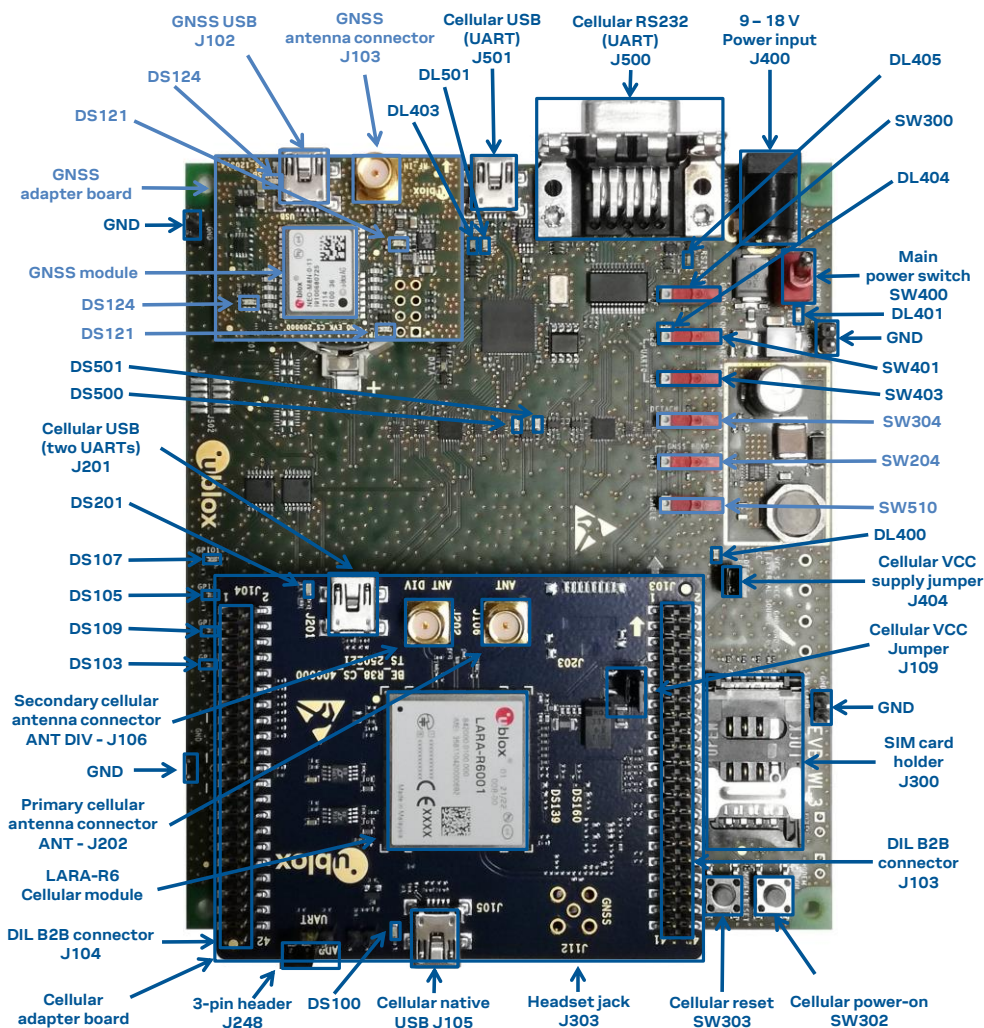

Figure 1: Overview of EVK-R6 and EVK-L6 evaluation kit for LARA-R6 and LARA-L6 modules

## 1.2 EVK-R6 and EVK-L6 block diagram and basic description

Figure 2 shows the main interfaces and internal connections of EVK-R6 and EVK-L6 evaluation kits:

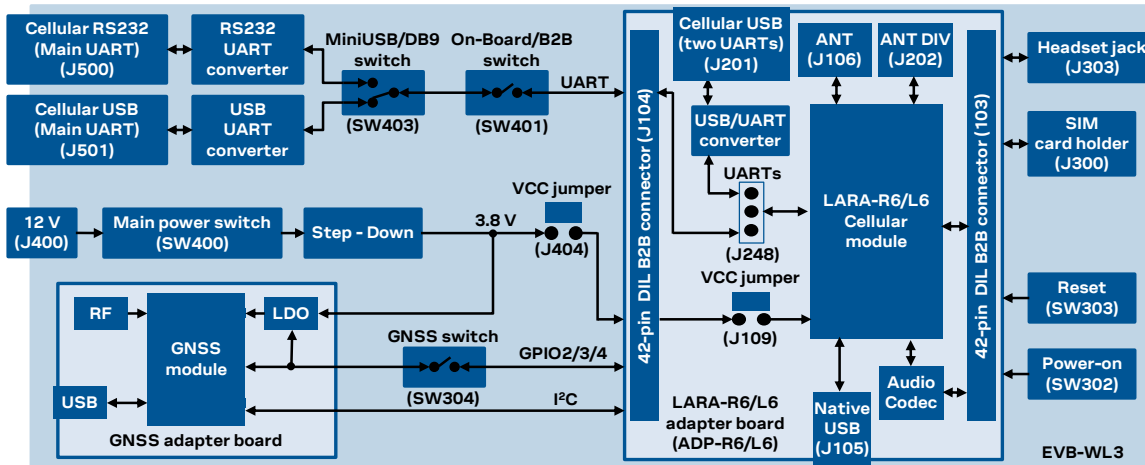

Figure 2: Block diagram of EVK-R6 and EVK-L6 for LARA-R6 and LARA-L6 modules

The EVK-R6 and EVK-L6 is formed by three boards:

- The lower one, called EVB-WL3 or simply EVB, contains the power supply and other peripherals for the cellular module (such as SIM card holder, reset button and power-on button).
- The cellular adapter board, called ADP-R6 / ADP-L6, contains the LARA-R6 / LARA-L6 cellular module, the cellular antenna connectors (ANT / ANT DIV), the USB “native” connector (J105), the USB “two UARTs” connector (J201), the UARTs routing switch (J248), the VCC jumper (J109) and an audio codec.
- The GNSS adapter board, called ADP-GNSS, contains the u-blox GNSS module, the GNSS antenna connector and the USB connector for the GNSS module.

The cellular and the GNSS adapter boards (ADP-R6/L6 and ADP-GNSS respectively) are connected by means of male header board-to-board connectors provided on the bottom of the adapter boards and their corresponding female connectors provided on top of the lower board (EVB-WL3).

The USB interface of the cellular module is available on the native USB connector (J105) on the cellular adapter board (ADP-R6 / ADP-L6).

The main UART and the auxiliary UART interfaces of the cellular module can be routed as follows, by means of the 3-way UARTs’ routing switch (J248) available on the cellular adapter board (ADP-R6 / ADP-L6) as illustrated in Figure 3:

- EVB position (pin 1-2 of J248 shorted by jumper socket): main UART routed as 8-wire interface to the lower EVB-WL3 board by the means of dual-in-line male board-to-board connectors mounted on the bottom of the adapter board ADP-R6/L6. According to the mini-USB / DB9 switch (SW403) setting on the EVB-WL3, the main 8-wire UART interface can be accessed on the USB connector (J501) or on the RS232 DB9 connector (J500) on the EVB-WL3, with the on-board / B2B switch (SW401) on the EVB-WL3 set to “on-board”. The auxiliary UART interface is not available.
- ADP position (pin 2-3 of J248 shorted by jumper socket): main UART and auxiliary UART routed as 4-wire interfaces to the USB two UARTs connector (J201) mounted on the adapter board, with the on-board / B2B switch (SW401) on the EVB-WL3 board is set to “B2B”.
- No position (no jumper socket on J248): main 8-wire UART interface or main 4-wire UART with auxiliary 4-wire UART interfaces, routed to the dual-in-line male header connectors mounted on the top of the adapter board ADP-R6/L6, allowing a connection to an external compatible device with the on-board / B2B switch (SW401) on the EVB-WL3 board set to “B2B”.

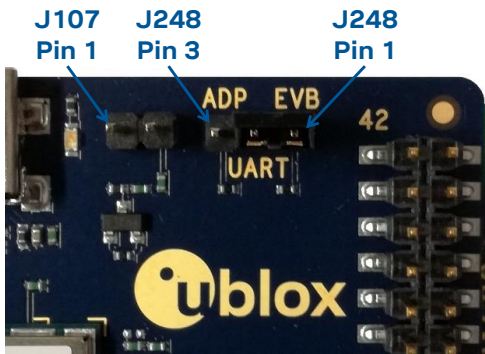

**Figure 3: 3-pin header J248 available to set the routing of the UART interfaces on the EVK for LARA-R6 / LARA-L6 modules**

The other peripherals of the cellular module are available on the dual-in-line male header connectors (J103 / J104) provided on the top layer of the cellular adapter board ADP-R6 / ADP-L6.

The lower board is designed to also be used with other u-blox cellular adapter boards. It contains additional switches, jumpers, connectors, LEDs and parts that are partially described in [Figure 1](#) or in this document, because they are intended for use only with other u-blox cellular modules. It is recommended to leave any additional connector unconnected, and to leave any additional switch in its default configuration.

## 1.3 Switches, jumpers and buttons

Function	Description	Name	Board
Main power switch	Power on / off the whole evaluation kit	SW400	EVB
Cellular VCC	Jumper socket to provide the 3.8 V supply to the cellular module VCC input	J404	EVB
Cellular power-on	Push button to switch-on the cellular module	SW302	EVB
Cellular reset	Push button to reset the cellular module	SW303	EVB
Cellular UART detach	Slide switch to attach / detach cellular module UART from USB / RS232 connectors: when detached, UART signals available only on DIL B2B connector on ADP board	SW401	EVB
Cellular UART routing	Slide switch to select cellular module main UART routing on USB or on RS232 connector	SW403	EVB
Cellular GPIO detach	Slide switch to attach / detach the cellular module GPIOs from peripherals: when detached, the signals are available only on the DIL B2B connector on ADP-R6/L6	SW300	EVB
Cellular GNSS detach	Slide switch to attach / detach the cellular module to the GNSS module (GPIO2-3-4): when detached, signals are available only on DIL B2B connector on ADP-R6/L6	SW304	EVB
GNSS V_BCKP	Slide switch to connect / disconnect backup battery to V_BCKP pin of the GNSS module	SW204	EVB
Cellular VCC	Jumper socket to provide the 3.8 V supply to the cellular module VCC input	J109	ADP-R6 ADP-L6
Cellular UARTs routing	Jumper to route cellular module UART interfaces to USB two UARTs connector (both Main and Auxiliary UART) or to lower board by the means of Dual-In-Line male Board-to-Board connectors (only Main UART)	J248	ADP-R6 ADP-L6

**Table 1: EVK-R6 and EVK-L6 switch and button descriptions**

## 1.4 LEDs

Function	Description	LED #	Board	Color
Main power	Power supply plugged in the <b>9 - 18 V Power Input</b>	DL401	EVB	
Cellular VCC	Cellular module supplied. <b>Main power switch</b> must be switched on	DL400	EVB	
Cellular native USB	USB cable plugged in the <b>Cellular native USB</b> connector	DS100	ADP-R6/L6	
Cellular two UARTs USB	USB cable plugged in the Cellular two UARTs USB connector	DS201	ADP-R6/L6	
Cellular USB	USB cable plugged in the Cellular USB connector for UART access	DL501	EVB	





Function	Description	LED #	Board	Color
Cellular USB / UART	Green light is activated when UART is routed to the cellular USB connector Red light blinks at UART TX or RX data on the Cellular USB connector	DL403	EVB	Red / Green
Cellular UART detach	UART signals are available only on the DIL connector on ADP-R6/L6 board	DL404	EVB	Green
Cellular RS232 / UART	Green light is activated when UART is routed to Cellular RS232 connector Red light blinks at UART TX or RX data on the Cellular RS232 connector	DL405	EVB	Red / Green
Cellular RI indicator	RI line turns ON (active low)	DS501	EVB	Red
Cellular CTS indicator	CTS line turns ON (active low)	DS500	EVB	Green
Cellular GPIO1 indicator	Green light is activated when cellular GPIO1 is high	DS107	EVB	Green
Cellular GPIO2 indicator	Green light is activated when cellular GPIO2 is high	DS105	EVB	Green
Cellular GPIO3 indicator	Green light is activated when cellular GPIO3 is high	DS109	EVB	Green
Cellular GPIO4 indicator	Green light is activated when cellular GPIO4 is high	DS103	EVB	Green
GNSS VCC supply	GNSS module supply is turned ON	DS118	ADP-GNSS	Green
GNSS USB	USB cable plugged in GNSS USB connector	DS124	ADP-GNSS	Blue
GNSS time pulse	Pulses at 1 Hz when valid GNSS fix	DS121	ADP-GNSS	Green
Cellular / GNSS I2C	Cellular / GNSS module communication over the I <sup>2</sup> C interface	DS132	ADP-GNSS	Yellow

**Table 2: EVK-R6 and EVK-L6 LED descriptions**

## 1.5 Connectors

Function	Description	Name	Board
9 - 18 V Power Input	Connector for the AC / DC power adapter of the EVK AC: 100-240 V, 0.8 A, 50-60 Hz / DC: +12 V, 2.5 A  IEC 60417-5172 Class II equipment	J400	EVB
SIM card holder	SIM card holder	J300	EVB
Primary cellular antenna	SMA connector for the cellular module primary antenna (ANT1, Tx/Rx)	J106	ADP-R6/L6
Secondary cellular antenna	SMA connector for the cellular module secondary antenna (ANT2, Rx)	J202	ADP-R6/L6
Cellular native USB	Mini USB connector for the cellular module native USB interface	J105	ADP-R6/L6
Cellular two UARTs USB	Mini USB connector for the cellular module main and auxiliary USB interfaces	J201	ADP-R6/L6
Cellular USB (UART)	Mini USB connector for the cellular module UART interface converted as USB interface	J501	EVB
Cellular RS232 (UART)	DB9 connector for the cellular module UART interface converted as RS232 interface	J500	EVB
DIL B2B headers	Dual-In-Line Board-to-Board connectors for cellular module interfaces	J103-J104	ADP-R6/L6
Cellular headset	Audio headset jack connector for the cellular module audio interface	J303	EVB
GNSS antenna	SMA connector for the GNSS module antenna (GNSS antenna)	J208	ADP-GNSS
GNSS USB	Mini USB connector for the GNSS module USB interface	J102	ADP-GNSS
GNSS backup battery	Backup battery socket for the GNSS module (under GNSS adapter board)	BT200	EVB
GND	Ground terminals for the probe reference	J402, J403 J405, J406	EVB

**Table 3: EVK-R6 and EVK-L6 connector descriptions**

-  **Caution!** In the unlikely event of a failure in the internal protection circuitry, there is a risk of an explosion when charging a fully or partially discharged battery. Replace the battery when it no longer has a sufficient charge for unit operation. Control the battery before use if the device has not been used for an extended period of time.
-  **Caution!** Risk of explosion if battery is replaced with an incorrect type. Dispose of used batteries according to the instructions!

## 1.6 EVK-R6 and EVK-L6 pin out

LARA-R6/L6 series		DIL B2B	LARA-R6/L6 series		DIL B2B	LARA-R6/L6 series		DIL B2B
Pin N°	Name	Name / Pin N°	Pin N°	Name	Name / Pin N°	Pin N°	Name	Name / Pin N°
1	GND	J104 pins 7-10	24	GPIO3	J104 pin 31	47	RSVD	Not present
2	RSVD	Not present	25	GPIO4	J104 pin 26	48	RSVD	Not present
3	GND	J104 pins 7-10	26	SDA	J103 pin 22	49	RSVD	Not present
4	V_INT	J104 pin 35	27	SCL	J103 pin 19	50	GND	J104 pins 7-10
5	GND	J104 pins 7-10	28	USB_D-	Not present	51	VCC	J103 pins 8-10
6	DSR	J104 pin 17	29	USB_D+	Not present	52	VCC	J103 pins 8-10
7	RI	J104 pin 18	30	GND	J104 pins 7-10	53	VCC	J103 pins 8-10
8	DCD	J104 pin 12	31	RSVD	Not present	54	GND	J104 pins 7-10
9	DTR	J104 pin 11	32	GND	J104 pins 7-10	55	GND	J104 pins 7-10
10	RTS	J104 pin 14	33	RSVD	Not present	56	ANT1	Not present
11	CTS	J104 pin 13	34	I2S_WA	Not present	57	GND	J104 pins 7-10
12	TXD	J104 pin 16	35	I2S_TXD	Not present	58	GND	J104 pins 7-10
13	RXD	J104 pin 15	36	I2S_CLK	Not present	59	ANT_DET	Not present
14	GND	J104 pins 7-10	37	I2S_RXD	Not present	60	GND	J104 pins 7-10
15	PWR_ON	J104 pin 30	38	SIM_CLK	J103 pin 16	61	GND	J104 pins 7-10
16	GPIO1	J104 pin 34	39	SIM_IO	J103 pin 13	62	ANT2	Not present
17	VUSB_DET	Not present	40	SIM_RST	J103 pin 15	63	GND	J104 pins 7-10
18	RESET_N	J103 pin 25	41	VSIM	J103 pin 14	64	GND	J104 pins 7-10
19	GPIO6	J104 pin 23	42	GPIO5	J104 pin 24	65-96	GND	J104 pins 7-10
20	GND	J104 pins 7-10	43	GND	J104 pins 7-10	97	RFCTRL1 <sup>1</sup>	J103 pin 5
21	GND	J104 pins 7-10	44	RSVD	Not present	98	RFCTRL2 <sup>1</sup>	J103 pin 6
22	GND	J104 pins 7-10	45	RSVD	Not present	99	RSVD	Not present
23	GPIO2	J104 pin 32	46	RSVD	Not present	100	RSVD	Not present

**Table 4: Interfaces of LARA-R6/L6 modules, as routed on the 42-pin dual-in-line board-to-board connectors (J103, J104) available on the adapter board ADP-R6/L6 of the EVK-R6 and EVK-L6 evaluation kits**

<sup>1</sup> LARA-R6401 and LARA-R6401D only. Pin reserved for future use (RSVD) otherwise.



Dual-in-line board-to-board connector J104				Dual-in-line board-to-board connector J103			
Signal name	Pin N°	Pin N°	Signal name	Signal name	Pin N°	Pin N°	Signal name
Not connected	1	2	GND	Not connected	1	2	GND
Not connected	3	4	Not connected	Not connected	3	4	Not connected
Not connected	5	6	Not connected	RFCTRL1 <sup>2</sup>	5	6	RFCTRL2 <sup>2</sup>
GND	7	8	GND	Not connected	7	8	VCC
GND	9	10	GND	VCC	9	10	VCC
DTR	11	12	DCD	Not connected	11	12	Not connected
CTS	13	14	RTS	SIM_IO	13	14	VSIM
RXD	15	16	TXD	SIM_RST	15	16	SIM_CLK
DSR	17	18	RI	Not connected	17	18	Not connected
Not connected	19	20	Not connected	SCL	19	20	Not connected
Not connected	21	22	Not connected	Not connected	21	22	SDA
GPIO6	23	24	GPIO5	Not connected	23	24	Not connected
Not connected	25	26	GPIO4	RESET_N	25	26	Not connected
Not connected	27	28	Not connected	Not connected	27	28	Not connected
Not connected	29	30	PWR_ON	Not connected	29	30	Not connected
GPIO3	31	32	GPIO2	Not connected	31	32	Not connected
Not connected	33	34	GPIO1	Not connected	33	34	Not connected
V_INT	35	36	Not connected	Not connected	35	36	Not connected
Not connected	37	38	Not connected	Not connected	37	38	Not connected
Not connected	39	40	Not connected	Not connected	39	40	Not connected
GND	41	42	Not connected	GND	41	42	Not connected

**Table 5: Pin-out of the 42-pin dual-in-line board-to-board connectors (J103, J104) available on the adapter board ADP-R6/L6 of the EVK-R6 and EVK-L6 evaluation kits for LARA-R6/L6 series modules**

 The pins / interfaces that are not supported by a specific LARA-R6 / LARA-L6 product version should not be driven by an external device (see the LARA-R6 series data sheet [2], the LARA-L6 series data sheet [3] and the LARA-R6 / LARA-L6 series system integration manual [4] for the features supported by each LARA-R6 / LARA-L6 product version).

## 1.7 Software installation

The LARA-R6 and LARA-L6 USB drivers for Windows OS are available with the EVK-R6 and EVK-L6. Download the executable file from <https://www.u-blox.com/en/product/evk-r6> and save it to any location on the computer. Start the installation by running the executable.

<sup>2</sup> LARA-R6401 and LARA-R6401D only. Pin reserved for future use (RSVD) otherwise.

## 1.8 Board setup

1. Insert a SIM card into the **SIM card holder** (J300 on the EVB).
2. Connect a cellular antenna provided with the EVK-R6 and EVK-L6 evaluation kit box to the **Primary cellular antenna** SMA connector on the ADP-R6 / ADP-L6 (ANT, RF input/output for transmission and reception of LTE/3G/2G RF signals)
3. Connect a cellular antenna provided with the EVK-R6 and EVK-L6 evaluation kit box to the **Secondary cellular antenna** SMA connector on the ADP-R6 / ADP-L6 (ANT DIV, RF input for the reception of the LTE / 3G RF signals as per Down-Link Rx diversity and/or MIMO 2x2). Place the secondary cellular antenna far enough from the primary cellular antenna (more than 20 cm).
4. If the GNSS functionality is required, connect the GNSS antenna provided with the evaluation kit to the **GNSS antenna** SMA connector on the ADP-GNSS. Keep the cellular GNSS detach switch (SW304) in “GNSS” position. Place the GNSS antenna in a location with a good view of the sky.
5. Connect the AC / DC +12 V power adapter provided with the evaluation kit box to the **9 – 18 V Power Input** connector (J400 on the EVB). LED DL401 lights blue.
6. Be sure to provide a jumper socket on the **Cellular VCC supply jumper** (J404 on the EVB) and to **Cellular VCC supply jumper** (J109 on the ADP-R6 / ADP-L6). These provide the connection from the 3.8 V output of the supply circuit from the EVB to the VCC input of the cellular module.
7. To enable the board power supply, turn the **Main power switch** (SW400 on the EVB) to the ON position. LED DL400 lights green. The cellular module is powered but still switched off.
8. For communication via the cellular module’s USB interface, connect a USB cable to the **Cellular native USB** (J105) connector (on ADP-R6 / ADP-L6). LED DS100 on ADP-R6 / ADP-L6 lights blue.

Once the switch-on of the cellular module is triggered (see point 11), the COM ports listed in the [Table 6](#) are enabled by the Windows USB driver after the end of the module boot (details as the numbering of the ports can be seen via the Windows Device Manager)<sup>3</sup>:

Parameter	Type	Remarks
u-blox Modem USB1 AT and Data	Modems	AT command interface and data communication
u-blox Modem USB2 AT and Data	Modems	AT command interface and data communication
u-blox Modem USB3 AT and Data	Modems	AT command interface and data communication
u-blox Modem USB0 Diagnostics Log	Ports (COM & LPT)	Diagnostic purpose

**Table 6: Cellular USB interface configuration**

Run an AT terminal application (such as u-blox m-center), selecting an AT port with these settings:

- Data rate: 115,200 bit/s
- Data bits: 8
- Parity: N
- Stop bits: 1
- Flow control: HW

See appendix [A](#) for how to configure the u-blox m-center AT terminal for Windows.

<sup>3</sup> A message of “driver installation fail” may appear on Windows if the USB cable has been connected before the end of the module boot, but this can be ignored as the normal operating functionality of the module will be available anyway after the end of the module boot.

9. For communication via the cellular module's UART interfaces, the following connections are allowed and can be alternatively enabled in a mutually exclusive way (see [Table 7](#) for the switch position and LED status, and see [Figure 1](#) and [Figure 3](#) for the location of the related connectors, slide switches and the 3-way UARTs' routing switch J248):
  - a. Connect a USB cable to the mini-USB connector (**Cellular USB Main UART**, J501 on EVB). The LED DL501 lights blue. When a USB cable is connected to this mini-USB connector, two COM ports are enabled in Windows. The main 8-wire UART interface of the cellular module is available over the first COM port opened by the driver after the end of the module boot, once the switch-on of the cellular module is triggered (see point 11).
  - b. Connect an RS232 cable to the DB9 connector (**Cellular RS232 Main UART**, J500 on EVB): the main 8-wire UART interface of the cellular module is available over RS232 after the end of the module boot, once the switch-on of the cellular module is triggered (see point 11).
  - c. Connect a USB cable to the mini-USB connector (**Cellular USB two UARTs**, J201 on ADP-R6 / ADP-L6). The LED DS201 lights blue. The two 4-wire UART interfaces of the cellular module are respectively available over the two numbered COM ports opened by the driver after the end of the module boot, once the switch-on of the module is triggered (see point 11). (To enable two UART interfaces, see the AT commands manual [1], the +USIO AT command.)

Type of connections	SW401	SW403	J248	LED
Access to the main UART interface over the <b>Cellular USB</b> (Main UART) mini-USB connector on EVB-WL3 (J501)	ON BOARD	MINIUSB	Jumper socket on pins 1-2	DL403 DL501
Access to the main UART interface over the <b>Cellular RS232</b> (Main UART) DB9 connector on EVB-WL3 (J500)	ON BOARD	DB9	Jumper socket on pins 1-2	DL405
Access to the two UART interfaces over the <b>Cellular USB</b> (Two UARTs) mini-USB connector on ADP-R6/L6 (J201)	B2B	Do not care	Jumper socket on pins 2-3	DL404 DS201
Access to UART(s) interface(s) over the <b>DIL B2B header</b> on the top of the adapter board (J104)	B2B	Do not care	No jumper socket	DL404

**Table 7: UART serial interfaces configuration**

Run an AT terminal application (e.g., the u-blox m-center tool) selecting an AT port, with these settings:

- Data rate: 115,200 bit/s
- Data bits: 8
- Parity: N
- Stop bits: 1
- Flow control: HW

See appendix A for how to configure the u-blox m-center AT terminal for Windows.

10. If the audio functionality is required, connect the headset provided with the evaluation kit box to the **Headset jack** connector (J303 on EVB).
11. Press the **Cellular power-on** button (SW302 on the EVB) to switch on the cellular module mounted on the APD-R6.

## 1.9 Enabling error result codes

Command sent by DTE (user)	DCE response (module)	Description
AT+CMEE=2	OK	Enables the cellular module to report verbose error result codes.

## 1.10 PIN code insertion (when required)

Command sent by DTE (user)	DCE response (module)	Description
AT+CPIN="8180"	OK	Enter the PIN code, if needed (enter the PIN of the SIM card – 8180 is written here as an example).
AT+CLCK="SC",0,"8180"	OK	Unlock the PIN at power-on (the last parameter is the PIN of the SIM card – 8180 is written here as an example).
AT+CLCK="SC",1,"8180"	OK	Lock the PIN at power-on (the last parameter is the PIN of the SIM card – 8180 is written here as an example).

## 1.11 Registration on a cellular network

Command sent by DTE (user)	DCE response (module)	Description
AT+CREG?	+CREG: 0,1 OK	Verify the network registration.
AT+COPS=0	OK	Register the module on the network. The cellular module automatically registers itself on the cellular network. This command is necessary only if the automatic registration failed (AT+CREG? returns 0,0).
AT+COPS?	+COPS: 0,0,"I TIM",7 OK	Read the operator name and radio access technology (RAT).

See appendix C for further AT command examples describing how to define the initial default bearer for connectivity, how to set up a data connection using internal TCP/IP stack, how to open a TCP socket, or how to open a UDP socket.

## 1.12 Switching off the EVK-R6 and EVK-L6

To switch off the cellular module in the EVK-R6 and EVK-L6, send the +CPWROFF AT command. Make sure to use this command before switching off the main power, otherwise settings and configuration parameters may not be saved in the internal non-volatile memory of the cellular module.

## Appendix

# A Setting up AT terminal applications for communication with EVK-R6 and EVK-L6

The u-blox m-center tool is a powerful platform for evaluating, configuring and testing u-blox cellular products. m-center includes an AT commands terminal for communication with the device and can be downloaded free-of-charge from <https://www.u-blox.com/en/product/m-center>. For m-center example scripts, visit <https://github.com/u-blox/m-center>.

1. Follow the board setup instructions in section 1.8 to provide all the required connections and switching on the cellular module.
2. Run the m-center tool: after the m-center start-up, the **Home** page appears.

3. On the **Home** page, set up the AT COM port; for the setting values see section 1.8.

Check with the Windows Device Manager to find out which COM port is being used by the EVK-R6 and EVK-L6.

4. Enable the connection to u-blox cellular module by clicking on the **Connect** button.
5. Retrieve the module and network information by clicking on the **Get Info** button.

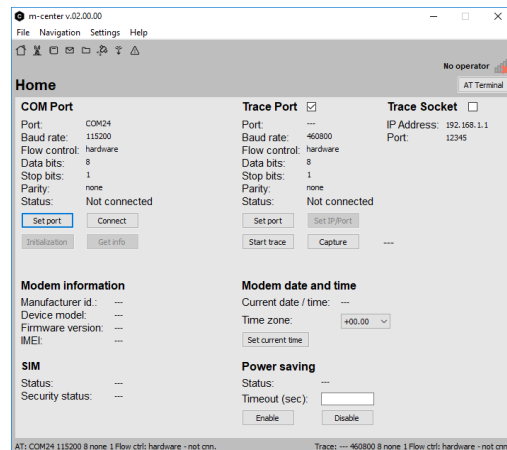

Figure 4: "Home" page

6. The module information is retrieved and displayed on the **Home** page.
7. Click on the **AT Terminal** button, found at the upper right of the **Home** page. A new window opens and the AT-command terminal is now ready for communication with the EVK-R6 and EVK-L6.

8. The AT terminal is ready to use.

For the complete list of AT commands supported by the modules and their syntax, see the u-blox AT commands manual [1].

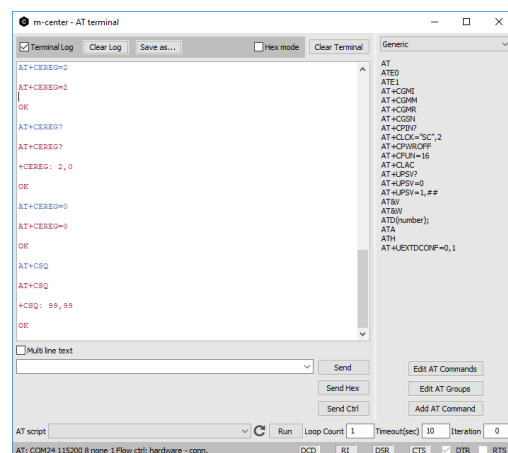

Figure 5: AT Terminal window

For more information on using the u-blox m-center cellular module evaluation tool, press the F1 key on the keyboard to open the m-center help window on the computer.

## B Setting up cellular packet data connection

To set up high data rate connection on EVK-L6, see LARA-L6 series Linux integration guide [6].

This section describes how to set up a packet data connection on Windows 10 and Linux using the operating system's TCP/IP stack and EVK-R6 and EVK-L6. This is also referred to as a dial-up connection (PPP), which is not ideal in the throughput performance perspective but it may be good enough for many applications that do not require high data rate connection.

The following examples describe how to install and configure two different kinds of modems on Windows:

1. Low data rate modem: via the UART interface of the cellular module connected to the Windows PC by the **Cellular USB** connector (J501 on EVB) or the **Cellular RS232** connector (J500 on EVB)
2. Higher data rate modem: via the native USB interface of the cellular module connected to the Windows PC by the **Cellular Native USB** connector (J105 on the ADP-R6 / ADP-L6)
3. Higher data rate modem: via the native USB interface of the cellular module connected to Linux Ubuntu 22.04 by the **Cellular Native USB** connector (J105 on the ADP-R6 / ADP-L6)

### B.1 Install and configure a low data rate modem connection on Windows

This example describes how to install and configure a low data rate packet data connection on a PC with the Windows 10 operating system. This uses the TCP/IP stack of the PC over the UART interface of the cellular module connected to the Windows PC by the Cellular USB connector (J501 on EVB) or the Cellular RS232 connector (J500 on EVB).

1. From **Control Panel**, select **Phone and Modem > Modems > Add**.

This opens the Add Hardware Wizard.

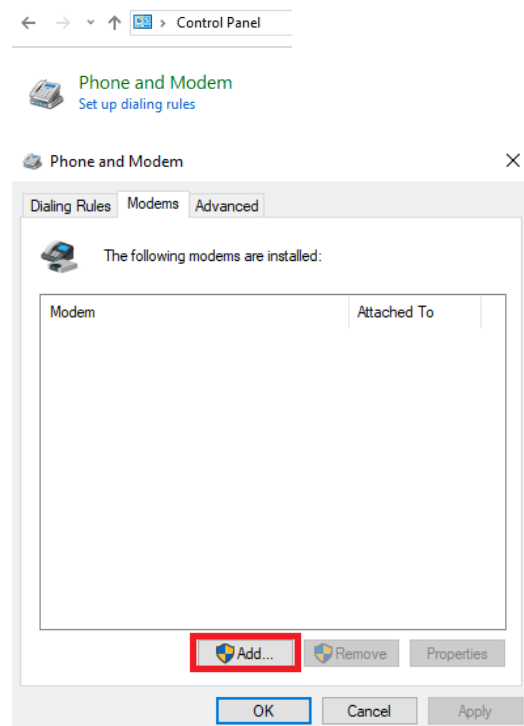

2. Tick “Don’t detect my modem” checkbox. Then click **Next**.

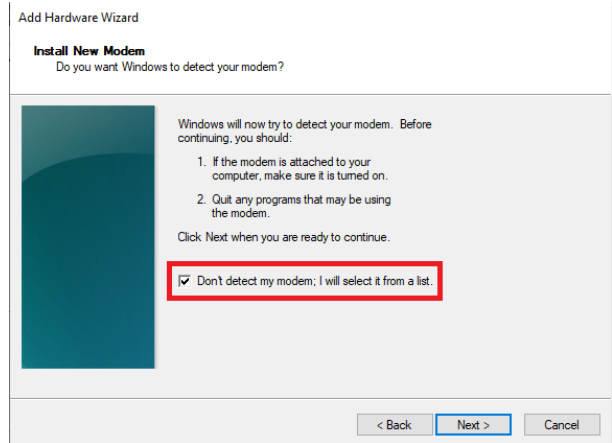

3. Select **Standard 33600 bps Modem** and click **Next**.

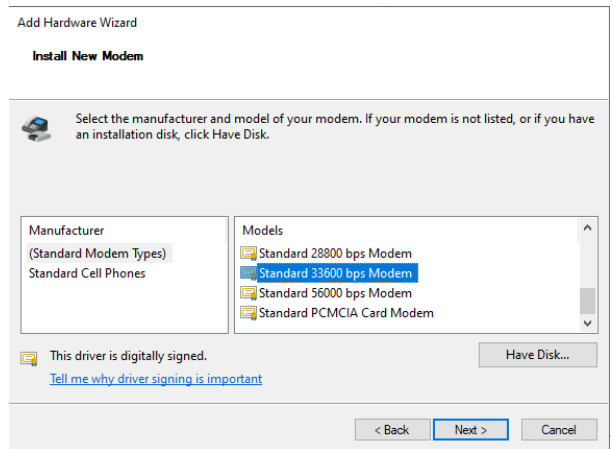

4. Select the COM port to use for data communication and click **Next**. This is the COM port on which the modem will be installed.
5. In the next step, click **Finish** to complete the modem installation.

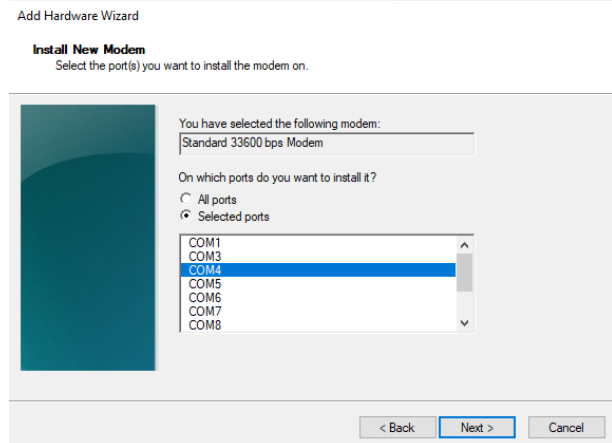



- Now the new modem is visible in **Control Panel**, under **Phone and Modem > Modems**.

Any extra initialization AT command (e.g., to set a specific APN name) can be entered by selecting **Properties** and filling in **Advanced > Extra initialization commands** text box.

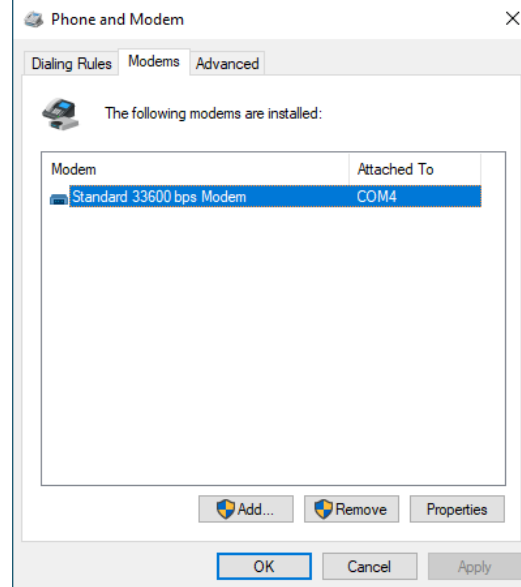

Now the module is ready, and the connection can be configured.

The modem configuration can also be edited in **Device Manager**, by clicking on the modem name.

## B.2 Install and configure a high data rate modem connection on Windows

This example describes how to install and configure a high data rate packet data connection on a PC with the Windows 10 operating system, using the TCP/IP stack of the PC, over the native USB interface of the cellular module connected to the Windows PC by the Cellular Native USB connector (J105 on the ADP-R6 / ADP-L6).

- From **Control Panel**, select **Network and Sharing Center > Set up a new connection or network**.

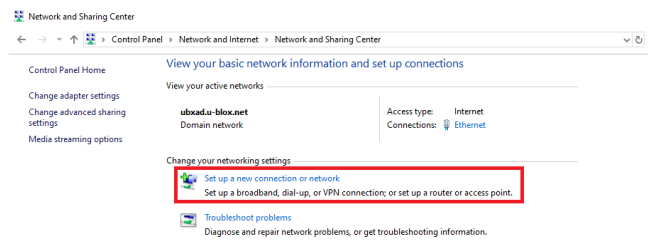

- Click **Connect to the Internet** and then **Next**.

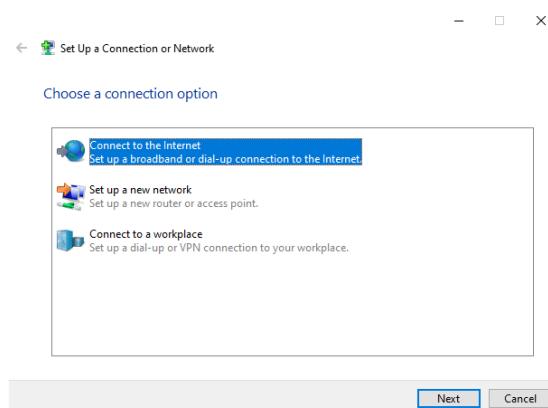

3. Select **Dial-up** and, if requested, the modem previously installed.

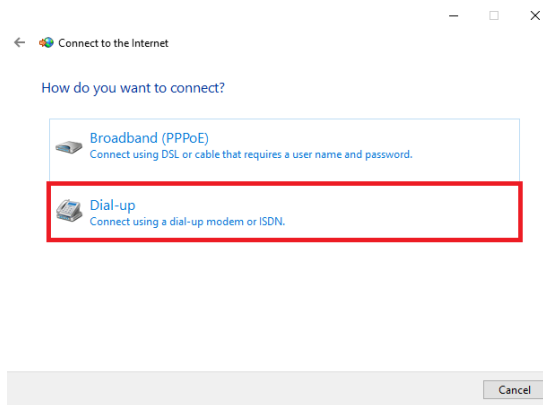

4. Select one of the two AT commands ports.

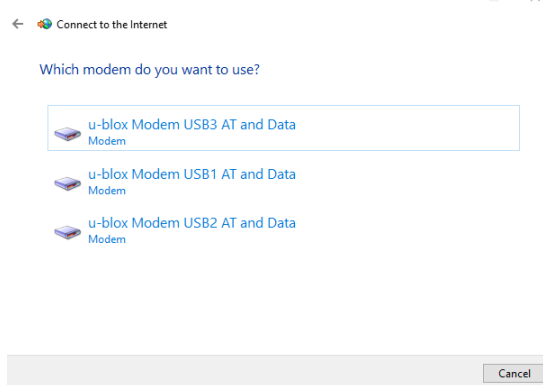

5. Enter the parameters for the dial-up connection:
  - The module telephone number: `*99***1#`  
(change if using a PDP context different from 1)
  - The specific account information for the network operator
  - A name for the connection (e.g., “R6 Dial-up”)

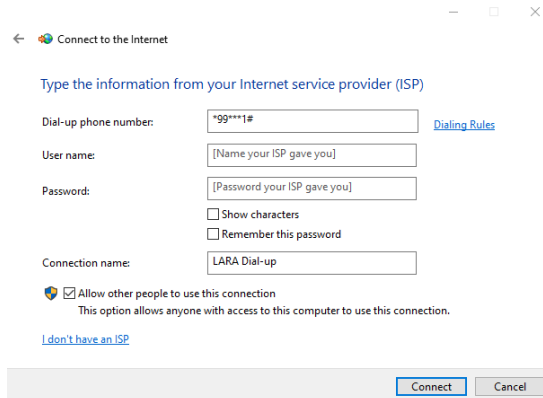

The packet data connection is now ready to be used with EVK-R6 and EVK-L6. Click “Connect” to start the connection, then start a browser to check internet connectivity.

Consult the cellular network operator for username and password. In most cases, they can be left empty.

## B.3 Setting up cellular packet data connection on Linux

This section describes how to set up a packet data connection on Linux (reference OS: Ubuntu 22.04) on a PC connected with EVK-R6 and EVK-L6 over the USB interface of the modules. Follow the board setup instructions described in section 1.8 to provide communication via the USB interface of the modules. Use minicom or similar program to send AT commands via USB.

1. LARA-R6 and LARA-L6 use a non-standard USB specific class (Vendor Specific USB class). To enumerate correctly on Linux hosts, use **option** driver:

```
/lib/modules/<kernel_version>/kernel/drivers/usb/serial/option.c.
```

To check if the module is correctly enumerated, for LARA-R6 use `lsusb -t -d 05c6:908b`; for LARA-L6 in default mode, use `lsusb -t -d 1546:1341`.

```

root@testvm: ~
root@testvm:~# lsusb -t -d 05c6:908b
/: Bus 02.Port 1: Dev 1, Class=root_hub, Driver=xhci_hcd/6p, 5000M
/: Bus 01.Port 1: Dev 1, Class=root_hub, Driver=xhci_hcd/8p, 480M
 |__ Port 1: Dev 14, If 0, Class=Human Interface Device, Driver=usbhid, 12M
 |__ Port 2: Dev 15, If 2, Class=Vendor Specific Class, Driver=option, 480M
 |__ Port 2: Dev 15, If 0, Class=Vendor Specific Class, Driver=option, 480M
 |__ Port 2: Dev 15, If 3, Class=Vendor Specific Class, Driver=option, 480M
 |__ Port 2: Dev 15, If 1, Class=Vendor Specific Class, Driver=option, 480M
root@testvm:~#
    
```

2. Identify the **ttyUSB\*** ports by `ls /dev/ttyUSB*` and then launch minicom to use this port. LARA-R6 enumerates the port as `ttyUSB0: diagnostic, ttyUSB1/ttyUSB2: AT interface, ttyUSB3: GNSS tunneling/AT interface` varying on the +USIO configuration. In the example below, **ttyUSB1** is used.

```

root@testvm:~# ls /dev/ttyUSB*
/dev/ttyUSB0 /dev/ttyUSB1 /dev/ttyUSB2 /dev/ttyUSB3
root@testvm:~#
    
```

```

Welcome to minicom 2.8

OPTIONS: I18n
Port /dev/ttyUSB1, 09:01:51

Press CTRL-A Z for help on special keys

AT
OK
    
```

3. In AT terminal, enter the following AT commands to set the **PDP\_type** and the **APN**.

Command sent by DTE (user)	DCE response (module)	Description
AT+CFUN=4	OK	Set the module in airplane mode. The module will deregister from the network and both RF Tx and RF Rx will be disabled.
AT+CGDCONT=1,"IP","ibox.tim.it"	OK	Define a PDP context with preferred APN: in this example, the "ibox.tim.it" APN is selected.
AT+CFUN=1	OK	Set the module to full functionality. The module starts the automatic network registration.
AT+CPIN?	+CPIN: READY OK	Check the SIM PIN status and act accordingly.
AT+COPS?	+COPS: 0,0,"I TIM",7 OK	Check the +COPS <AcT> parameter to see if the module is registered to the network.

- Use **pppd** in Linux as PPP daemon. The following configuration scripts can be used to start a PPP connection through the module.

```

root@testvm: ~
root@testvm:~# cat /etc/chatscripts/example.chat
# Abort conditions
ABORT 'BUSY'
ABORT 'NO CARRIER'
ABORT 'NO DIALTONE'
ABORT 'ERROR'
ABORT 'NO ANSWER'

# Default timeout
TIMEOUT 30

# Configurations
'' 'AT'
OK 'ATZ'
OK 'ATQ0 V1 E1 &S0 &C1 &D2'

# Configure the APN
#OK 'AT+CFUN=4'
#OK 'AT+CGDCONT=1,"IP","apn_name"'
#OK 'AT+CFUN=1'

# Dial out
OK 'ATD*99***1#'
CONNECT
root@testvm:~# █

root@testvm: ~
root@testvm:~# cat /etc/ppp/peers/example_exe
file /etc/ppp/example_options
connect "/usr/sbin/chat -v -t15 -f /etc/chatscripts/example.chat"
root@testvm:~# █

root@testvm: ~
root@testvm:~# cat /etc/ppp/example_options
/dev/ttyUSB2
115200
asyncmap 0
noauth
lock
lcp-echo-interval 30
lcp-echo-failure 4
noipx
usepeerdns
debug
root@testvm:~#
    
```

5. Start the PPP with `pon example_exe` command and check with `ifconfig` command if the PPP interface (in the example `ppp0`). Now it is possible to browse the Internet.

```

root@testvm: ~
root@testvm:~# pon example_exe
root@testvm:~# ifconfig
eth0: flags=4163<UP,BROADCAST,RUNNING,MULTICAST> mtu 1500
    inet 10.0.2.15 netmask 255.255.255.0 broadcast 10.0.2.255
    inet6 fe80::97e4:a88f:1cc0:971a prefixlen 64 scopeid 0x20<link>
    ether 08:00:27:29:3f:0c txqueuelen 1000 (Ethernet)
    RX packets 335 bytes 167891 (167.8 KB)
    RX errors 0 dropped 0 overruns 0 frame 0
    TX packets 456 bytes 65836 (65.8 KB)
    TX errors 0 dropped 0 overruns 0 carrier 0 collisions 0

lo: flags=73<UP,LOOPBACK,RUNNING> mtu 65536
    inet 127.0.0.1 netmask 255.0.0.0
    inet6 ::1 prefixlen 128 scopeid 0x10<host>
    loop txqueuelen 1000 (Local Loopback)
    RX packets 42 bytes 4254 (4.2 KB)
    RX errors 0 dropped 0 overruns 0 frame 0
    TX packets 42 bytes 4254 (4.2 KB)
    TX errors 0 dropped 0 overruns 0 carrier 0 collisions 0

ppp0: flags=4305<UP,POINTOPOINT,RUNNING,NOARP,MULTICAST> mtu 1500
    inet 10.44.21.188 netmask 255.255.255.255 destination 10.64.64.64
    ppp txqueuelen 3 (Point-to-Point Protocol)
    RX packets 5 bytes 62 (62.0 B)
    RX errors 0 dropped 0 overruns 0 frame 0
    TX packets 9 bytes 143 (143.0 B)
    TX errors 0 dropped 0 overruns 0 carrier 0 collisions 0

root@testvm:~# ping -I ppp0 8.8.8.8
PING 8.8.8.8 (8.8.8.8) from 10.44.21.188 ppp0: 56(84) bytes of data.
64 bytes from 8.8.8.8: icmp_seq=1 ttl=112 time=192 ms
64 bytes from 8.8.8.8: icmp_seq=2 ttl=112 time=44.6 ms
64 bytes from 8.8.8.8: icmp_seq=3 ttl=112 time=39.5 ms
64 bytes from 8.8.8.8: icmp_seq=4 ttl=112 time=37.1 ms
64 bytes from 8.8.8.8: icmp_seq=5 ttl=112 time=37.7 ms
^C
--- 8.8.8.8 ping statistics ---
5 packets transmitted, 5 received, 0% packet loss, time 4007ms
rtt min/avg/max/mdev = 37.073/70.178/191.989/60.961 ms
root@testvm:~#
    
```

6. To stop the ppp, type `poff example_exe`.

## C Examples of AT commands

For the complete description and syntax of the AT commands supported by LARA-R6 / LARA-L6 series modules, see the u-blox AT commands manual [1].

### C.1 Define the initial default bearer for connectivity

To change the PDN settings for the initial default EPS bearer established during LTE attach, edit the <cid>=1 PDN by means of the +CGDCONT AT command.

Command sent by DTE (user)	DCE response (module)	Description
AT+COPS?	+COPS: 2 OK	The module is not registered.
AT+CREG=2;+CGEREP=1,1	OK	Enable a set of registration URCS.
AT+CGDCONT?	+CGDCONT: 1,"IPV4V6","", "0.0.0.0 0.0.0.0.0.0.0.0.0.0.0.0.0.0.0", 0,0,0,2,0,0,0,0,0,0 OK	Read IP type and APN for EPS attach bearer.
AT+CGDCONT=1,"IPV4V6","broadband"	OK	Set the APN name ("broadband" for example) and the PDP type ("IPV4V6" for example) for EPS attach bearer.
AT+COPS=0	OK  +CREG: 1,"0001","01a2d001",7 +CGEV: ME PDN ACT 1	Trigger a network registration and wait for attach complete.

The same procedure can also be applied for the PDP context associated with <cid>=1 in 2G and 3G RAT. During the LTE attach, the initial default EPS bearer is automatically activated by the network, while in 2G and 3G RAT, it is necessary to manually activate the PDP context by means of +CGACT AT command.

Command sent by DTE (user)	DCE response (module)	Description
AT+CGACT=1,1	OK	Activate the PDP context associated with <cid>=1.

It is possible to verify the status of the initial default EPS bearer or a PDP context by the means of the +CGDCONT and +CGCONTRDP AT commands.

Command sent by DTE (user)	DCE response (module)	Description
AT+CGDCONT?	+CGDCONT: 1,"IP","default.mnc321.mcc654.gprs", "192.168.20.6",0,0,0 2,0,0,0,0,0,0 OK	Read IP type and APN for EPS attach bearer. Context <cid>=1 has IP type "IP" and APN "default.mnc321.mcc654.gprs".
AT+CGCONTRDP=1	+CGCONTRDP: 1,5,"default.mnc321.mcc654.gprs", "192.168.20.6.255.255.255.0", "192.168.20.1", "185.215.195.114", "", "", "", 0,0,1500,0,0 OK	Read context <cid>=1 dynamic parameters. <cid>=1 is currently active with IPv4 address 192.168.20.6/24, gateway 192.168.20.1 and DNS server 185.215.195.114.

### C.2 Data connection using internal TCP/IP stack



This section is not applicable to LARA-L6 as TCP/IP stack is not supported.

The internal TCP/IP stack is automatically mapped, configured, and activated to the initial default EPS bearer established during LTE attach or to the first activated PDP context in 2G or 3G RAT. Consequently the +UPSD and +UPSDA commands are no longer required to perform these tasks manually.



## C.3 Opening a TCP socket

 This section is not applicable to LARA-L6 as TCP/IP stack is not supported.

Command sent by DTE (user)	DCE response (module)	Description
AT+CMEE=2	OK	Enables the cellular module to report verbose error result codes.
AT+CGATT?	+CGATT: 1 OK	Verifies the module is attached to the network.
AT+CEREG?	+CEREG: 0,1 OK	Verify the network registration status.
AT+COFS=0	OK	Register the module on the network. The cellular module automatically registers itself on the cellular network. This command is necessary only if the automatic registration failed (AT+CEREG? returns 0,0).
AT+COFS?	+COFS: 0,0,"Verizon Wireless",7 OK	Read the operator name and radio access technology (RAT).
AT+USOCR=6	+USOCR: 0 OK	Create a TCP socket.
AT+USOCO=0,"echo.u-blox.com",7	OK	Connect to the server.
	+UUSORD: 0,32	Greeting message.
AT+USORD=0,32	+USORD: 0,32,"u-blox AG TCP/UDP test service" OK	Retrieving the message.
AT+USOCL=0	OK	Closing the socket.

## C.4 Opening a UDP socket

 This section is not applicable to LARA-L6 as TCP/IP stack is not supported.

Command sent by DTE (user)	DCE response (module)	Description
AT+CMEE=2	OK	Enables the cellular module to report verbose error result codes.
AT+CGATT?	+CGATT: 1 OK	Verifies the module is attached to the network.
AT+CEREG?	+CEREG: 0,1 OK	Verify the network registration status.
AT+COFS=0	OK	Register the module on the network. The cellular module automatically registers itself on the cellular network. This command is necessary only if the automatic registration failed (AT+CEREG? returns 0,0).
AT+COFS?	+COFS: 0,0,"Verizon Wireless",7 OK	Read the operator name and radio access technology (RAT).
AT+USOCR=17	+USOCR: 0 OK	Create a UDP socket.
AT+USOST=0,"echo.u-blox.com",7,13,"TestNumberOne"	+USOST: 0,13 OK	Connecting and storing text on the server.
	+UUSORF: 0,13	Echo server returning the message.
AT+USORF=0,13	+USORF: 0,"185.215.195.137",7,13,"TestNumberOne"	Reading the message from the server.

Command sent by DTE (user)	DCE response (module)	Description
	OK	
AT+USOCL=0	OK	Closing the socket.

## C.5 Configure audio interface for earphones

The audio interface has to be configured by selecting among the available settings a combination supported by the used audio codec.

The EVK-R6001, EVK-R6401, EVK-R6801 and EVK-L6004 for the LARA-R6 and LARA-L6 modules supporting voice and data mount a Maxim Integrated MAX9860 audio voice codec and the default configuration module already matches with the setting supported by MAX9860. The user only needs to activate the audio codec

Command sent by DTE (user)	DCE response (module)	Description
AT+USPM=1,0	OK	Set the headset profile (default setting) <sup>4</sup> .
AT+UI2S=14,1,0,3,0	OK	Configures the I2S digital audio interface (default setting) (!).
AT+UGPIOC=34,12	OK	Configures the GPIO pin 34 (I2S_WA) as I2S digital audio interface (default setting) (!).
AT+UGPIOC=35,12	OK	Configures the GPIO pin 35 (I2S_TXD) as I2S digital audio interface (default setting) (!).
AT+UGPIOC=36,12	OK	Configures the GPIO pin 36 (I2S_CLK) as I2S digital audio interface (default setting) (!).
AT+UGPIOC=37,12	OK	Configures the GPIO pin 37 (I2S_RXD) as I2S digital audio interface (default setting) (!).
AT+UEXTDCONF=0	OK	Disable the audio codec and restore the default settings (!).
AT+UEXTDCONF=0,1	OK	Defines the settings to be downloaded to the Maxim MAX9860 external audio codec. If it was disabled (as per default setting), it will be enabled and configured properly. In other scenarios, AT+UEXTDCONF=0 shall have to be issued previously.
AT+UTGN=440,500,100	OK +UUTGN: 0	Play a 440 Hz tone, 0.5 s long, volume 0 dB.

<sup>4</sup> optional: this command is not needed if the module audio settings have been not changed and they have the default values.

## D Current consumption measurement

Measure the current consumption of the cellular module on the EVK-R6 and EVK-L6 by removing the jumper socket from the **Cellular VCC supply jumper** (J109 on the ADP-R6 /L6), described in [Figure 6](#).

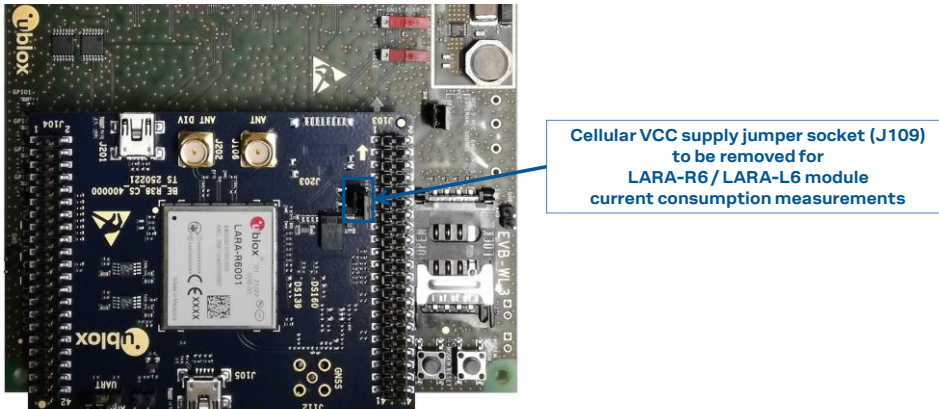

**Figure 6:** Jumper socket to be removed for cellular module's current consumption measurement

A suitable external digital multi-meter (as the Keysight 34465A, 34410A or 34411A) can be used for current consumption measurements: in this case, the 3.8 V supply circuit on the EVB will supply the cellular module, with the digital multi-meter placed in series as illustrated in [Figure 7](#).

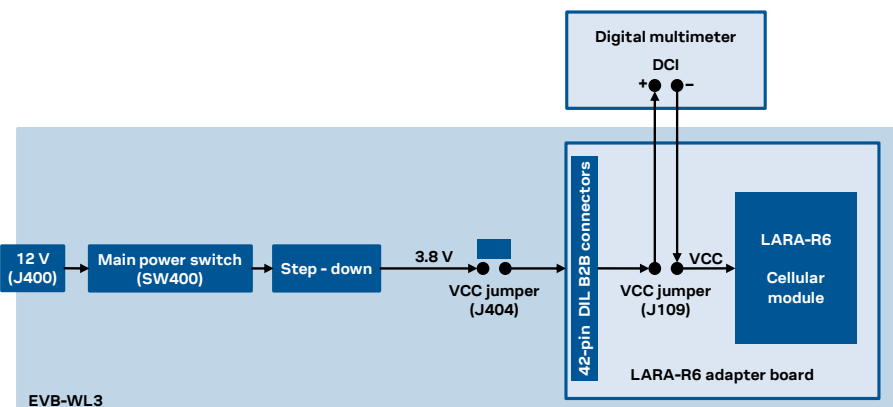

**Figure 7:** Block diagram of the setup for cellular module's current consumption measurement using a current meter

Alternatively, a suitable external DC power supply with the dynamic current measurement capabilities (as for example, the portable and cheap Qoitech Otii Arc, or the more accurate Keysight N6705B, or the models designed for mobile communications Keysight 66319B/D or 66321B/D) can be used for current consumption measurements, acting also as 3.8 V supply source for the cellular module mounted on the adapter board, as illustrated in [Figure 8](#).

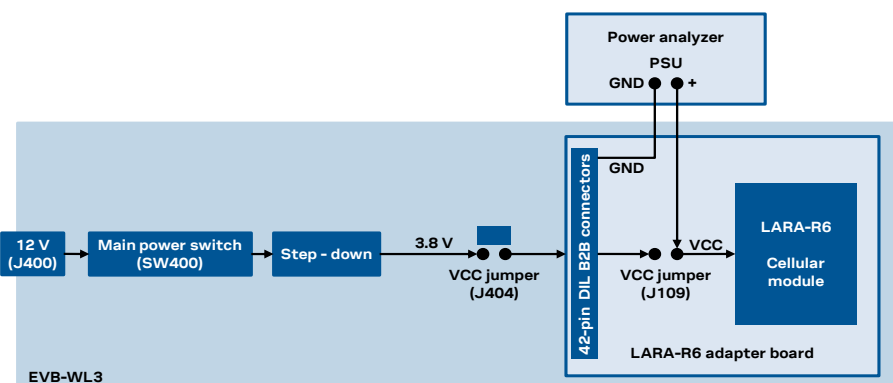

**Figure 8:** Block diagram of the setup for cellular module's current consumption measurement using a DC power analyzer

## E Glossary

Abbreviation	Definition
ADP	Adapter Board
APN	Access Point Name
AT	AT Command Interpreter Software Subsystem, or attention
B2B	Board-To-Board
CTS	Clear To Send
DCI	Direct Current
DIL	Dual In Line
EPS	Evolved Packet System
EVB	Evaluation Board
EVK	Evaluation Kit
GND	Ground
GNSS	Global Navigation Satellite System
GPIO	General Purpose Input Output
GPRS	General Packet Radio Service
IMS	IP Multimedia Subsystem
LDO	Low Drop-Out
LED	Light Emitting Diode
LTE	Long Term Evolution
NVM	Non-Volatile Memory
PIN	Personal Identification Number
PPP	Point-to-Point Protocol
PS	Packet Switch
PSU	Power Supply Unit
RAT	Radio Access Technology
RF	Radio Frequency
RI	Ring Indicator
UART	Universal Asynchronous Receiver-Transmitter
URC	Unsolicited Result Code
VCC	Voltage Common Collector

## F Declaration of conformities

The equipment is intended for indoor usage. It is the user's duty to verify if further restrictions apply, such as in airplanes, hospitals, or hazardous locations (petrol stations, refineries, etc.).

Any changes or modification made to this equipment will void its compliance to safety requirements.

Maintenance, inspections and repairs of the EVK-R6 and EVK-L6 shall be performed by u-blox AG.