

Introduction

The evaluation board is designed to help the customer evaluate the 9FGV1001, 9FGV1002, and 9FGV1004 devices. When the board is connected to a PC running IDT [Timing Commander™](#) software through USB, the device can be configured and programmed to generate different combinations of frequencies.

Board Overview

Use [Figure 1](#) and [Table 1](#) to identify: power supply jacks, USB connector, input and output frequency SMA connectors.

Figure 1. Evaluation Board Overview

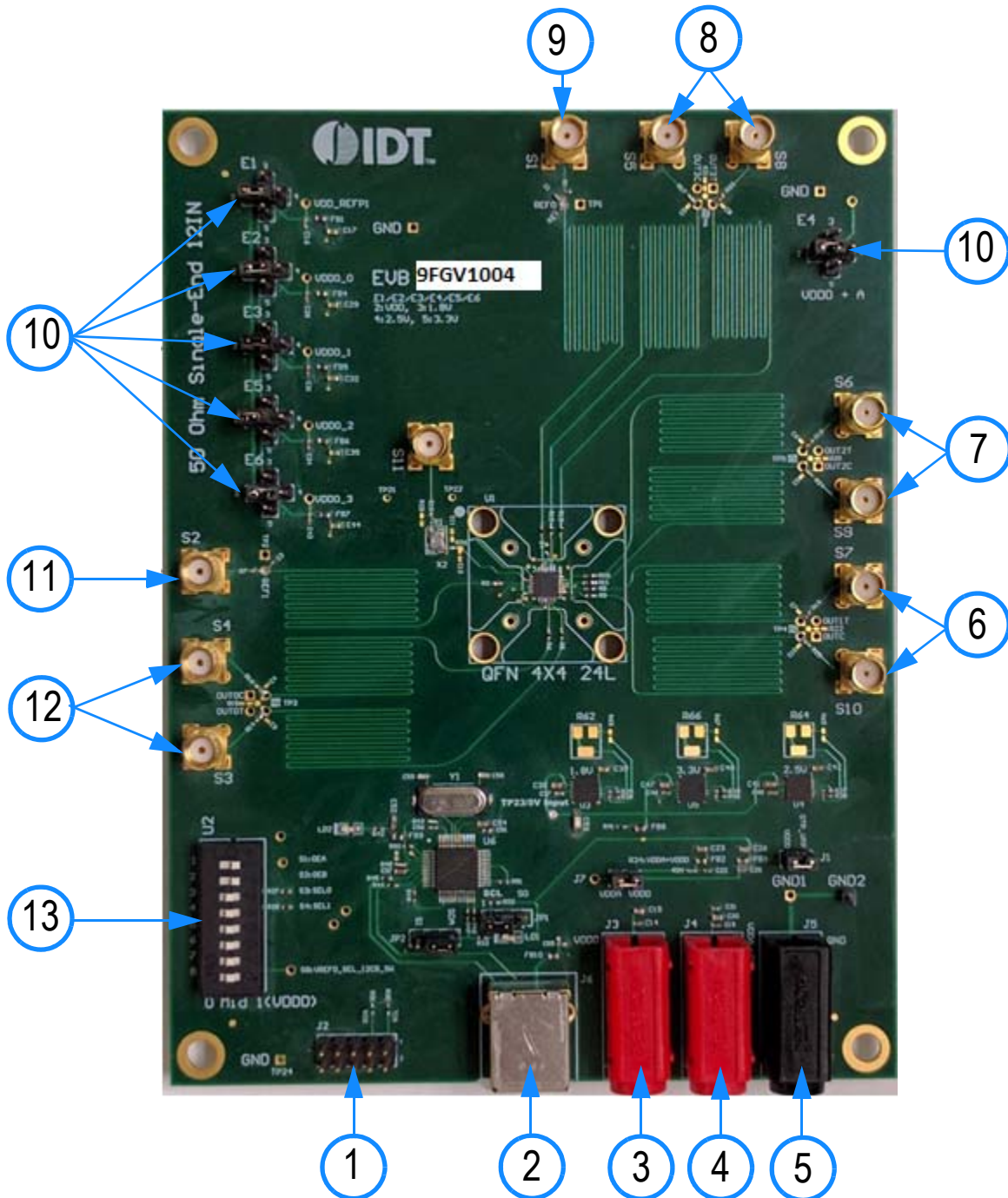

Table 1. Evaluation Board Pins and Functions

Label Number	Name	On-board Connector Label	Function
1	I ² C Interface Connector	J2	Alternative I ² C interface connector for Aardvark. IDT Timing Commander can also use Aardvark.
2	USB Connector	J6	Connect this USB to your PC to run IDT Timing Commander. The board can be powered from the USB port.
3	Output Power Supply Jack	J3	Connect to 1.8V, 2.5V or 3.3V for the output voltage of the device.
4	Core Power Supply Jack	J4	Connect to 1.8V, 2.5V or 3.3V for the core voltage of the device.
5	Ground Jack	J5	Connect to ground of power supply.
6	Differential Output 1	S7 and S10	Can be a differential pair, or two single-ended outputs. Available logic types: LVCMOS, LVDS and LP-HCSL.
7	Differential Output 2	S6 and S9	Can be a differential pair, or two single-ended outputs. Available logic types: LVCMOS, LVDS and LP-HCSL.
8	Differential Output 3	S5 and S8	Can be a differential pair, or two single-ended outputs. Available logic types: LVCMOS, LVDS and LP-HCSL.
9	Reference Output 0	S1	Reference or buffered output from the crystal.
10	Power Supply Voltage Selector	E1, E2, E3, E4, E5, E6	VDD_REFP1, VDDO_0, VDDO_1, four-way headers used to select a power supply voltage. Connect the center pin to one of the 4 surrounding pins to select a voltage or a source.
11	Reference Output 1	S2	Reference or buffered output from the crystal.
12	Differential Output 0	S3 and S4	Can be a differential pair, or two single-ended outputs. Available logic types: LVCMOS, LVDS and LP-HCSL.
13	DIP Switch	U2	Used to control certain pins like OEA, OEB, SEL0, SEL1 and I ² C versus Hardware Select mode.

Board Power Supply

The evaluation board uses jumpers E1–E6 to set the power supply voltages for various V_{DD} pins. The 4-way jumpers can select 3 different voltages from regulators that use power from the USB port. Selection #2 is the jack for connecting a bench power supply.

E1: Power supply for the REF outputs. The E1 voltage also determines the LVCMOS output levels of the REF0 and REF1 outputs.

E2: Power supply for the OUT0 output driver.

E3: Power supply for the OUT1 output driver.

E4: Power supply for the analog (V_{DDA}) and digital (V_{DDD}) core V_{DD} pins.

E5: Power supply for the OUT2 output driver.

E6: Power supply for the OUT3 output driver.

See *9FGV100x Evaluation Board Schematics* (Figure 5–Figure 8) for detailed information.

DIP Switch (U2)

Refer to [Figure 2](#) and [Table 2](#) for the DIP switch settings and functions.

Figure 2. DIP Switch (U2)

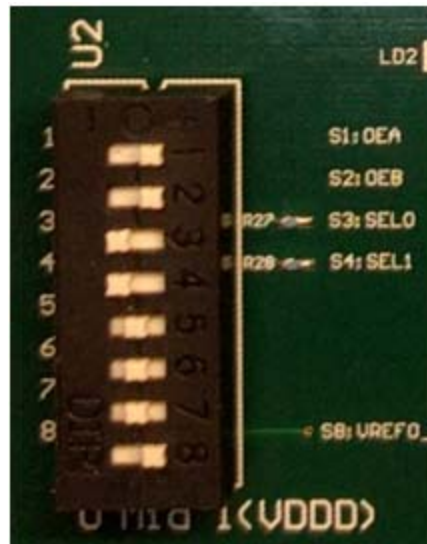

Table 2. DIP Switch Settings

Switch Number	Function
1 = OEA	See datasheet.
2 = OEB	
3 = SEL0	Select 1 of 4 pre-programmed configurations when in Hardware Select mode. Also see switch 8.
4 = SEL1	
5	Not used.
6	Not used.
7	Not used.
8 = Mode	Selects operating mode at power-up. “-” or “0” selects I ² C mode. “+” selects Hardware Select mode.

Interfacing with a Computer to Run Timing Commander

As shown in [Figure 3](#), jumpers JP1 and JP2 are installed to use the FTDI chip U6 for connecting to the computer with the USB port J6. The U6 chip translates USB to I²C.

When using Aardvark, remove jumpers JP1 and JP2 and connect the Aardvark to connector J2. Default I²C device address for the 9FGV100x is 0x68.

Miscellaneous interfaces can connect to J2 pin 1 for the Serial Clock and to J2 pin 3 for the Serial Data signal. J2 pin 2 can be used as ground, but any other ground pin will also work.

When OTP in the 9FGV100x devices is burned with multiple configurations, JP1 and JP2 can be applied in JP3 position respectively to connect the SEL0 and SEL1 switches in U2. Move switch 8 to “+” and power-up the 9FGV100x in Hardware Select mode. This enables changing between 4 configurations with SEL0/1.

Figure 3. Connecting to a Computer via USB Port J6

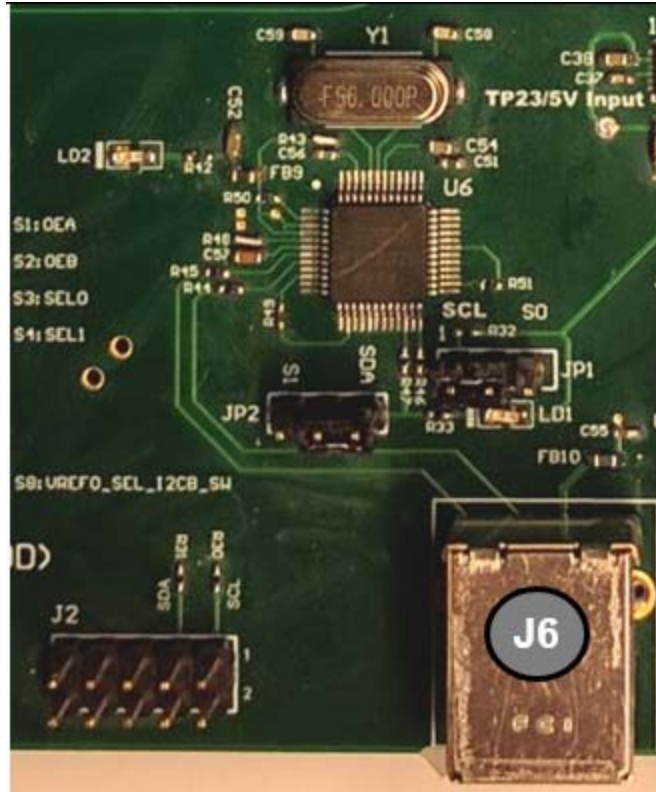

On-board Crystal

A 25MHz crystal is installed on the board and is used as the reference frequency. The board can also be modified to insert an external reference clock into the XIN pin using SMA connector S11. When using an external reference clock, additional components need to be assembled and the crystal needs to be removed.

Output Terminations



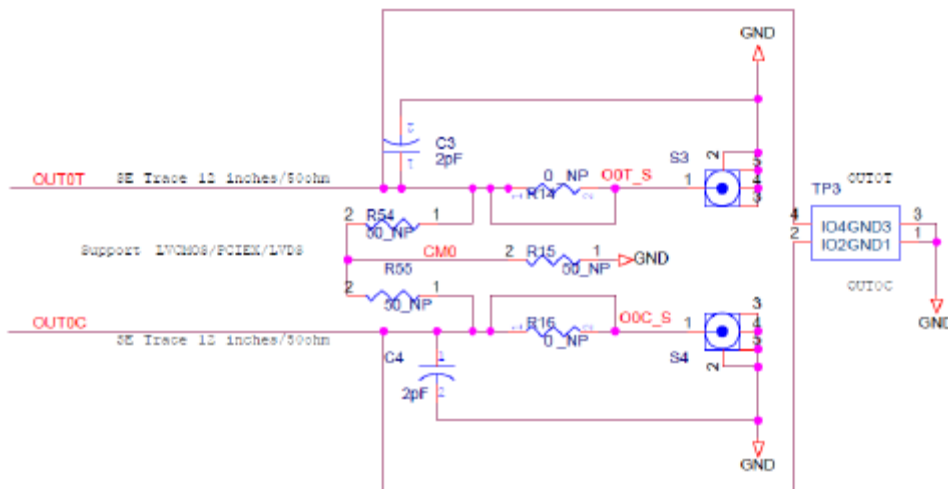

Each differential output has a pair of SMA connectors to connect to a 50Ω coax. It is recommended to combine the two signals using a balun or splitter/combiner device when measuring jitter or phase noise. The circuit at the SMA connectors is shown in [Figure 4](#).

Figure 4. SMA Connectors Circuit



The circuit is designed for maximum flexibility when testing all possible logic types. Default assembly uses a 0.1 μ F capacitor in place of R14 and R16, and the short across R14 and R16 is cut. No other devices are assembled. This simple AC-coupled configuration allows for testing phase noise and jitter of all possible logic types. The circuit can be modified for custom tests. TP3 is a position to place a differential FET probe.

Operating Instructions

1. Set all jumpers for power supply choices (E1–E6), interface choices (JP1 and JP2), and set the U2 switches.
2. Connect an interface: USB or I²C.
3. In the case of an I²C interface, also connect external power supply to jacks J3, J4 and J5.
4. Start Timing Commander for either USB or Aardvark.
 - a. Start new configuration or load TCS file for existing configuration.
 - b. Choose PhiClock personality.
 - c. For Aardvark, click  to select Aardvark “Connection Interface”.
 - d. For a new configuration, prepare all settings.
 - e. Click  to connect to the 9FGV100x device. Top right should turn green. 
 - f. Click  to write all settings to the 9FGV100x device.
 - g. It should now be possible to measure clocks on outputs.
 - h. While connected, each change to the settings will be written to the 9FGV100x immediately and can be observed at the clock outputs.

Schematics

Figure 5. 9FGV100x Evaluation Board Schematic - page 1

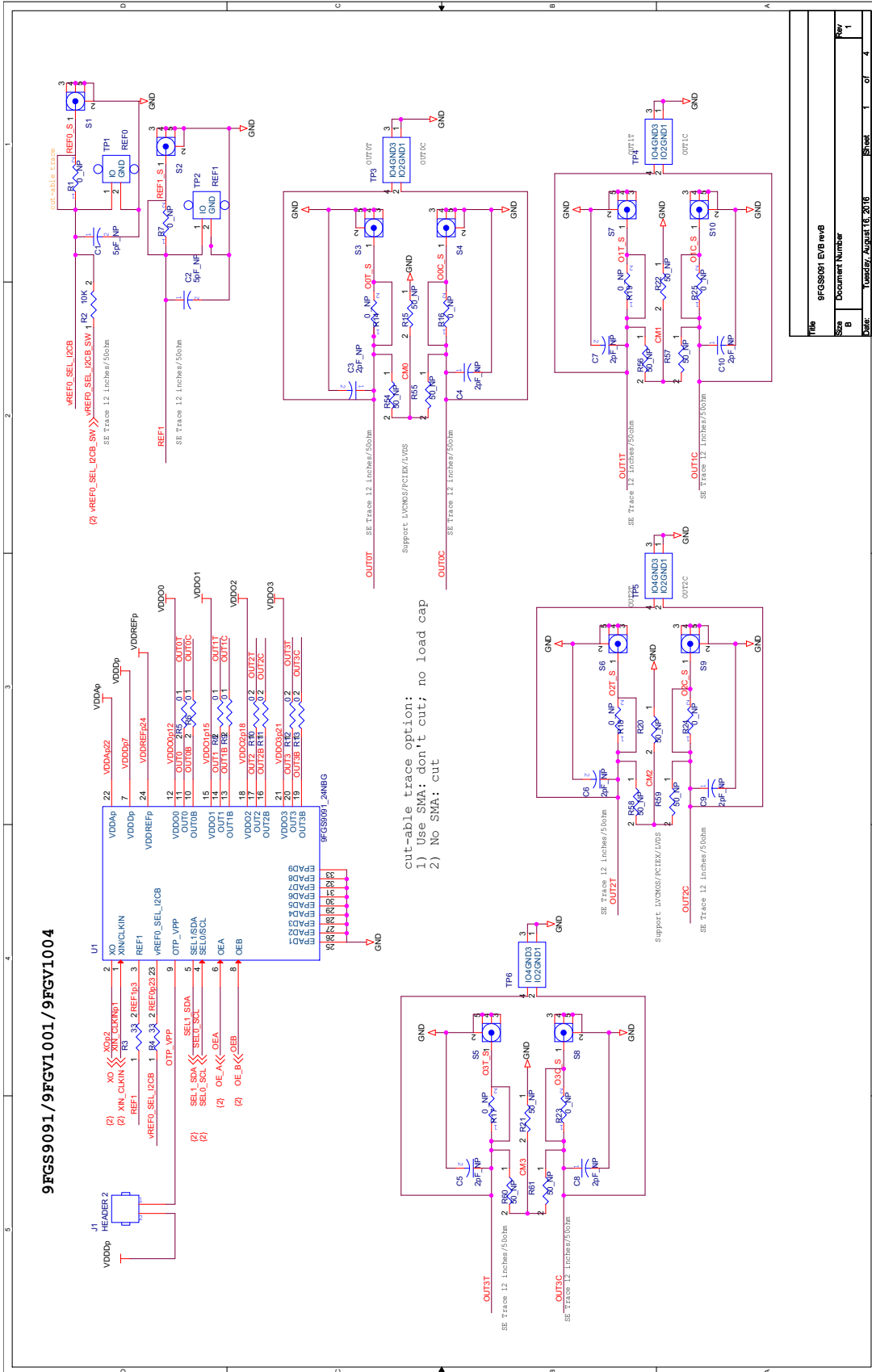

Figure 6. 9FGV100x Evaluation Board Schematic - page 2

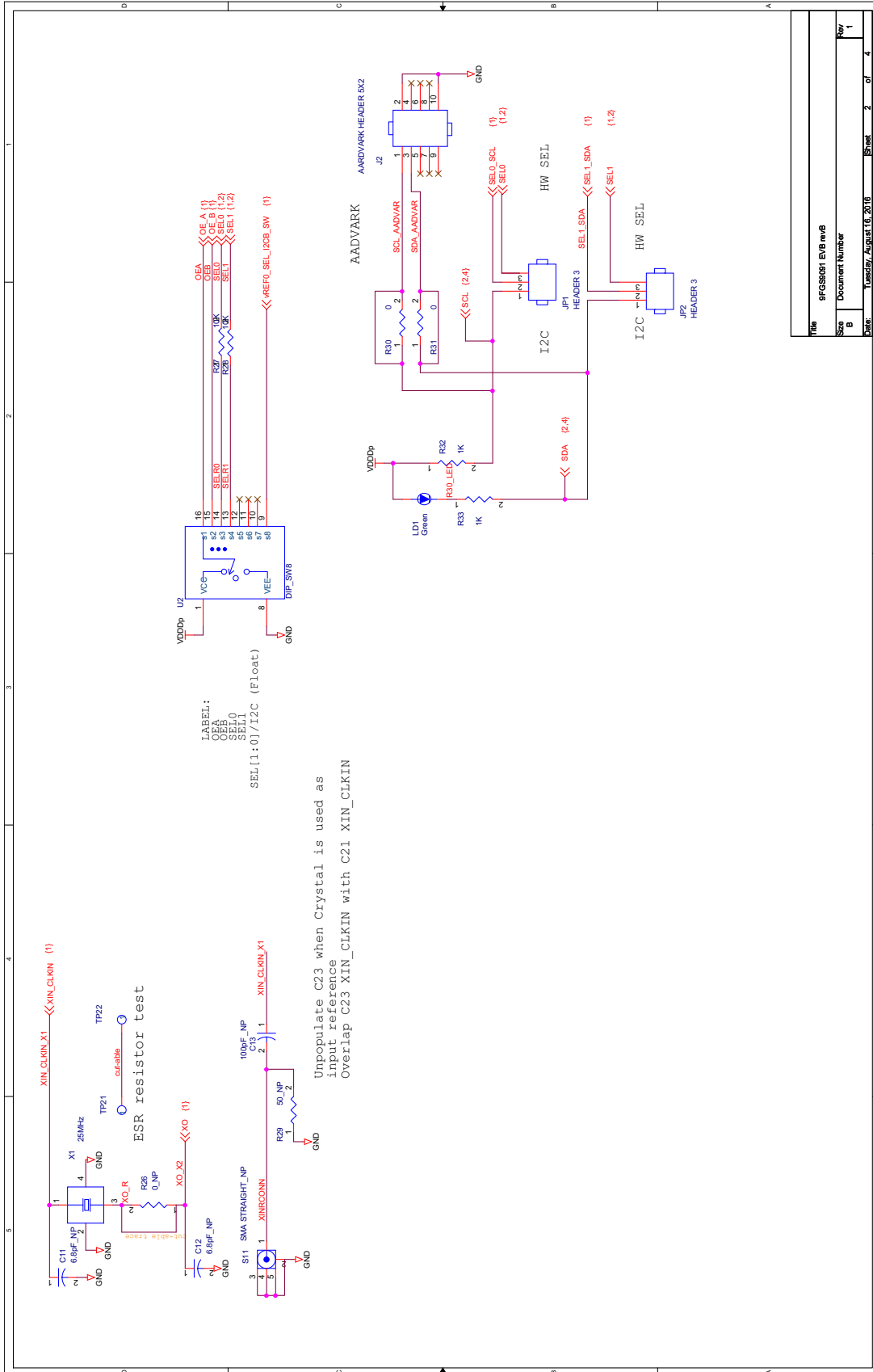

Figure 7. 9FGV100x Evaluation Board Schematic - page 3

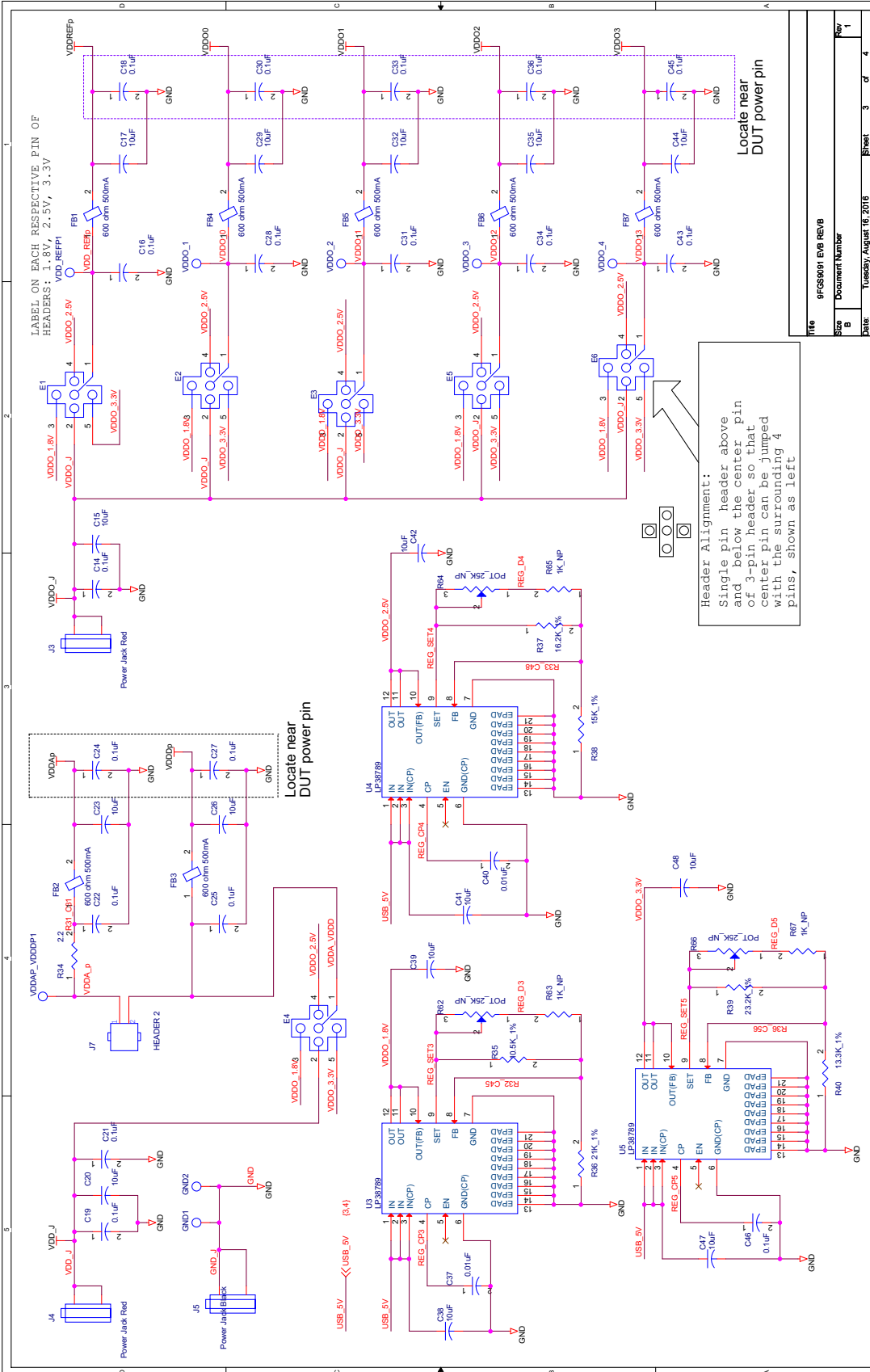
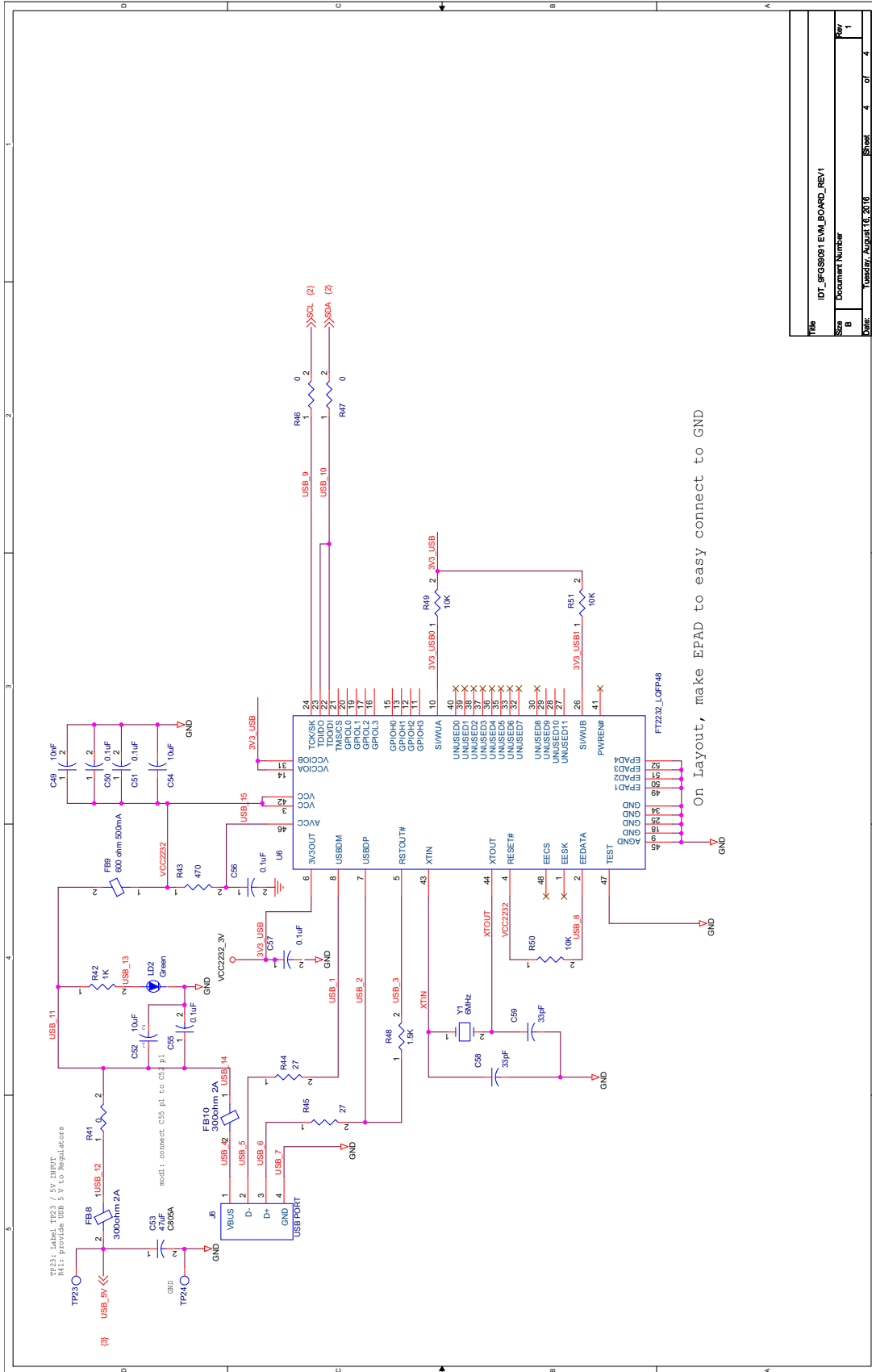

Figure 8. 9FGV100x Evaluation Board Schematic - page 4



File	IDT_SF08081 EVAL_BOARD_REV1
Size	Document Number
Rev	1
Date	1/25/2018
Page	4 of 4

Ordering Information

Orderable Part Number	Description
EVK9FGV1001	Evaluation board with all differential outputs AC coupled.
EVK9FGV1002	
EVK9FGV1004	

Revision History

Revision Date	Description of Change
March 1, 2018	Initial release.