

DESCRIPTION

The EVM3510A-QV-00A is an evaluation board for MPM3510A, a synchronous rectified, step-down Mini-Module regulator with built-in power MOSFETS, inductor and two capacitors.

The Evaluation Board can deliver a 1.2A continuous output current with excellent load and line regulation over a wide input supply range.

Full protection features include over-current protection and thermal shut down.

The MPM3510A is available in a space-saving QFN-19 (3mmx5mmx1.6mm) package.

ELECTRICAL SPECIFICATION

Parameter	Symbol	Value	Units
Input Voltage	V_{IN}	4.5-36	V
Output Voltage	V_{OUT}	3.3	V
Output Current	I_{OUT}	1.2	A

FEATURES

- Complete Switch Mode Power Supply
- 4.5V-to-36V Wide Operating Input Range
- 1.2A Continuous Load Current
- Low $R_{DS(ON)}$ Internal Power MOSFETS
- Fixed 1.15MHz Switching Frequency
- 800kHz-2MHz Frequency Sync
- Power Save Mode for Light Load
- Power Good Indicator
- OCP Protection with Valley Current detection and Hiccup
- Thermal Shutdown
- Output Adjustable from 0.8V
- Available in QFN-19 (3x5x1.6mm) Package

APPLICATIONS

- Industrial Controls
- Automotive
- Medical and Imaging Equipment
- Telecom Applications
- LDO Replacement
- Space and Resource-limited Applications
- Distributed Power Systems

All MPS parts are lead-free, halogen free, and adhere to the RoHS directive. For MPS green status, please visit MPS website under Quality Assurance. "MPS" and "The Future of Analog IC Technology" are Registered Trademarks of Monolithic Power Systems, Inc.

EVM3510A-QV-00A EVALUTION BOARD

(L x W x H) 6.35cm x 6.35cm x 0.3cm

Board Number	MPS IC Number
EVM3510A-QV-00A	MPM3510AGQV

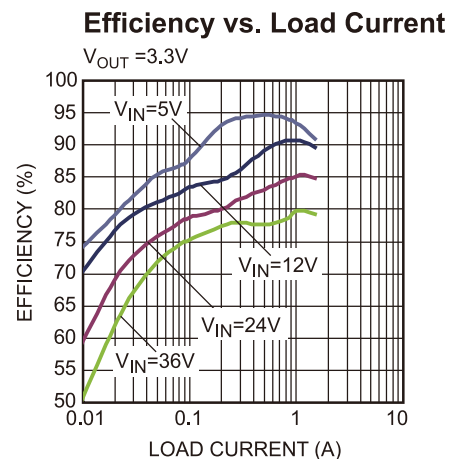

EVALUATION BOARD SCHEMATIC

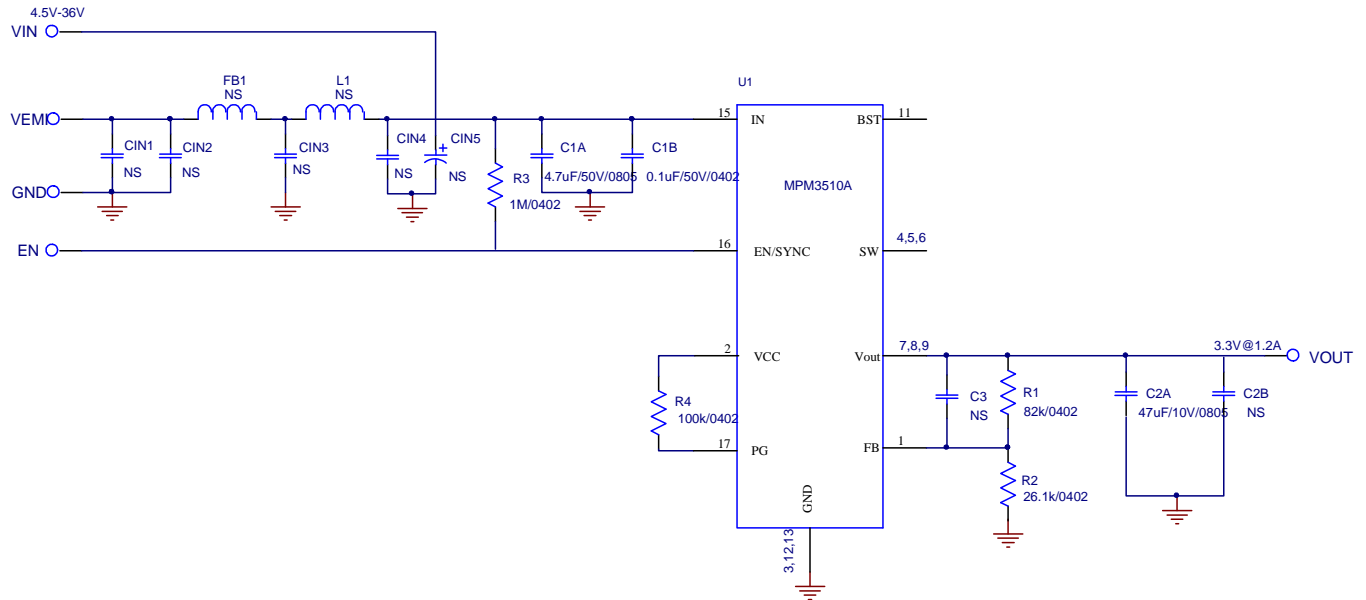

EVM3510A-QV-00A BILL OF MATERIALS

Qty	RefDes	Value	Description	Package	Manufacturer	Manufacturer_P/N
1	C1A	4.7uF	Ceramic Cap., 50V, X7R	0805	muRata	GRM21BC71H475KE1
1	C1B	0.1uF	Ceramic Cap., 50V, X7R	0402	TDK	C1005X7R1C104K
1	C2A	47uF	Ceramic Cap., 10V, X5R	0805	muRata	GRM21BR61A476ME15L
7	C2B, CIN1, CIN2, CIN3, CIN4, CIN5, C3	NS				
1	R1	82k	Film Res., 1%	0402	Yageo	RC0402FR-0782KL
1	R2	26.1k	Film Res., 1%	0402	Yageo	RC0402FR-0726K1L
1	R3	1M	Film Res., 5%	0402	Yageo	RC0402JR-071ML
1	R4	100k	Film Res., 1%	0402	Yageo	RC0402FR-07100KL
1	FB1	NS				
1	L1	NS				
1	U1		module		MPS	MPM3510A

EVB TEST RESULTS

Performance waveforms are tested on the evaluation board.

$V_{IN} = 24V$, $V_{OUT} = 3.3V$, $T_A = 25^\circ C$, unless otherwise noted.

Output Ripple

$I_{OUT} = 0A$

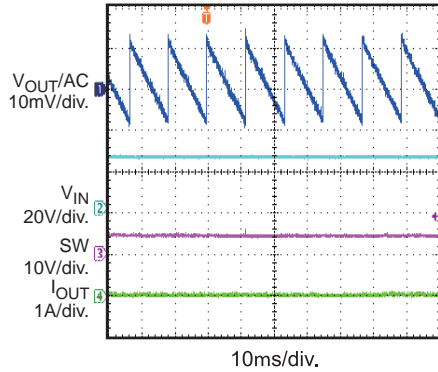

Output Ripple

$I_{OUT} = 1.2A$

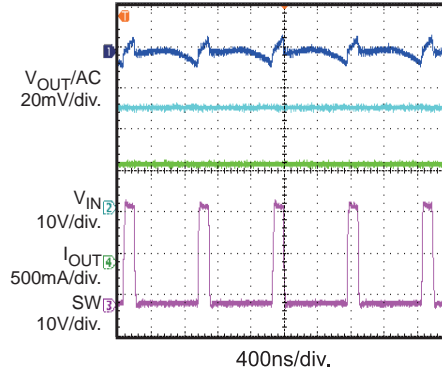

V_{IN} Startup

$I_{OUT} = 0A$

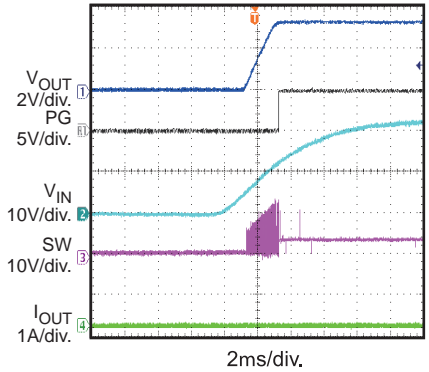

V_{IN} Startup

$I_{OUT} = 1.2A$

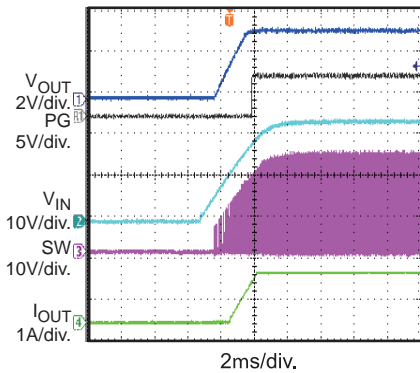

V_{IN} Shutdown

$I_{OUT} = 0A$

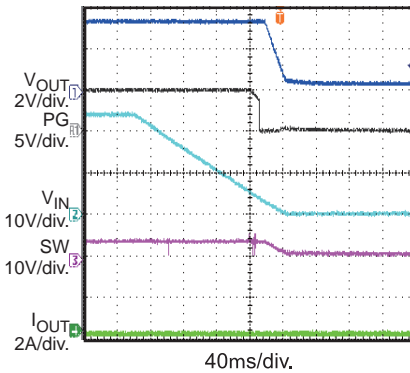

V_{IN} Shutdown

$I_{OUT} = 1.2A$

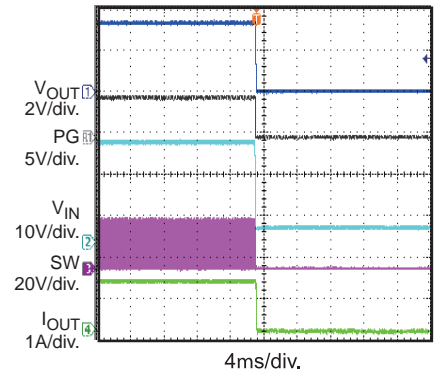

EN Startup

$I_{OUT} = 0A$

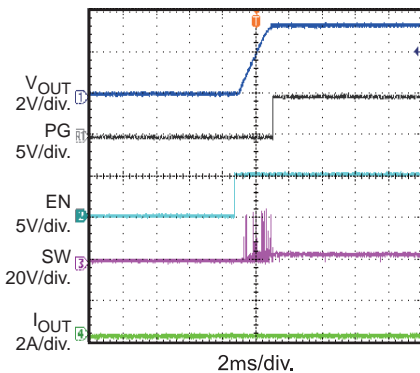

EN Startup

$I_{OUT} = 1.2A$

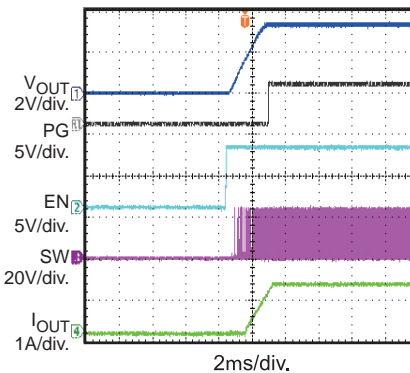

EN Shutdown

$I_{OUT} = 0A$

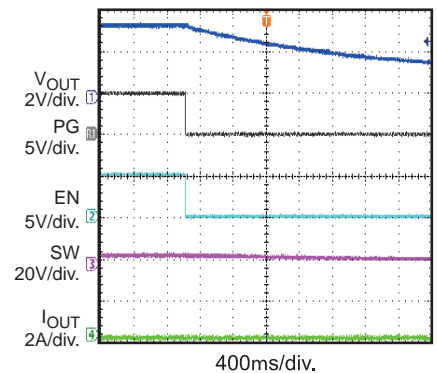

EVB TEST RESULTS

Performance waveforms are tested on the evaluation board.

$V_{IN} = 24V$, $V_{OUT} = 3.3V$, $T_A = 25^\circ C$, unless otherwise noted.

EN Shutdown

$I_{OUT} = 1.2A$

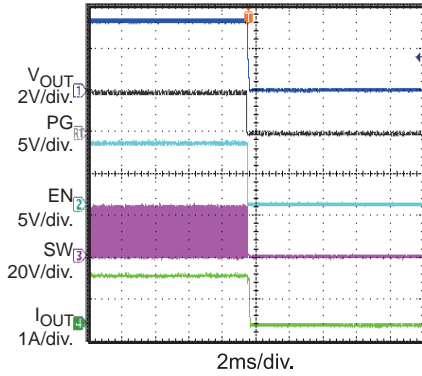

Load Transient

$I_{OUT} = 0A-1.2A$

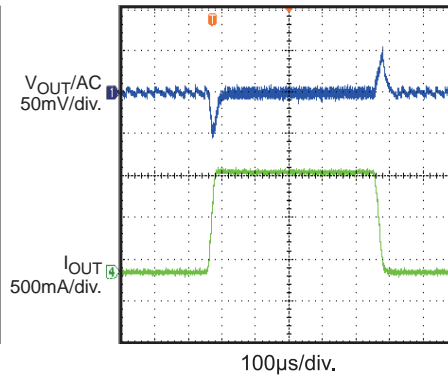

SCP Steady State

$I_{OUT} = 0A$

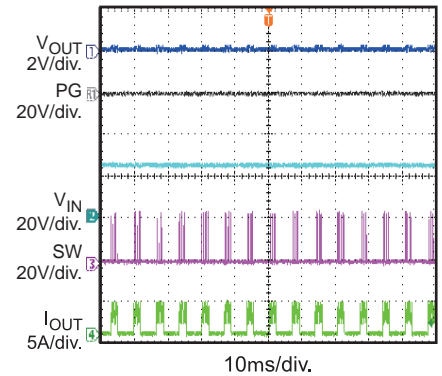

SCP Entry

$I_{OUT} = 0A$

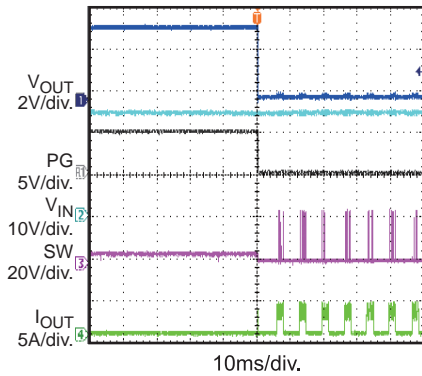

SCP Recovery

$I_{OUT} = 0A$

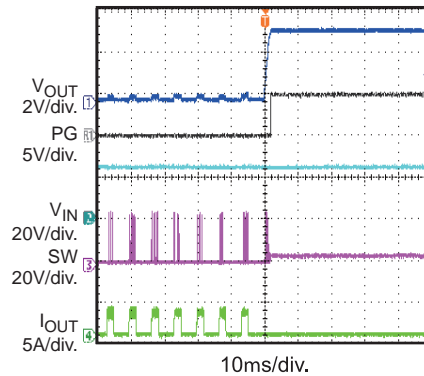

PRINTED CIRCUIT BOARD LAYOUT

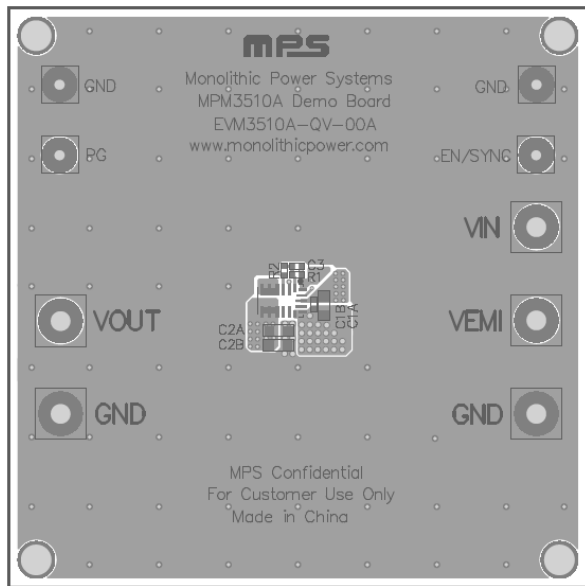

Figure 1-Top Silk Layer & Top layer

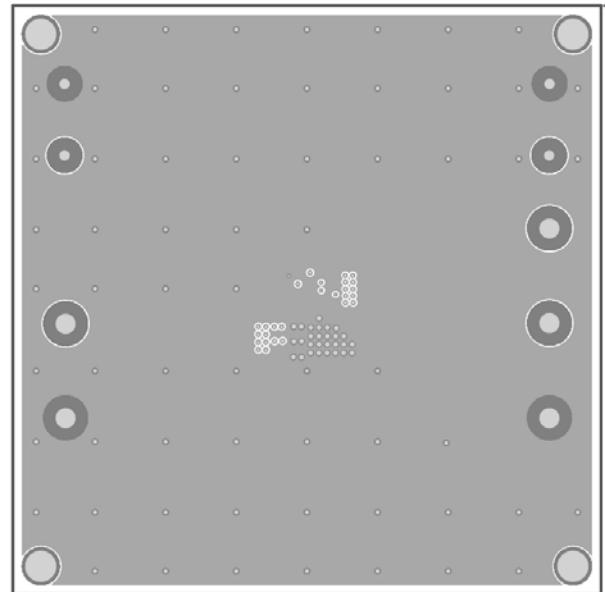

Figure 2-IN1 Layer

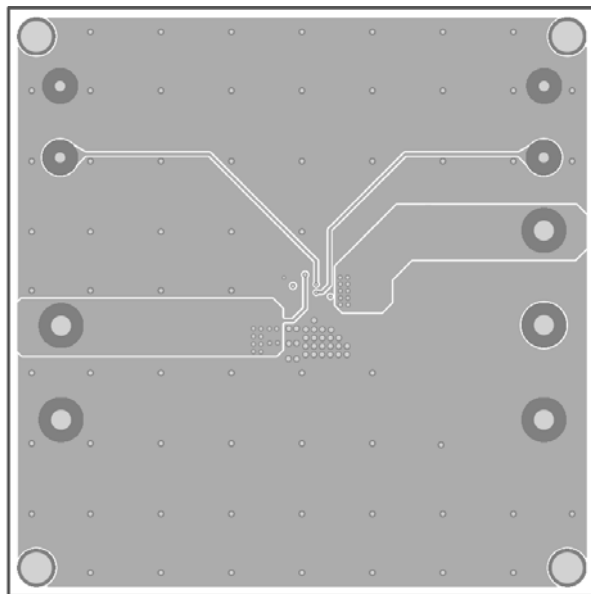

Figure 3-IN2 Layer

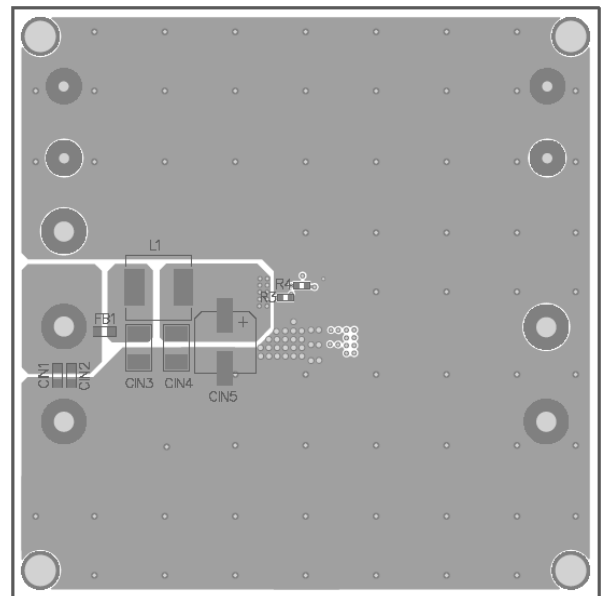

Figure 4-Bottom Silk Layer & Bottom Layer