

DESCRIPTION

The EVM3810A-QB-00A is used for demonstrating the performance of MPS's MPM3810A a low voltage high switching frequency step-down switcher with built-in power MOSFETs and power inductor. MPM3810A provides up to 1.2A peak highly efficient output with constant-on-time control for fast loop response.

The constant-on-time control (COT) scheme provides fast, transient response loop stabilization. Fault condition protection includes cycle-by cycle current limiting and thermal shutdown (TSD).

The MPM3810A is available in QFN 3.0x2.5x0.9mm package.

ELECTRICAL SPECIFICATION

Parameter	Symbol	Value	Units
Input Voltage	V _{IN}	2.5– 6	V
Output Voltage	V _{OUT}	1.2	V
Output Current	I _{OUT}	1.2	A

FEATURES

- Wide 2.5V to 6V Operating Input Range
- Adjustable output from 0.6V
- 3mm x 2.5mm x 0.9mm QFN Package
- Total Solution Size 6mm x 3.8mm
- Up to 1.2A Peak Output Current
- 100% Duty Cycle in Dropout
- Force CCM Mode
- EN and Power Good for Power Sequencing
- Cycle-by-Cycle Over-Current Protection
- Short Circuit Protection with Hiccup Mode
- Adjustable Output Only Needs 4 External Components - 2 Ceramic Capacitors and FB Divider Resistors

APPLICATIONS

- Automotive ECU
- Low Voltage I/O System Power
- LDO Replacement
- Power for Portable Products
- Telematics
- Space-limited Applications

All MPS parts are lead-free and adhere to the RoHS directive. For MPS green status, please visit MPS website under Quality Assurance. "MPS" and "The Future of Analog IC Technology", are Registered Trademarks of Monolithic Power Systems, Inc.

EVM3810A-QB-00A EVALUATION BOARD



Board Number	MPS IC Number
EVM3810A-QB-00A	MPM3810AGQB

Efficiency vs. Load

V_{OUT}=1.2V

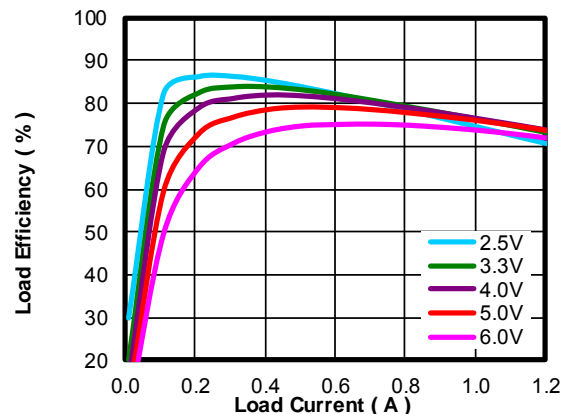

EVALUATION BOARD SCHEMATIC

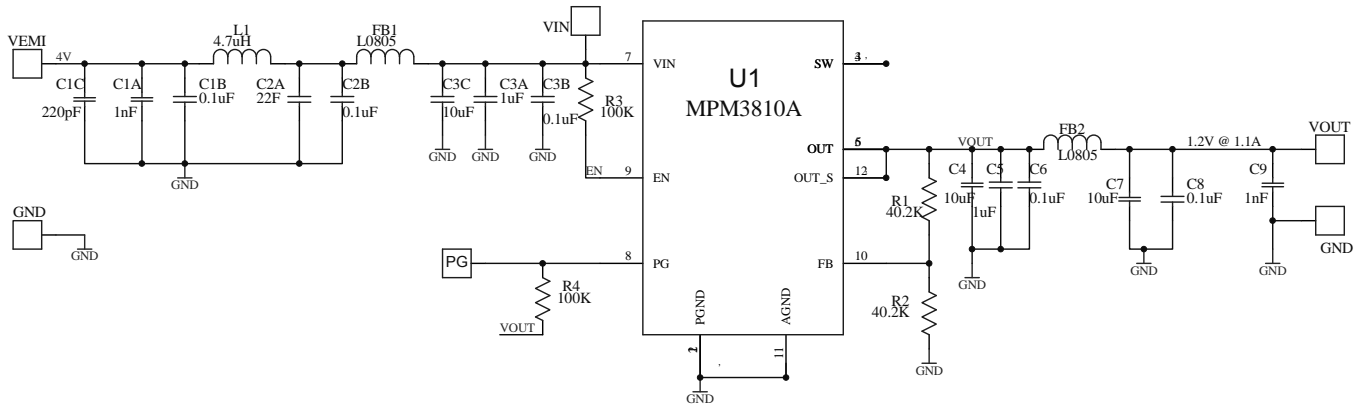

V _{OUT} (V)	R1 (kΩ)	R2 (kΩ)
1.0	40(1%)	60(1%)
1.2	40(1%)	40(1%)
1.8	60(1%)	30(1%)
2.5	80(1%)	25(1%)
3.3	80(1%)	17.7(1%)

EVM3810A-QB-00A BILL OF MATERIALS

Qty	RefDes	Value	Description	Package	Manufacturer	Manufacturer_P/N
1	C1C	220pF	Ceramic Capacitor;50V;X7R	0402	muRata	GCM155R71H221KA37D
2	C1A, C9	1nF	Ceramic Capacitor;50V;X7R	0402	muRata	GRM155R71H102KA01D
5	C1B, C2B, C3B, C6, C8	0.1µF	Ceramic Capacitor;16V;X7R	0603	muRata	GRM188R71C104KA01D
1	C2A	22µF	Ceramic Capacitor;10V;X5R	0805	muRata	GRM219R61A226MEA0D
3	C3C, C4, C7	10µF	Ceramic Capacitor;16V;X5R	0805	muRata	GRM21BR61C106KE15L
2	C3A, C5,	1µF	Ceramic Capacitor;10V;X5R	0603	muRata	GRM188R61A105KA61D
1	L1	4.7µH	Inductor 2A, 0.2Ω (2.5 x 2.0)mm	1008	muRata	DFE252012P-4R7M=P2
2	FB1, FB2		Ferrite Beeds 3A, 60mΩ	0805	Würth	742792063
2	R1, R2	40.2k	Film Res.,1%	0402	Any	
2	R3, R4	100K	Film Res.,1%	0402	Any	
1	U1	MPM3810A	COT Buck	QFN3.0*2.5	MPS	MPM3810A-GQB
1	PG	Test Point			HZ	
5	VIN, GND, VEMI, VOUT, GND	Test Point	2.0 Golden Pin		HZ	

EVB TEST RESULTS

Performance waveforms are tested on the evaluation board. $T_A = 25^\circ\text{C}$, unless otherwise noted.

Efficiency vs. Load

$V_{OUT}=1.2\text{V}$

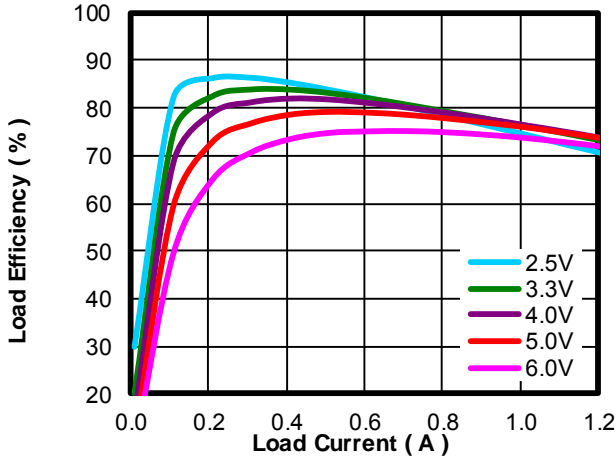

Efficiency vs. Input

$V_{OUT}=1.2\text{V}$

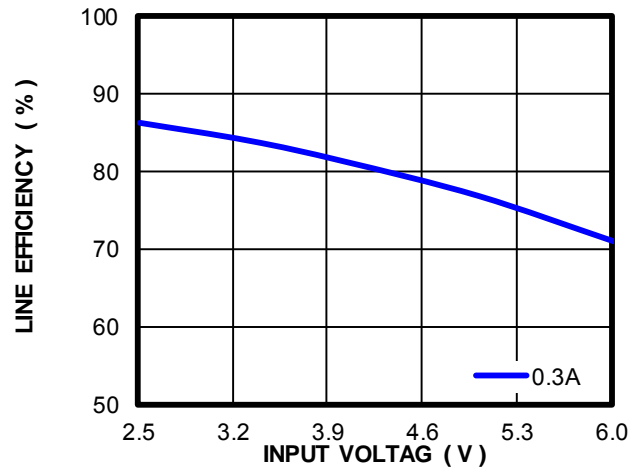

Load regulation

$V_{OUT}=1.2\text{V}$

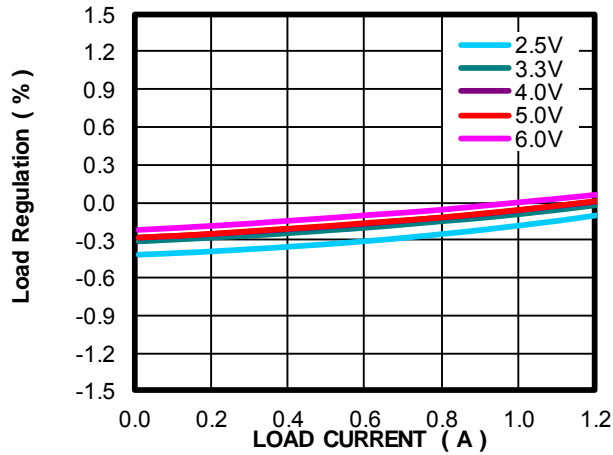

Line Regulation

$V_{OUT}=1.2\text{V}$

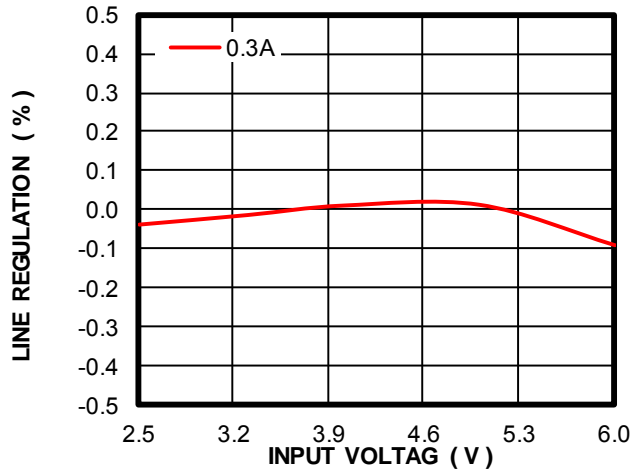

Efficiency vs. Load

$V_{OUT}=1.8\text{V}$

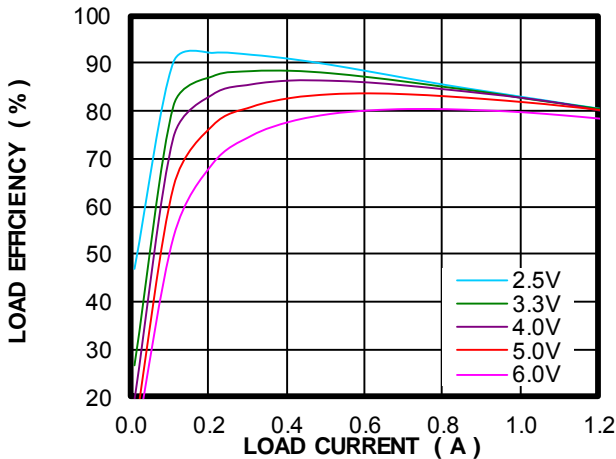

Efficiency vs. Input

$V_{OUT}=1.8\text{V}$

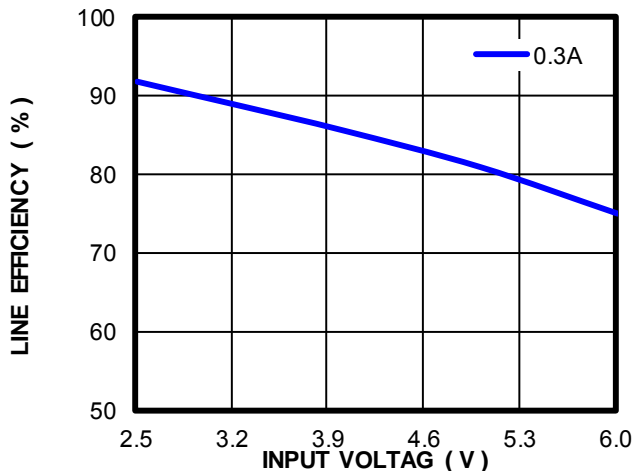

EVB TEST RESULTS

Performance waveforms are tested on the evaluation board. $T_A = 25^\circ\text{C}$, unless otherwise noted.

Load regulation

$V_{OUT}=1.8\text{V}$

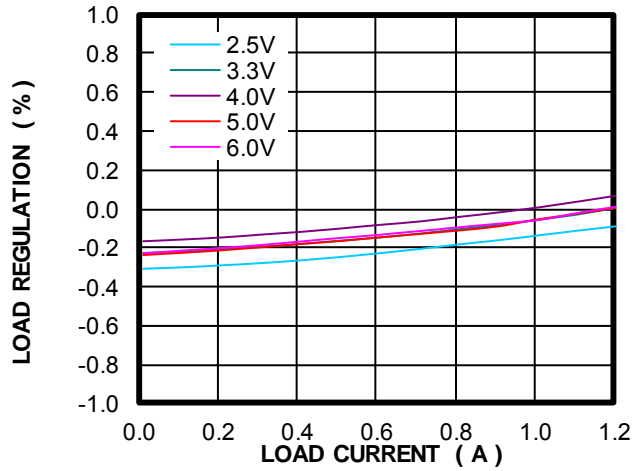

Line Regulation

$V_{OUT}=1.8\text{V}$

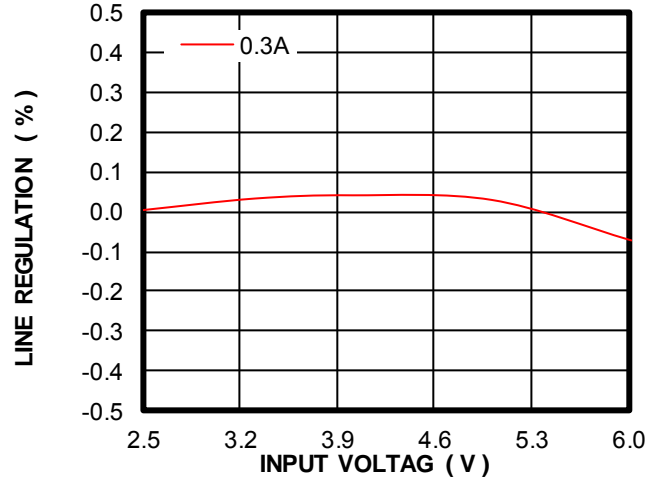

Shut Down Current vs. VIN

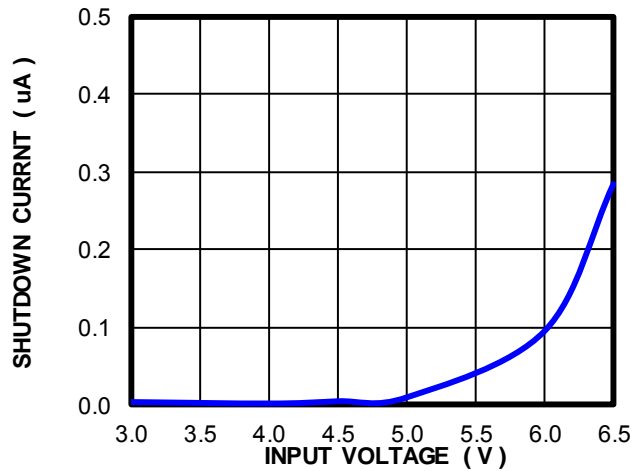

EVB TEST RESULTS

Performance waveforms are tested on the evaluation board. $T_A = 25^\circ\text{C}$, unless otherwise noted.

Steady State

$V_{IN}=5\text{V}$, $V_{OUT}=1.2\text{V}$, $I_{OUT}=0.1\text{A}$

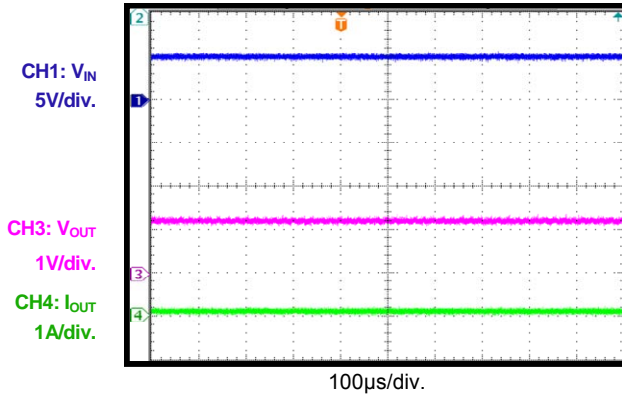

Steady State

$V_{IN}=5\text{V}$, $V_{OUT}=1.2\text{V}$, $I_{OUT}=0.6\text{A}$

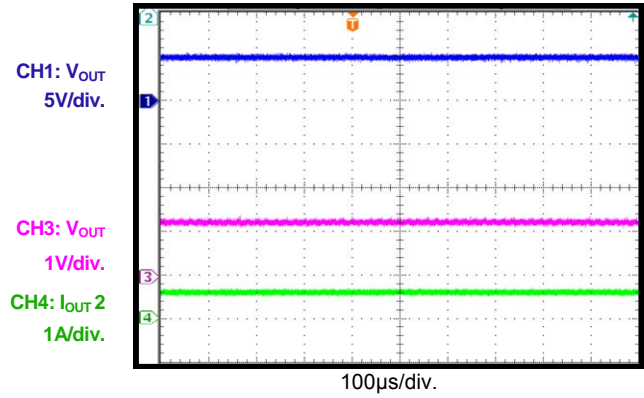

Steady State

$V_{IN}=5\text{V}$, $V_{OUT}=1.8\text{V}$, $I_{OUT}=1.2\text{A}$

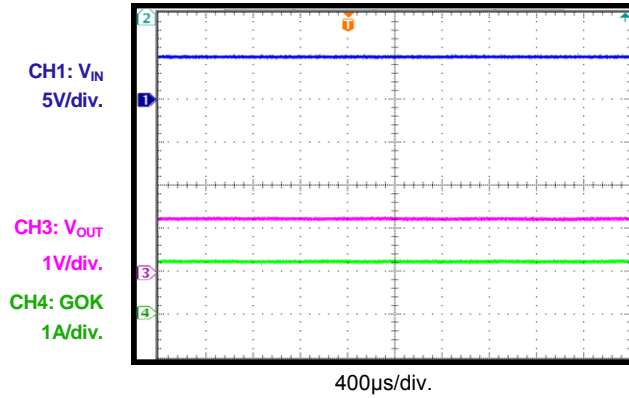

Steady State

$V_{IN}=5\text{V}$, $V_{OUT}=1.8\text{V}$, $I_{OUT}=0.1\text{A}$

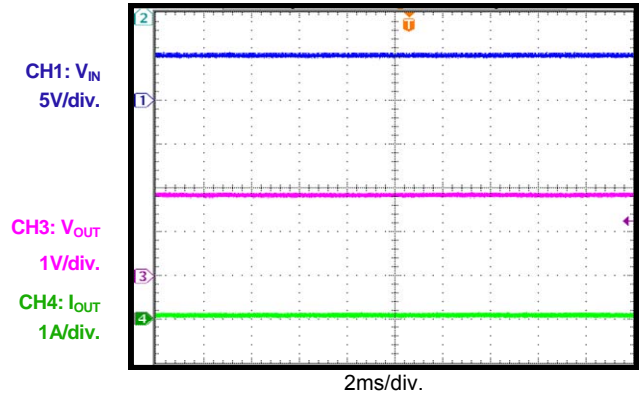

Steady State

$V_{IN}=5\text{V}$, $V_{OUT}=1.8\text{V}$, $I_{OUT}=0.6\text{A}$

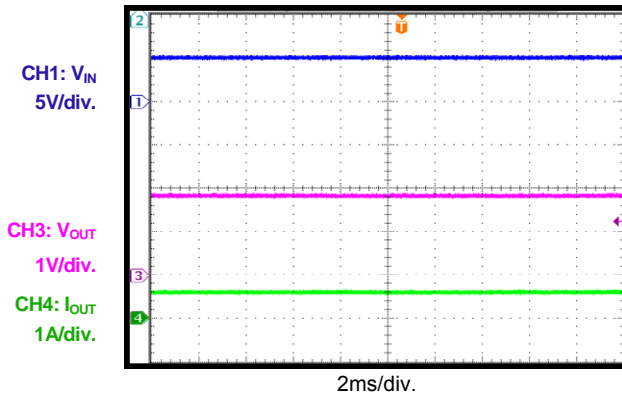

Steady State

$V_{IN}=5\text{V}$, $V_{OUT}=1.8\text{V}$, $I_{OUT}=1.2\text{A}$

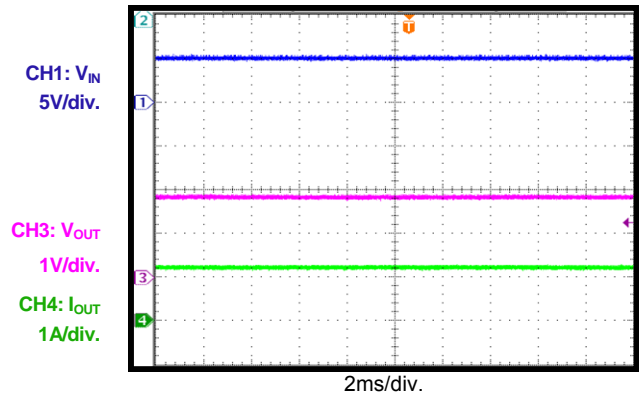

EVB TEST RESULTS (continued)

Performance waveforms are tested on the evaluation board. $T_A = 25^\circ\text{C}$, unless otherwise noted.

Power Up

$V_{IN}=2.5\text{V}$, $V_{OUT}=1.2\text{V}$, $I_{OUT}=0.6\text{A}$

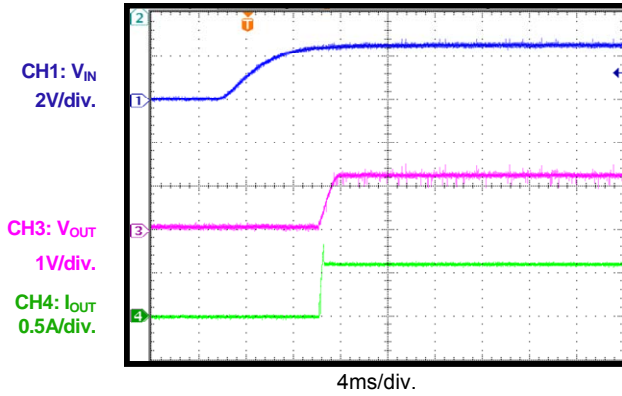

Power Down

$V_{IN}=2.5\text{V}$, $V_{OUT}=1.2\text{V}$, $I_{OUT}=0.6\text{A}$

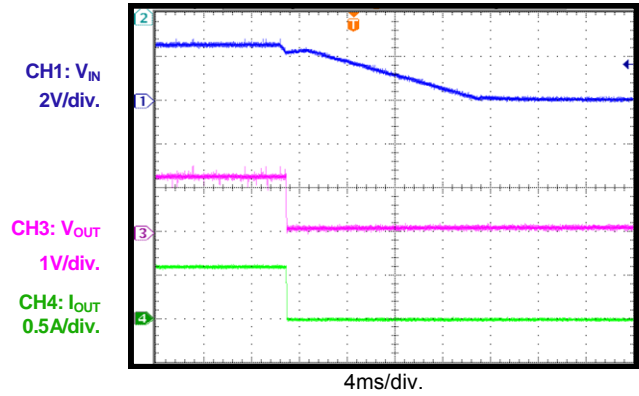

Power Up

$V_{IN}=3.3\text{V}$, $V_{OUT}=1.8\text{V}$, $I_{OUT}=0.6\text{A}$

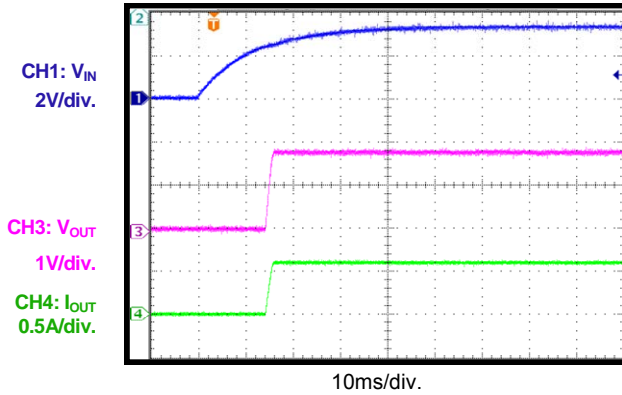

Power Down

$V_{IN}=3.3\text{V}$, $V_{OUT}=1.8\text{V}$, $I_{OUT}=0.6\text{A}$

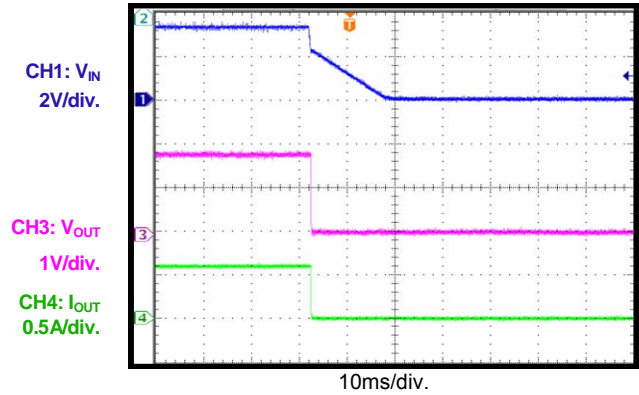

Enable On

$V_{IN}=2.5\text{V}$, $V_{OUT}=1.2\text{V}$, $I_{OUT}=0.6\text{A}$

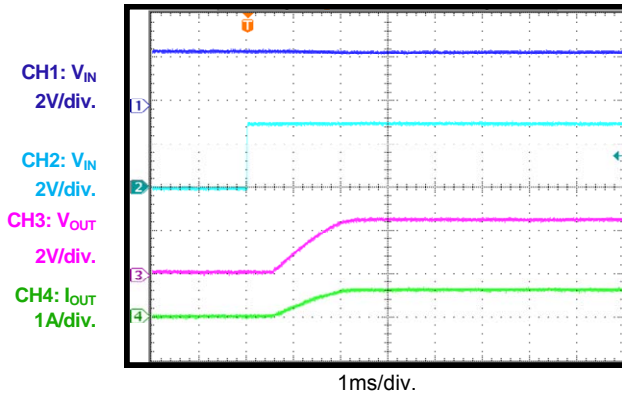

Enable Off

$V_{IN}=2.5\text{V}$, $V_{OUT}=1.2\text{V}$, $I_{OUT}=0.6\text{A}$

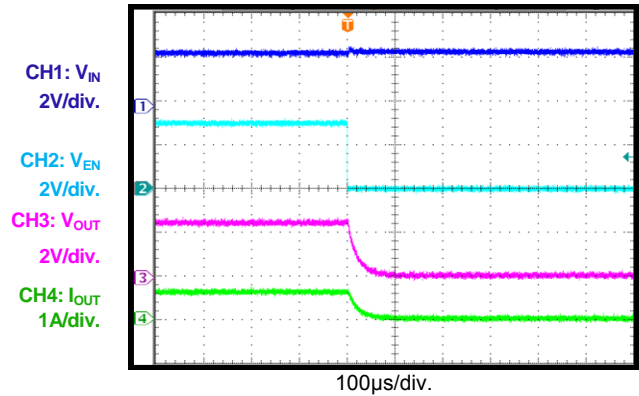

EVB TEST RESULTS (continued)

$T_A = 25^\circ\text{C}$, unless otherwise noted.

Enable On

$V_{IN}=3.3\text{V}$, $V_{OUT}=1.8\text{V}$, $I_{OUT}=0.6\text{A}$

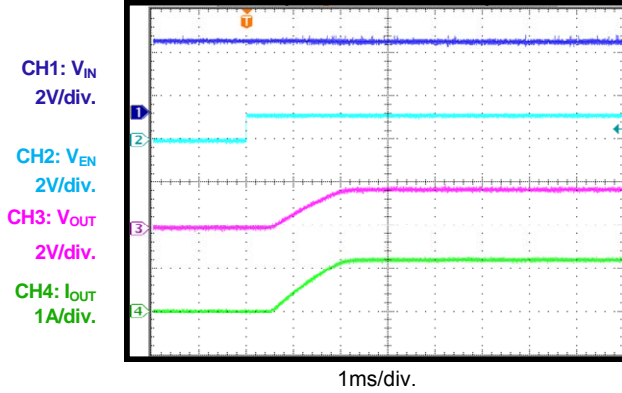

Enable Off

$V_{IN}=3.3\text{V}$, $V_{OUT}=1.8\text{V}$, $I_{OUT}=0.6\text{A}$

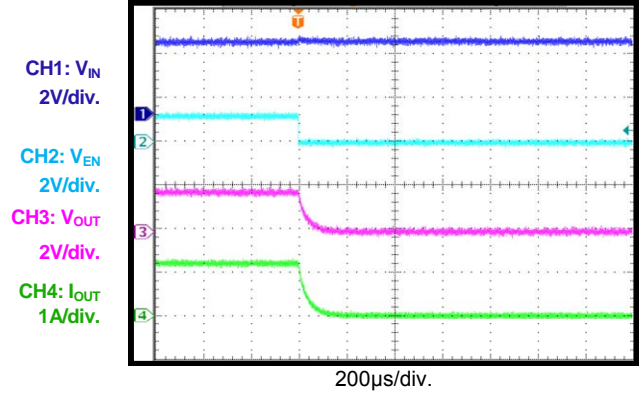

Steady State

$V_{IN}=5\text{V}$, $V_{OUT}=1.8\text{V}$, $I_{OUT}=0.6\text{A}$

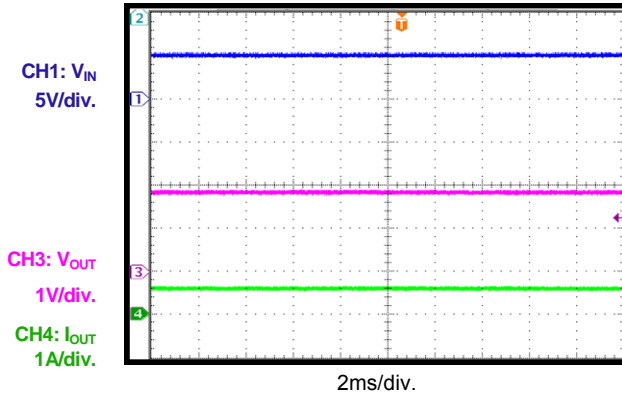

Steady State

$V_{IN}=5\text{V}$, $V_{OUT}=1.2\text{V}$, $I_{OUT}=0.6\text{A}$

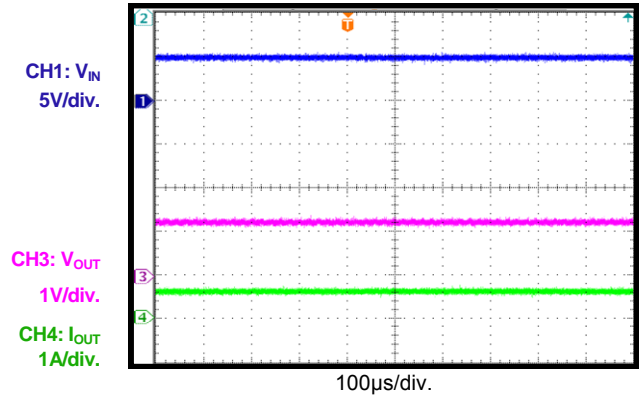

Short Circuit

$V_{IN}=5\text{V}$, $V_{OUT}=1.2\text{V}$

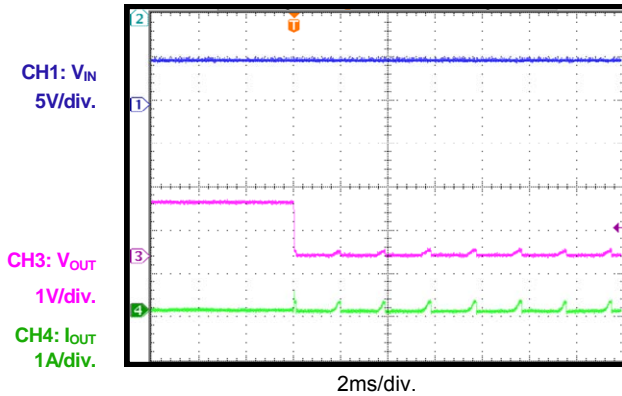

Short Circuit Recovery

$V_{IN}=5\text{V}$, $V_{OUT}=1.2\text{V}$

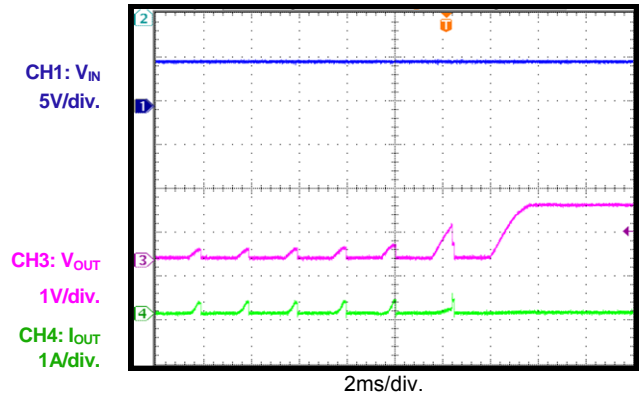

EVB TEST RESULTS (continued)

$T_A = 25^\circ\text{C}$, unless otherwise noted.

Short Circuit Entry

$V_{IN}=5\text{V}$, $V_{OUT}=1.8\text{V}$

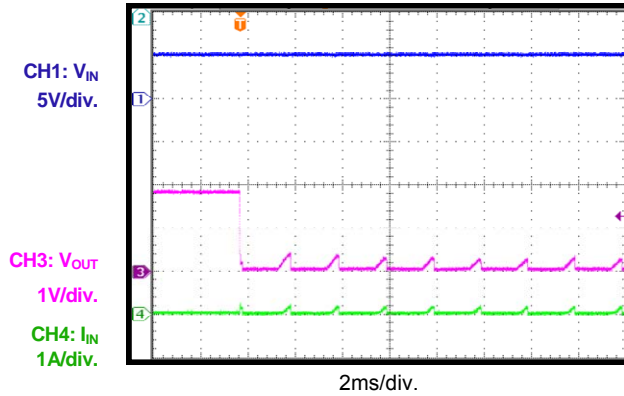

Short Circuit

$V_{IN}=5\text{V}$, $V_{OUT}=1.8\text{V}$

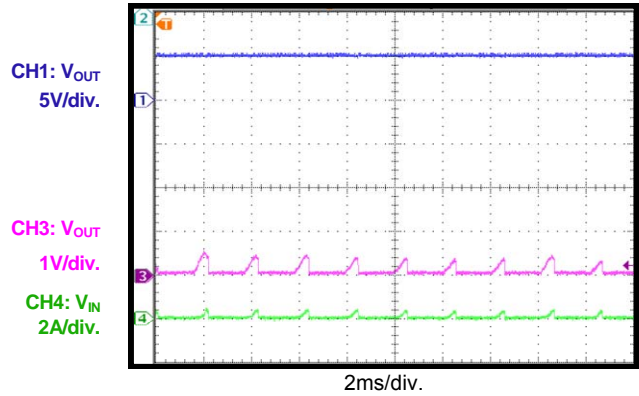

Short Circuit Recovery

$V_{IN}=5\text{V}$, $V_{OUT}=1.2\text{V}$

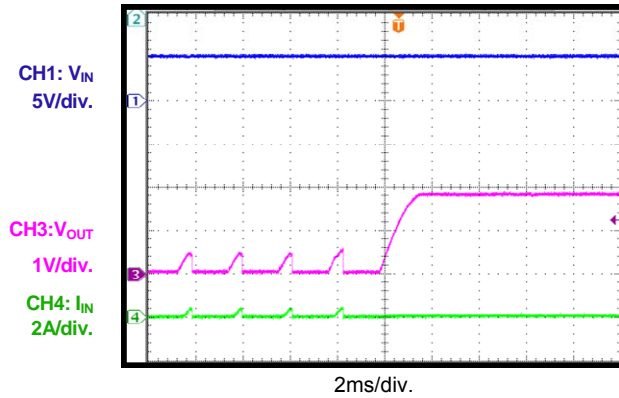

Transient Response

$V_{IN}=2.5\text{V}$, $V_{OUT}=1.2\text{V}$, $I_{OUT}=0\text{A}-0.6\text{A}$, $0.25\text{A}/\mu\text{s}$

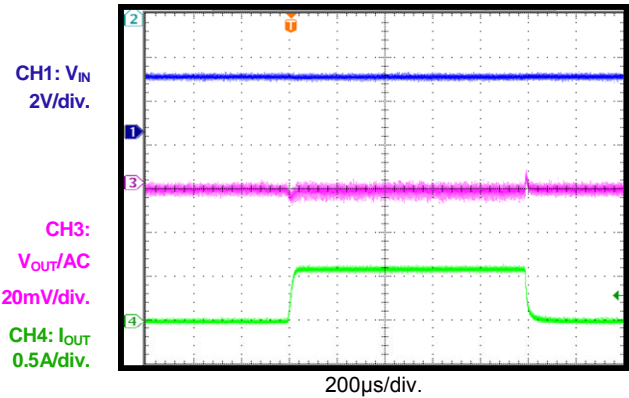

Transient Response

$V_{IN}=3.3\text{V}$, $V_{OUT}=1.2\text{V}$, $I_{OUT}=0\text{A}-0.6\text{A}$, $0.25\text{A}/\mu\text{s}$

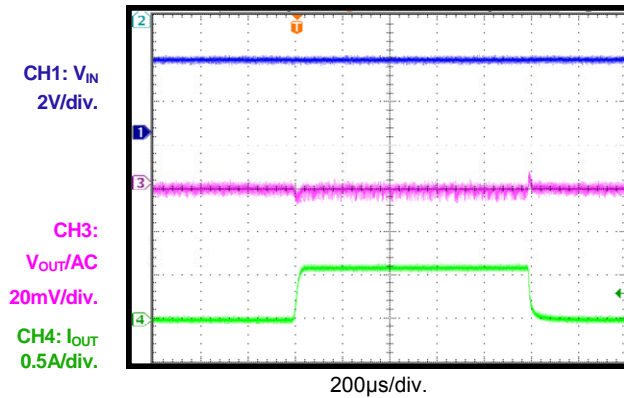

Transient Response

$V_{IN}=6\text{V}$, $V_{OUT}=1.2\text{V}$, $I_{OUT}=0\text{A}-0.6\text{A}$, $0.25\text{A}/\mu\text{s}$

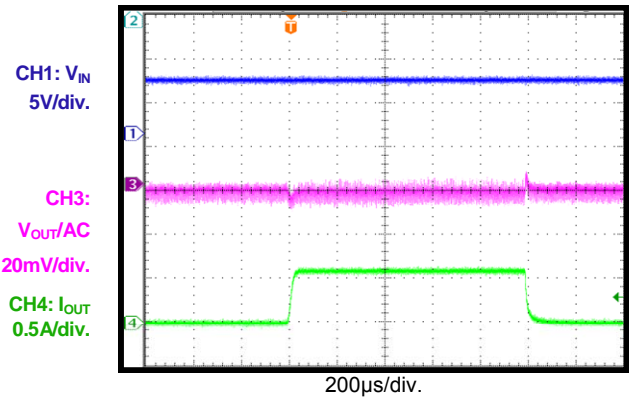

EVB TEST RESULTS (continued)

$T_A = 25^\circ\text{C}$, unless otherwise noted.

Transient Response

$V_{IN}=2.5\text{V}$, $V_{OUT}=1.8\text{V}$, $I_{OUT}=0\text{A}-0.6\text{A}$, $0.25\text{A}/\mu\text{s}$

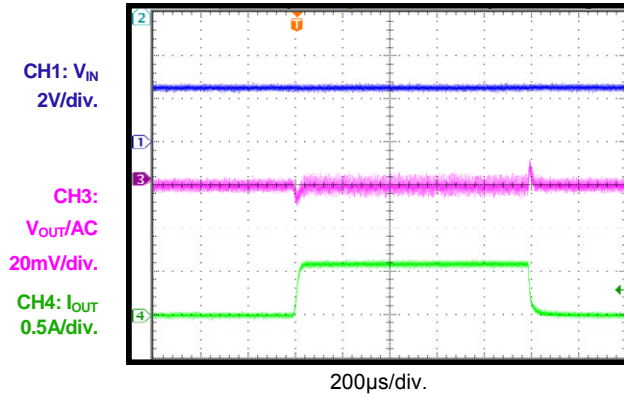

Transient Response

$V_{IN}=3.3\text{V}$, $V_{OUT}=1.8\text{V}$, $I_{OUT}=0\text{A}-0.6\text{A}$, $0.25\text{A}/\mu\text{s}$

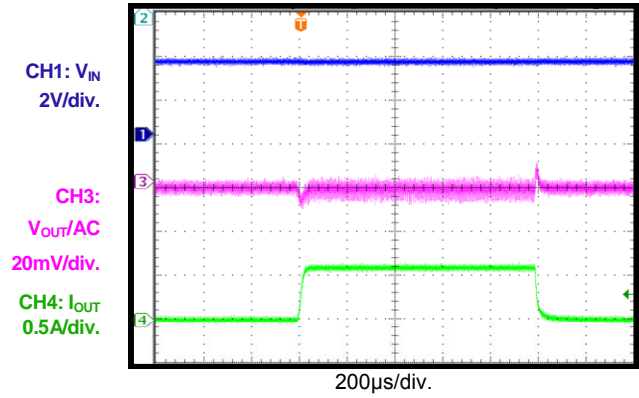

Transient Response

$V_{IN}=6\text{V}$, $V_{OUT}=1.8\text{V}$, $I_{OUT}=0\text{A}-0.6\text{A}$, $0.25\text{A}/\mu\text{s}$

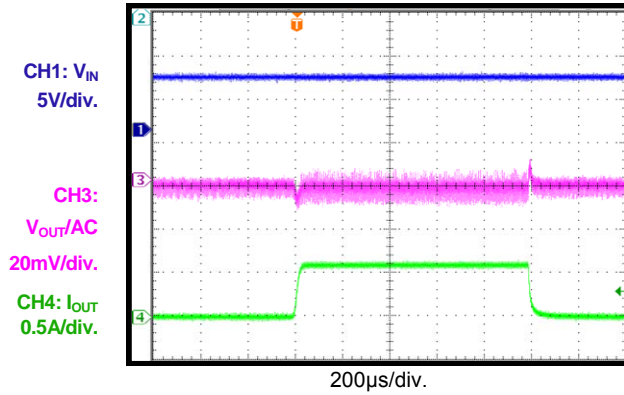

PRINTED CIRCUIT BOARD LAYER

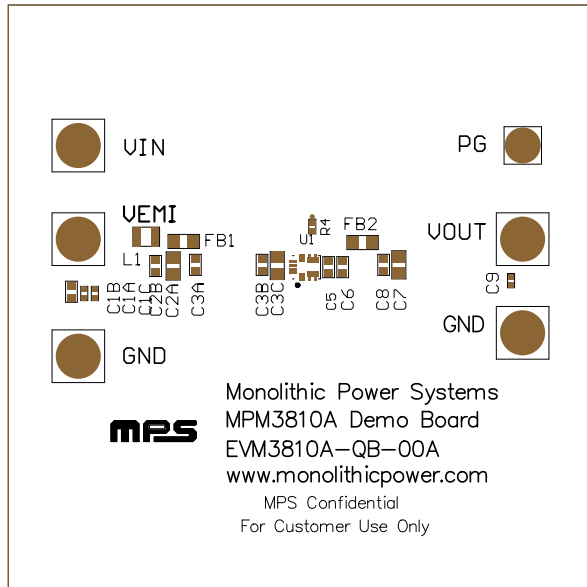

Figure 1: Top Silk Layer

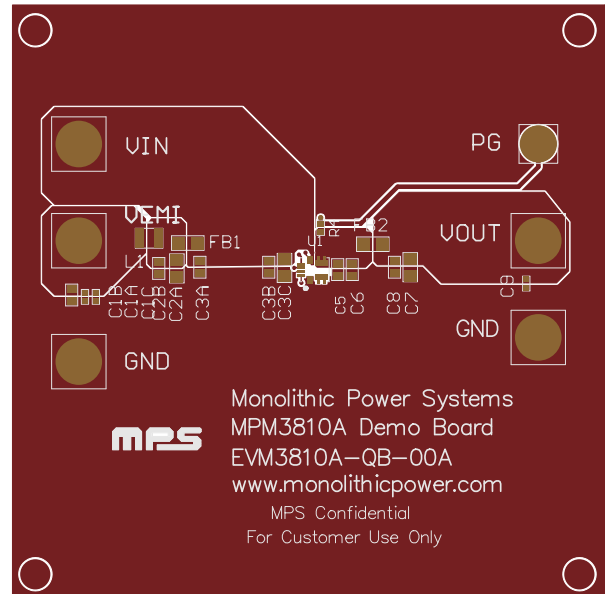

Figure 2: Top Layer

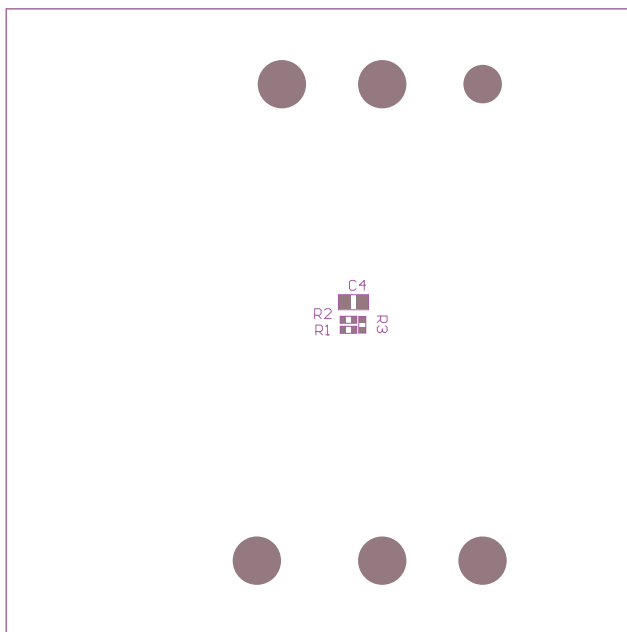

Figure 3: Bottom Silk Layer

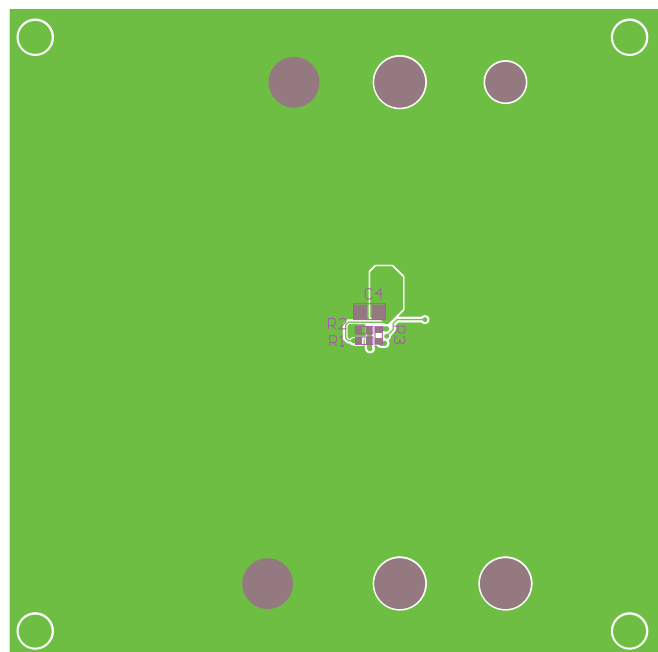

Figure 4: Bottom Layer