



EVQ2179-LE-00A

5.5V, 3A, 2.4MHz, Synchronous Step-Down Converter with PG and SS, AEC-Q100 Qualified Evaluation Board

DESCRIPTION

The EVQ2179-LE-00A is an evaluation board designed to demonstrate the capabilities of the MPQ2179, a monolithic, step-down switch-mode converter with built-in internal power MOSFETs.

The EVQ2179-LE-00A achieves 3A of output current from a 2.5V to 5.5V input voltage range, with excellent load and line regulation. The output voltage (V_{OUT}) can be regulated to as low as 0.6V.

Fault protections include cycle-by-cycle current limiting and thermal shutdown.

The EVQ2179-LE-00A is a fully assembled and tested evaluation board. It generates a 1.2V V_{OUT} at load currents up to 3A from a 2.5V to 5.5V input range.

The MPQ2179 is available in a compact QFN-8 (1.5mmx2mm) package, and is AEC-Q100 qualified.

ELECTRICAL SPECIFICATIONS

Parameter	Symbol	Value	Units
Input voltage	V_{IN}	2.5 to 5.5	V
Output voltage	V_{OUT}	1.2	V
Output current	I_{OUT}	3	A

FEATURES

Designed for Automotive Applications

- Wide 2.5V to 5.5V Operating Input Range
- Up to 3A Output Current
- 1% FB Accuracy

High Performance for Improved Thermals

- 65m Ω and 35m Ω Internal Power MOSFET Switches

Optimized for EMC/EMI

- 2.4MHz Switching Frequency
- Forced Continuous Conduction Mode (CCM) across the Full Load Range

Additional Features

- Power Good (PG)
- External Soft Start (SS) Control
- Output Discharge
- Output Over-Voltage Protection (V_{OUT} OVP)
- Short-Circuit Protection (SCP) with Hiccup Mode

Optimized for Board Size and BOM

- Integrated Compensation Network
- Available in a Compact QFN-8 (1.5mmx2mm) Package
- Available in AEC-Q100 Grade 1

APPLICATIONS

- Automotive Infotainment
- Camera Modules
- Key Fobs
- Automotive Clusters
- Automotive Telematics
- Industrial Supplies
- Battery-Powered Devices

All MPS parts are lead-free, halogen-free, and adhere to the RoHS directive. For MPS green status, please visit the MPS website under Quality Assurance. "MPS", the MPS logo, and "Simple, Easy Solutions" are trademarks of Monolithic Power Systems, Inc. or its subsidiaries.

EVQ2179-LE-00A EVALUATION BOARD

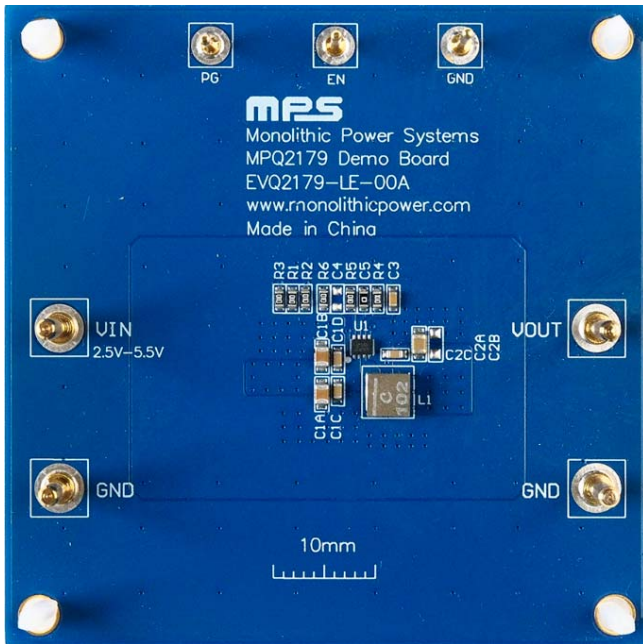

(LxWxH) 6.3cmx6.3cmx0.3cm

Board Number	MPS IC Number
EVQ2179-LE-00A	MPQ2179GQHE-AEC1

Efficiency vs. Load Current vs. Power Loss

$V_{OUT} = 1.2V$, $L = 1\mu H$
(XEL4020-102MEB, DCR = 13.25m Ω)

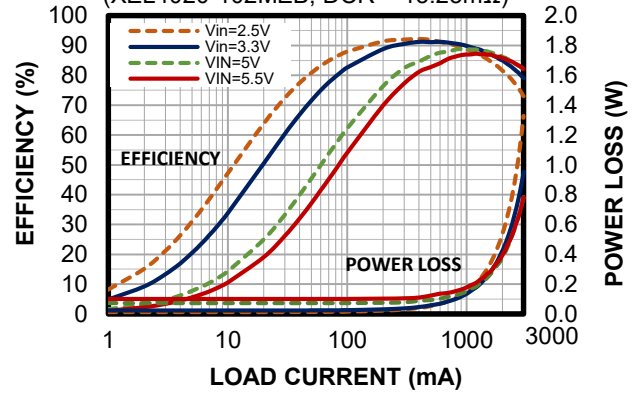

QUICK START GUIDE

1. Preset the power supply to $2.5V \leq V_{IN} \leq 5.5V$.
2. Connect the power supply terminals to:
 - a. Positive (+): VIN
 - b. Negative (-): GND
3. Connect the load terminals to:
 - a. Positive (+): VOUT
 - b. Negative (-): GND
4. After making connections, turn on the power supply.
5. To use the enable function, apply a digital input to the EN pin. Drive EN above 0.9V to turn the regulator on; drive EN below 0.65V to turn it off.
6. The external resistor divider sets the output voltage (V_{OUT}). To adjust the MPQ2179's output, set feedback resistor R5 to be between 10k Ω and 100k Ω . R6 can then be calculated with Equation (1):

$$R6 = \frac{R5}{\frac{V_{OUT}}{0.6} - 1} \quad (1)$$

Table 1 lists the recommended resistor values for common output voltages.

Table 1: Resistor Values for Common Output Voltages

V_{OUT} (V)	R1 (kΩ)	R2 (kΩ)
1.0	30.9 (1%)	47 (1%)
1.2	100 (1%)	100 (1%)
1.8	36 (1%)	18 (1%)
2.5	51 (1%)	16 (1%)
3.3	68 (1%)	15 (1%)

EVALUATION BOARD SCHEMATIC

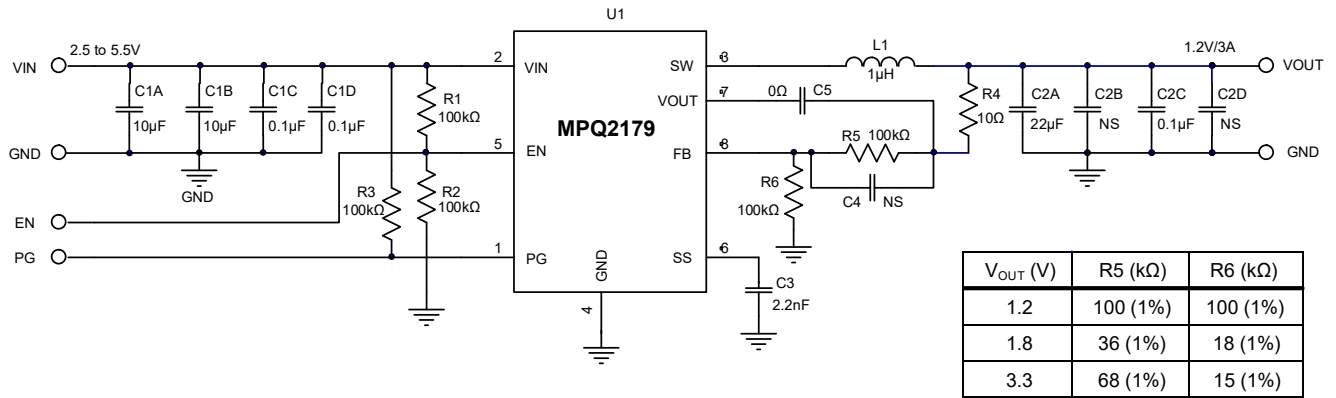

Figure 1: Evaluation Board Schematic

EVQ2179-LE-00A BILL OF MATERIALS

Qty	Designator	Value	Description	Package	Manufacturer	Manufacturer PN
1	CIN1	22 μ F	Electrical capacitor, 63V	SMD	Jianghai	VTD-63V22
2	C1A, C1B	4.7 μ F	Ceramic capacitor, 16V, X7R	0805	Murata	GCM21BR71C475KA73L
3	C1C, C1D, C2C	0.1 μ F	Ceramic capacitor, 16V, X7R	0603	TDK	C1608X7R1C104K
1	C2A	22 μ F	Ceramic capacitor, 6.3V, X5R	0805	Murata	GRM21BR60J226ME39L
1	C5	0 Ω	Film resistor, 1%	0603	Yageo	RC0603FR-070RL
0	C4	NS				
1	C3	2.2nF	Ceramic capacitor, 50V, X7R	0603	TDK	C1608X7R1H222K
5	R1, R2, R3, R5, R6	100k Ω	Film resistor, 1%	0603	Yageo	RC0603FR-07100KL
1	R4	10 Ω	Film resistor, 1%	0603	Yageo	RC0603FR-0710RL
1	L1	1 μ H	Inductor, 14.6m Ω , 9.6A	SMD	Coilcraft	XEL4020-102MEB
4	VIN, GND, VOUT, GND	Test point	2.0 golden pin	DIP	Custom	
3	EN, PG, GND	Test point	1.0 golden pin	DIP	Custom	
1	U1	MPQ2179-AEC1	5.5V, 3A, step-down converter, AEC-Q100 qualified	QFN-8 (1.5mmx2mm)	MPS	MPQ2179GQHE-AEC1

EVB TEST RESULTS

Performance curves and waveforms are tested on the evaluation board. $V_{IN} = 3.6V$, $V_{OUT} = 1.2V$, $L = 1\mu H$, $C_{OUT} = 22\mu F$, $T_A = 25^\circ C$, unless otherwise noted.

Efficiency vs. Load Current vs. Power Loss (Light Loads)

$V_{OUT} = 1.2V$, $L = 1\mu H$
(XEL4020-102MEB, DCR = 13.25m Ω)

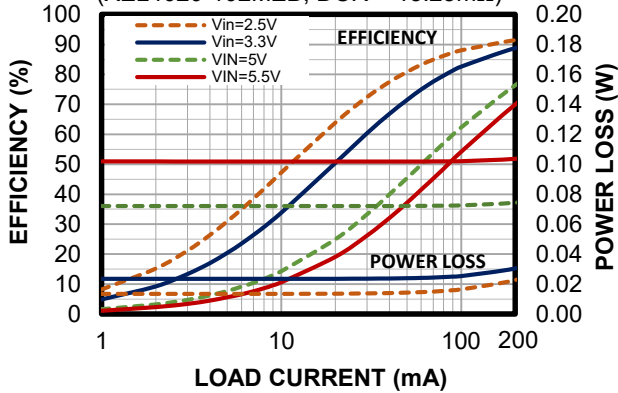

Efficiency vs. Load Current vs. Power Loss

$V_{OUT} = 1.2V$, $L = 1\mu H$
(XEL4020-102MEB, DCR = 13.25m Ω)

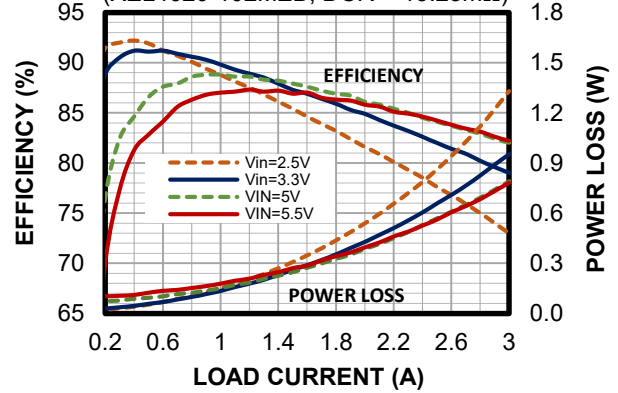

Efficiency vs. Load Current vs. Power Loss (Light Loads)

$V_{OUT} = 1.8V$, $L = 1\mu H$
(XEL4020-102MEB, DCR = 13.25m Ω)

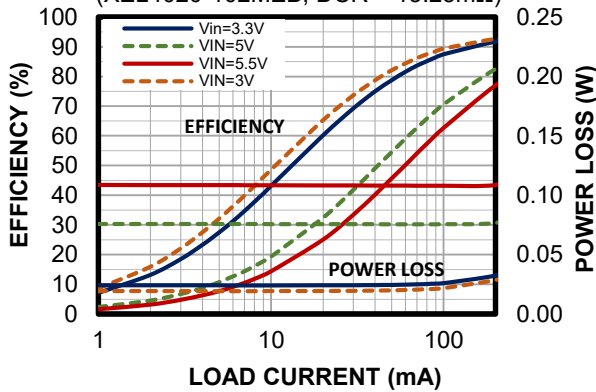

Efficiency vs. Load Current vs. Power Loss

$V_{OUT} = 1.8V$, $L = 1\mu H$
(XEL4020-102MEB, DCR = 13.25m Ω)

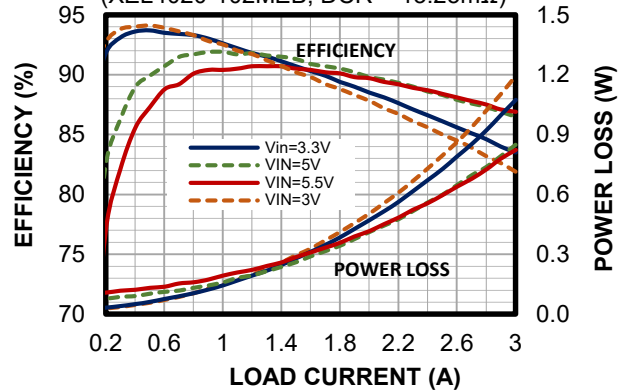

Case Temperature Rise

$V_{OUT} = 1.2V$

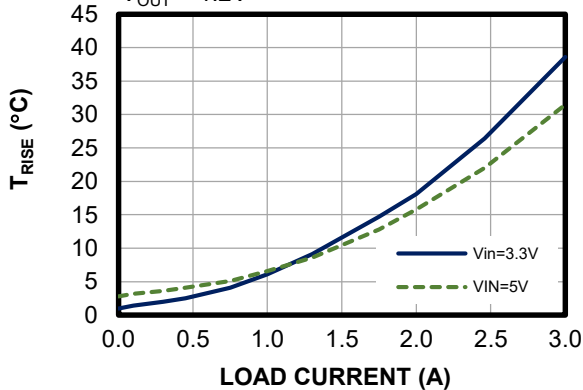

Case Temperature Rise

$V_{OUT} = 1.8V$

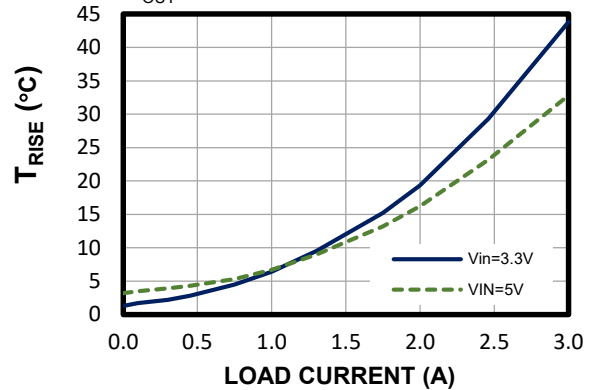

EVB TEST RESULTS *(continued)*

Performance curves and waveforms are tested on the evaluation board. $V_{IN} = 3.6V$, $V_{OUT} = 1.2V$, $L = 1\mu H$, $C_{OUT} = 22\mu F$, $T_A = 25^\circ C$, unless otherwise noted.

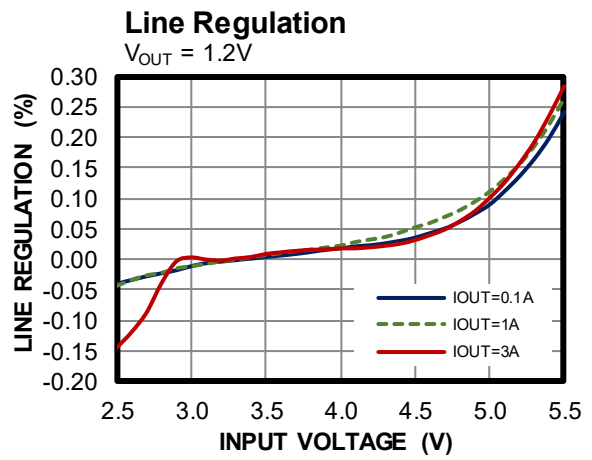
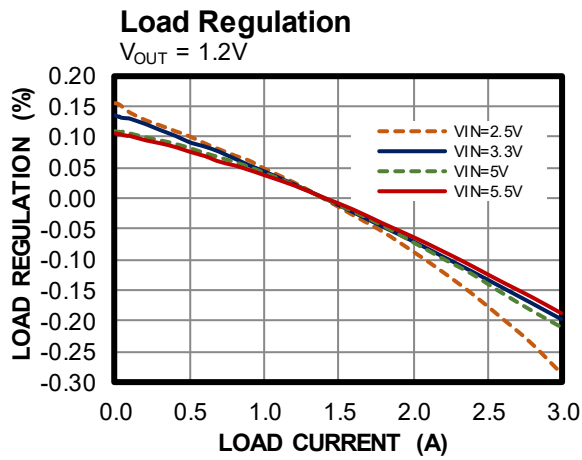

EVB TEST RESULTS (continued)

Performance curves and waveforms are tested on the evaluation board. $V_{IN} = 3.6V$, $V_{OUT} = 1.2V$, $L = 1\mu H$, $C_{OUT} = 22\mu F$, $T_A = 25^\circ C$, unless otherwise noted.

Steady State

$I_{OUT} = 0A$

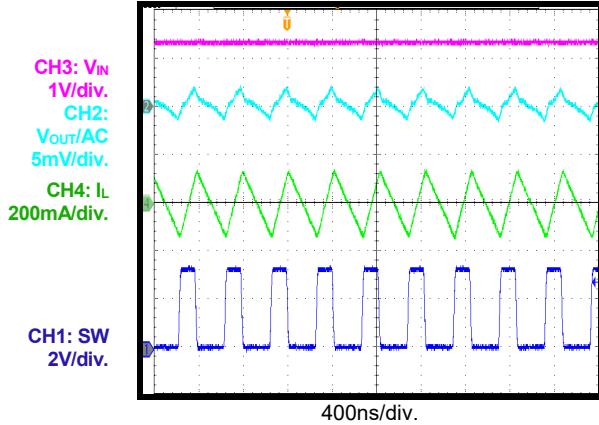

Steady State

$I_{OUT} = 3A$

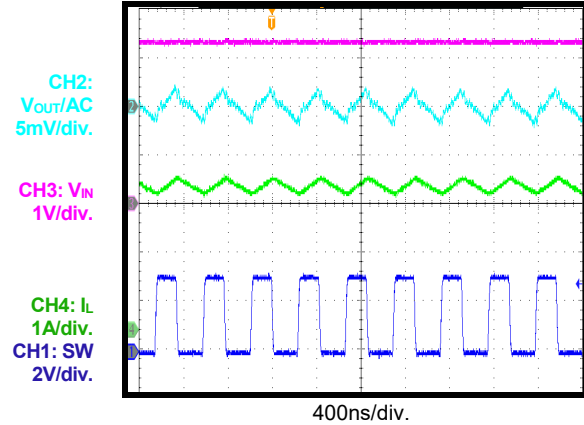

Start-Up through VIN

$I_{OUT} = 0A$

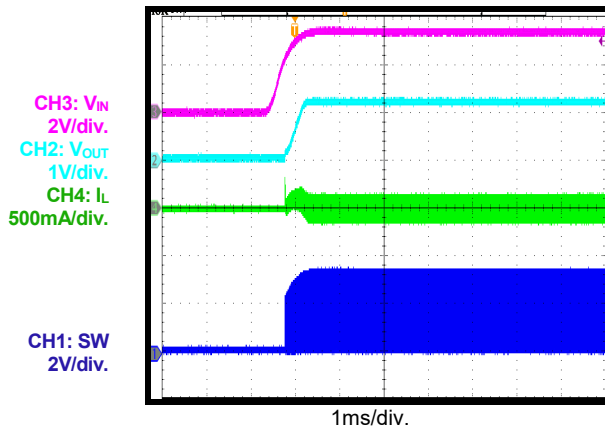

Start-Up through VIN

$I_{OUT} = 3A$

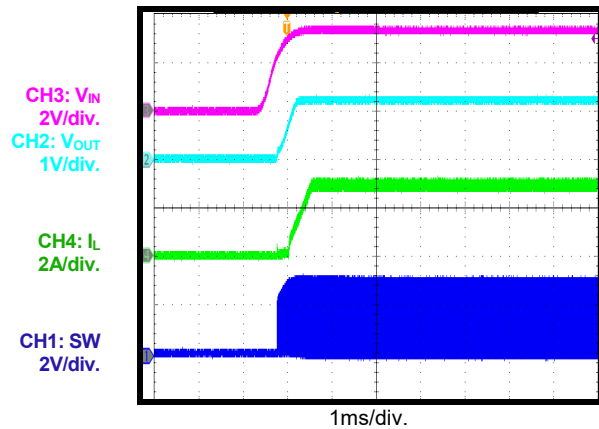

Shutdown through VIN

$I_{OUT} = 0A$

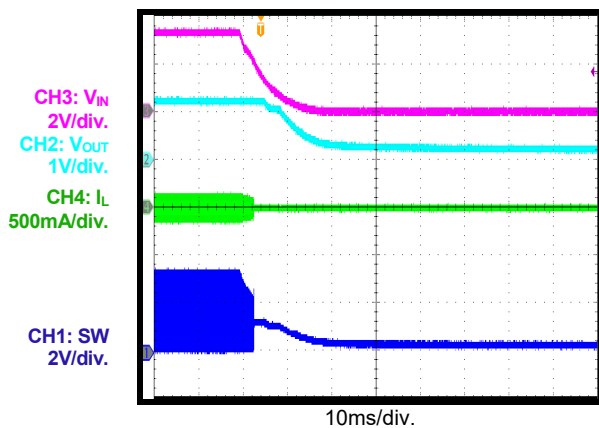

Shutdown through VIN

$I_{OUT} = 3A$

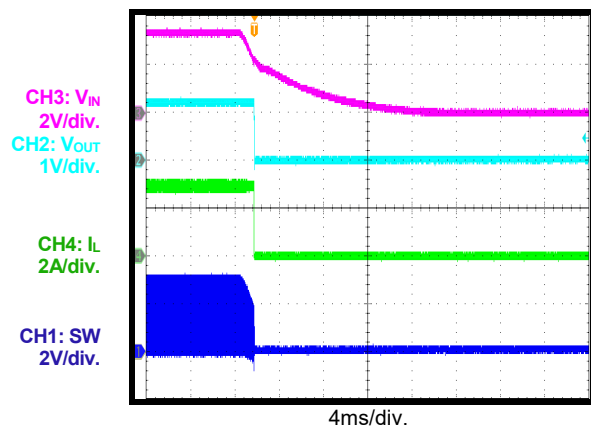

EVB TEST RESULTS (continued)

Performance curves and waveforms are tested on the evaluation board. $V_{IN} = 3.6V$, $V_{OUT} = 1.2V$, $L = 1\mu H$, $C_{OUT} = 22\mu F$, $T_A = 25^\circ C$, unless otherwise noted.

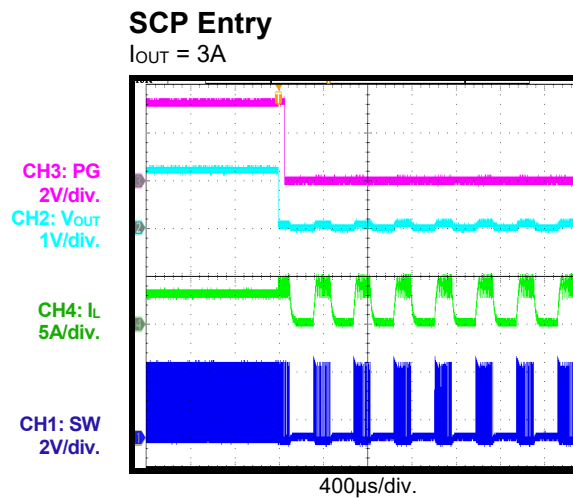
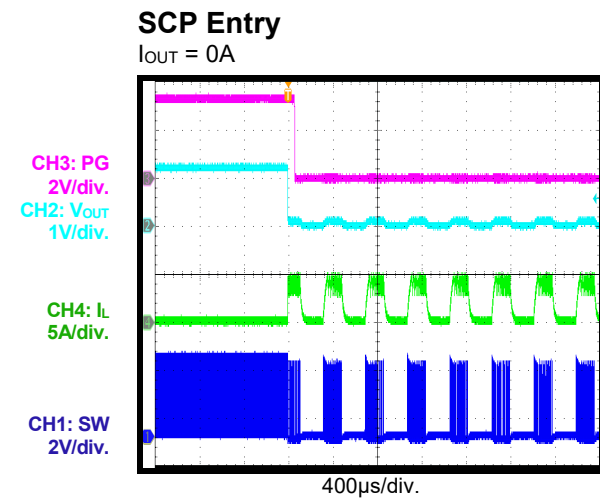
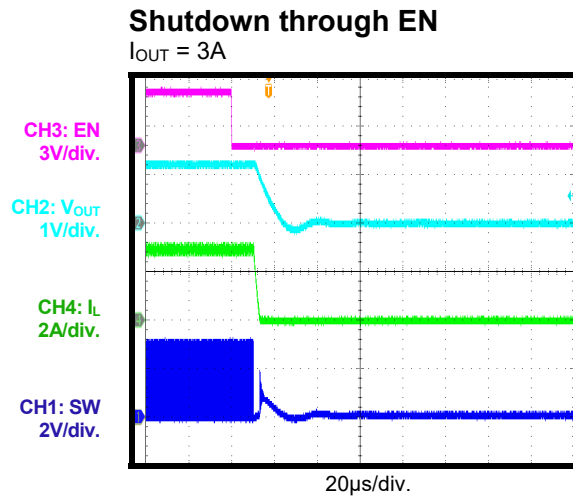
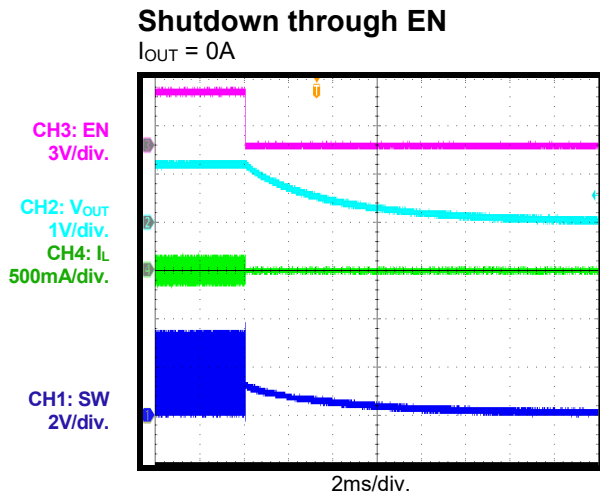
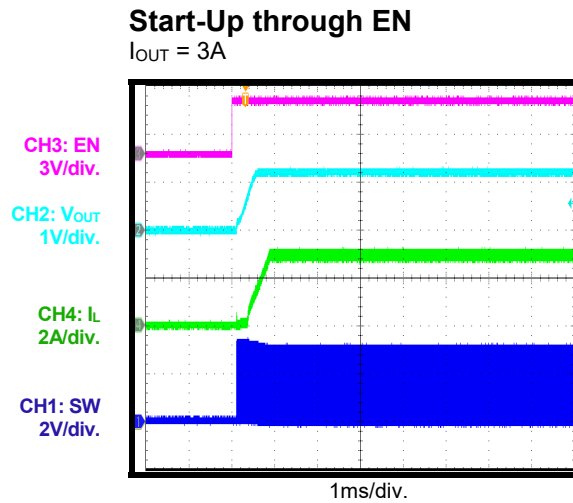
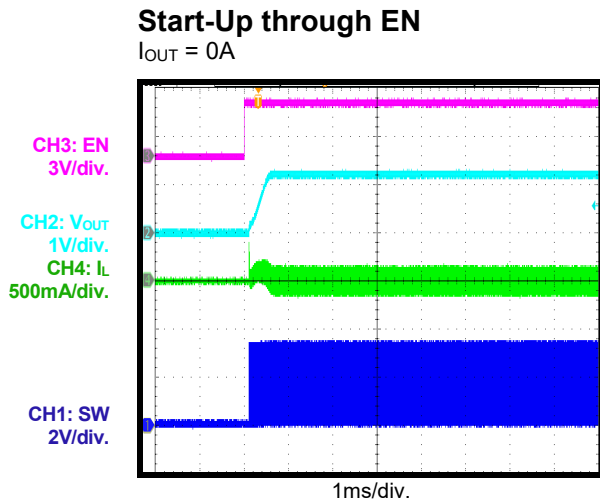

EVB TEST RESULTS (continued)

Performance curves and waveforms are tested on the evaluation board. $V_{IN} = 3.6V$, $V_{OUT} = 1.2V$, $L = 1\mu H$, $C_{OUT} = 22\mu F$, $T_A = 25^\circ C$, unless otherwise noted.

SCP Recovery

$I_{OUT} = 0A$

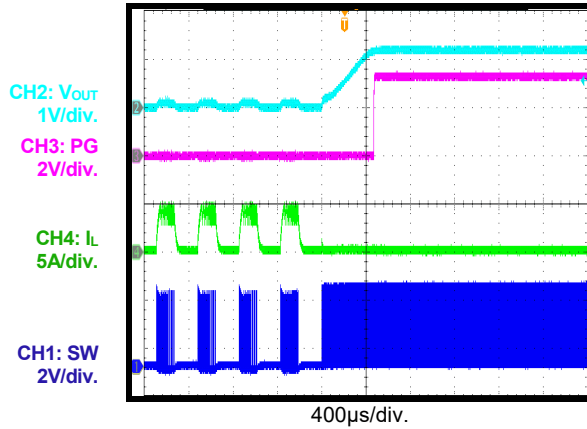

SCP Recovery

$I_{OUT} = 3A$

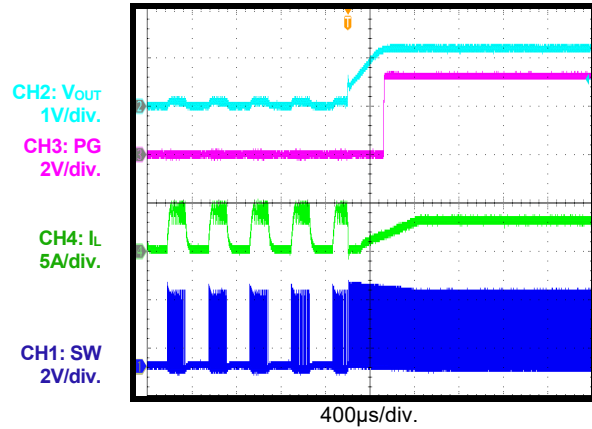

Short Circuit

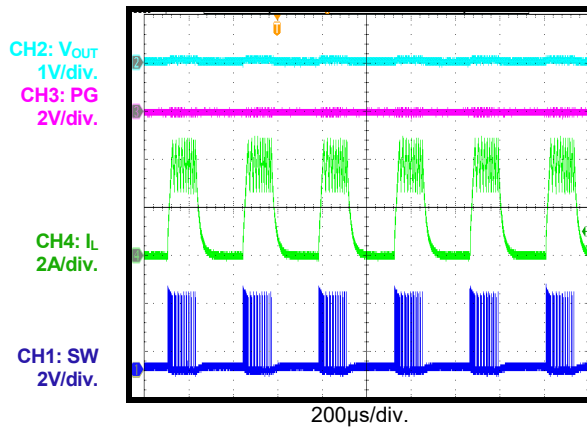

PG Start-Up through VIN

$I_{OUT} = 3A$

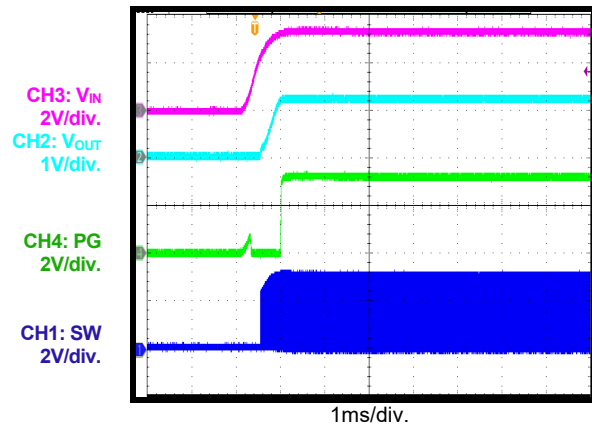

PG Shutdown through VIN

$I_{OUT} = 3A$

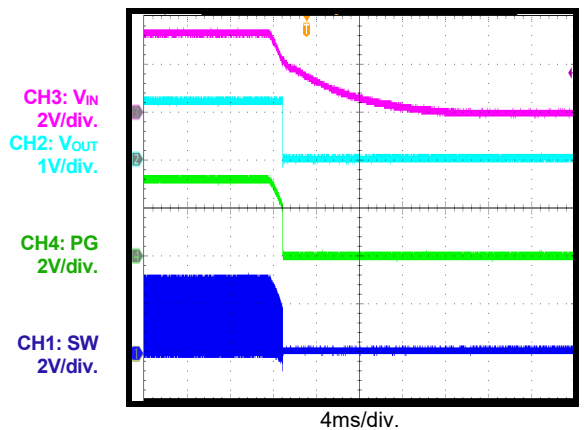

PG Start-Up through EN

$I_{OUT} = 3A$

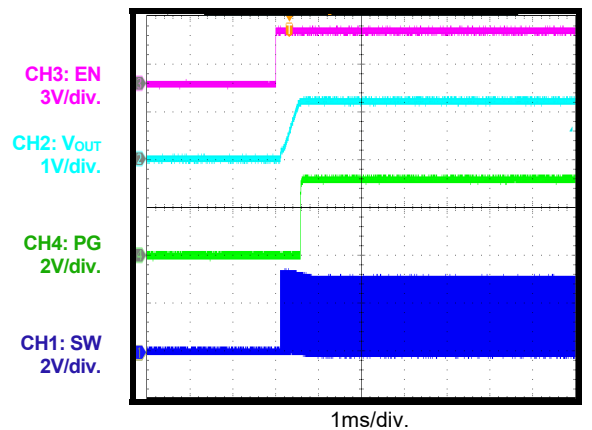

EVB TEST RESULTS *(continued)*

Performance curves and waveforms are tested on the evaluation board. $V_{IN} = 3.6V$, $V_{OUT} = 1.2V$, $L = 1\mu H$, $C_{OUT} = 22\mu F$, $T_A = 25^\circ C$, unless otherwise noted.

PG Shutdown through EN

$I_{OUT} = 3A$

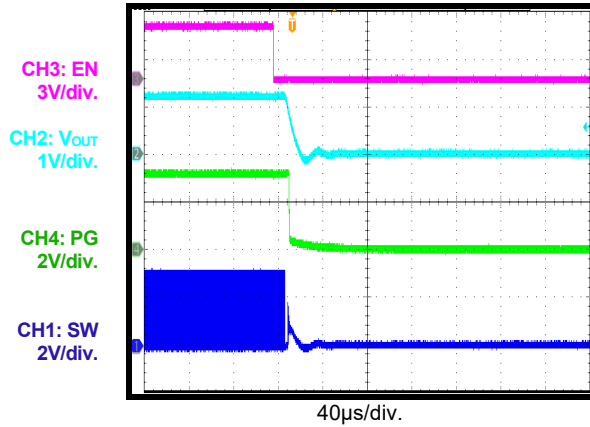

Load Transient

$I_{OUT} = 1.5A$ to $3A$, $1A/\mu s$

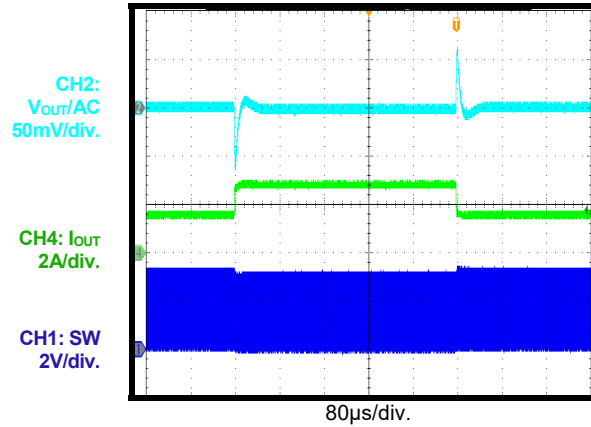

PCB LAYOUT

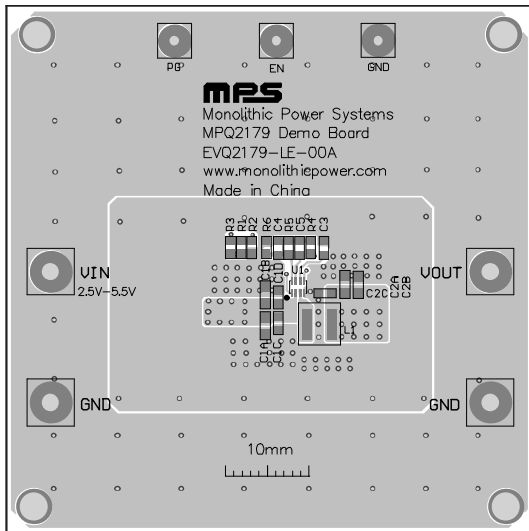

Figure 2: Top Silk and Top Layer

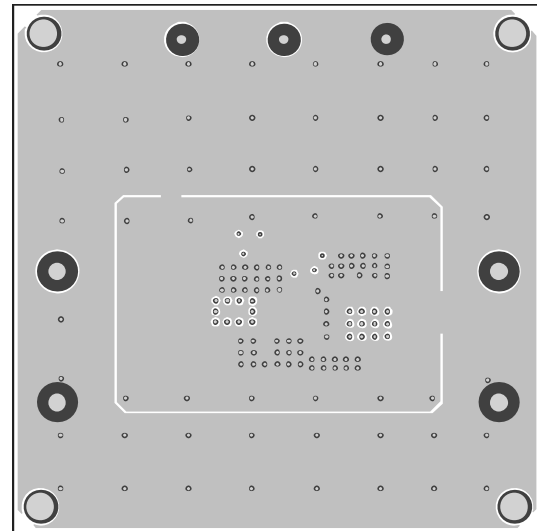

Figure 3: Mid-Layer 1

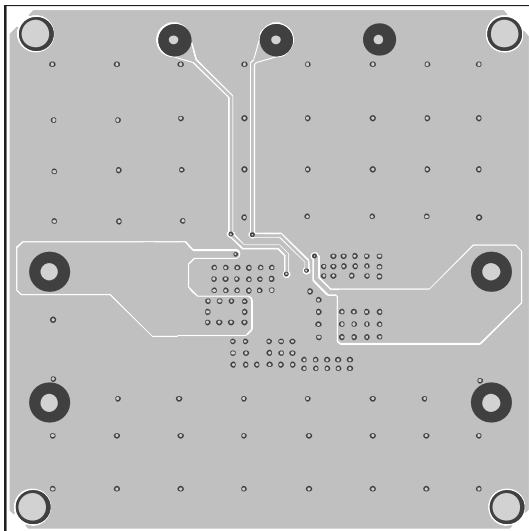

Figure 4: Mid-Layer 1

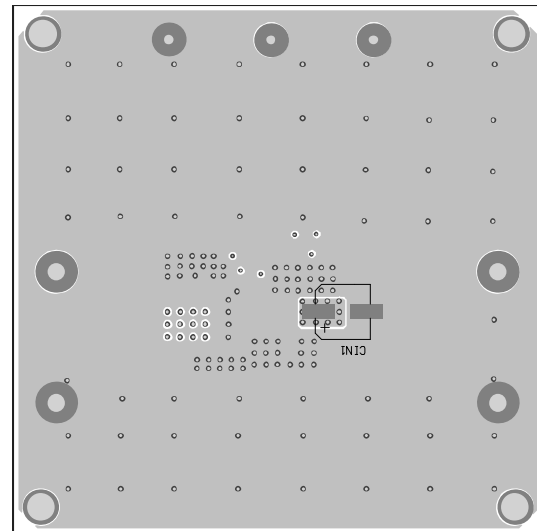

Figure 5: Bottom Layer and Bottom Silk