

DESCRIPTION

The MPQ2483 is a 55V, white LED driver suitable for either step-down or inverting step-up/down applications. It achieves 2.5A peak current over a wide input supply range with excellent load and line regulation. Current mode operation provides fast transient response and eases loop stabilization. Fault condition protection includes thermal shutdown, cycle-by-cycle peak current limiting, input over voltage protection, open strings protection and output short circuit protection.

The MPQ2483 incorporates both DC and PWM dimming onto a single control pin. The separate input reference ground pin allows for direct enable and/or dimming control for a positive to negative power conversion.

The MPQ2483 is package in SO-14.

MPQ2483-S DEMO BOARDS

Board number	Operating Mode	Input (V)	LED#	I _{LED} (mA)
EVQ2483-S-00A	Buck-boost	12	1-4	700

FEATURES

- Unique Step-up/down Operation (Buck-Boost Mode)
- Wide 4.5V to 55V Operating Input Range for Step-Down Applications (Buck Mode)
- 0.28Ω Internal Power MOSFET Switch
- Adjustable Switching Frequency
- Analog and PWM Dimming
- 0.198V Reference Voltage
- 5μA Shutdown Mode
- No minimum LED required
- Stable with Low ESR Output Ceramic Capacitors
- Cycle-by-Cycle Over Current Protection
- Thermal Shutdown Protection
- Open Strings Protection
- Output Short Circuit Protection
- Available in 14-Pin SO14 Package

APPLICATIONS

- General LED Illuminations
- LCD Backlight Panels
- Automotive Lighting

All MPS parts are lead-free, halogen free, and adhere to the RoHS directive. For MPS green status, please visit MPS website under Quality Assurance. "MPS" and "The Future of Analog IC Technology" are Registered Trademarks of Monolithic Power Systems, Inc.

EVQ2483-S-00A EVALUATION BOARD



(L x W x H) 5cm x 4.5cm x 0.7cm

Board Number	MPS IC Number
EVQ2483-S-00A	MPQ2483DS

EVALUATION BOARD SCHEMATIC

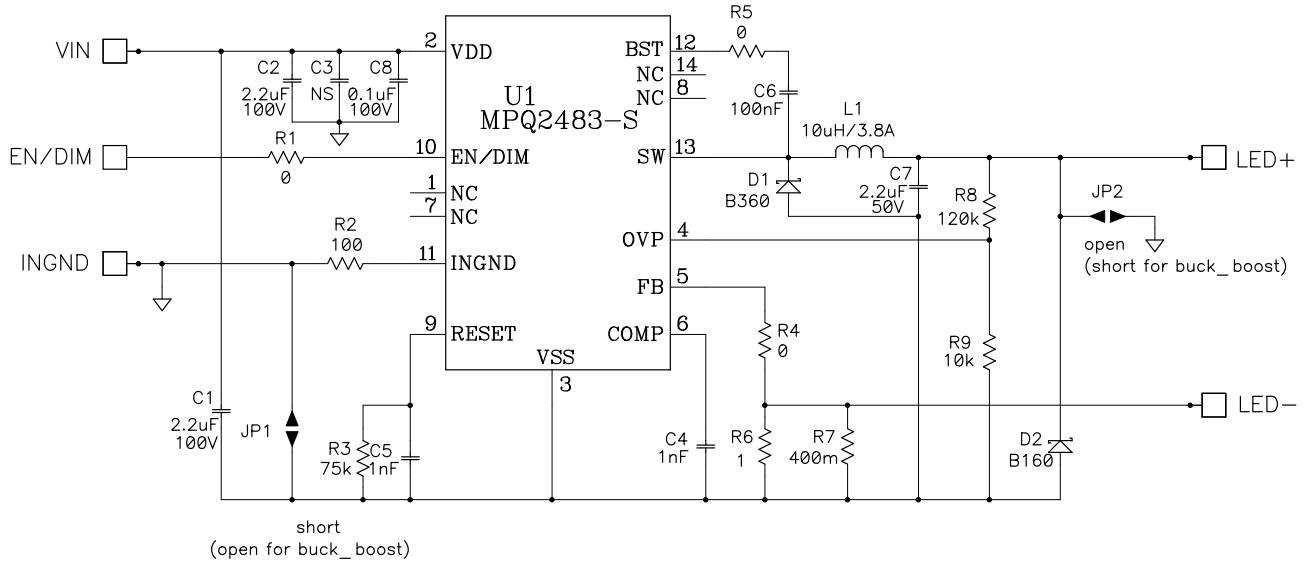

EVQ2483-S-00A BILL OF MATERIALS

Qty	Ref	Value	Description	Package	Manufacturer	Part Number
3	C1, C2, C7	2.2µF	Ceramic Cap., 100V, 10%, X7R	1210	muRata	GRM32ER72A225KA35L
1	C3	NS				
2	C4, C5	1nF	Ceramic Cap., 50V, 10%, X7R	0603	muRata	GRM188R71H102KA01D
1	C6	0.1µF	Ceramic Cap., 25V, 10%, X7R	0603	muRata	GRM188R71E104KA01D
1	C8	0.1µF	Ceramic Cap., 100V, 10%, X7R	0805	muRata	GRM188R72A104KA35D
1	D1	B360	Schottky Rect., 60V,3A	SMA	Diodes Inc	GCM21BR72A104KA37L
1	D2	B160	Schottky Rect., 60V,1A	SMA	Diodes Inc	B160-13-F
1	L1	10µH	Inductor, Rdc 28mΩ, Isat 4A	SMD	Wurth Elektronik	744066100
3	R1, R4, R5	0	Film Res., 5%	0603	Yageo	RC0603JR-070RL
1	R2	100	Film Res., 5%	0603	Yageo	RC0603JR-07100RL
1	R3	75kΩ	Film Res., 1%	0603	Yageo	RC0603FR-0775KL
1	R6	1Ω	Film Res.1%	0805	ROYALOHM	RC0805FR-071RL
1	R7	400mΩ	Film Res. 1%	0805	ROYALOHM	0808F400LT5E
1	R8	120kΩ	Film Res., 1%	0603	Yageo	RC0603FR-07120KL
1	R9	10k	Film Res., 1%	0603	Yageo	RC0603FR-0710KL
1	U1	MPQ2483	Power Led Driver	SO-14	MPS	MPQ2483DS
1	EN/DIM, LED+, LED-, VIN,GND		11 Pin Header, 2.54mm	2.54mm	Sullins	PCC11SAAN
	JP1, JP2		NS			

EVB TEST RESULTS

Buck Boost Mode, $L = 10\mu\text{H}$, $F_{\text{SW}} = 330\text{kHz}$, 3LED, $I_{\text{OUT}} = 0.7\text{A}$, $T_A = 25^\circ\text{C}$, unless otherwise noted.

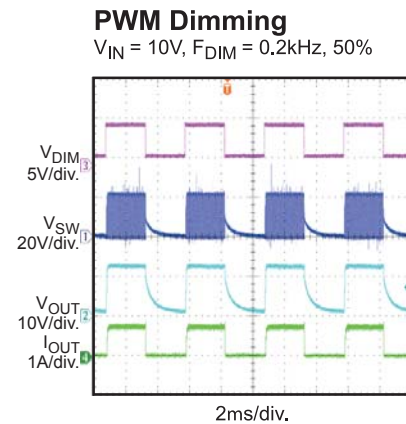
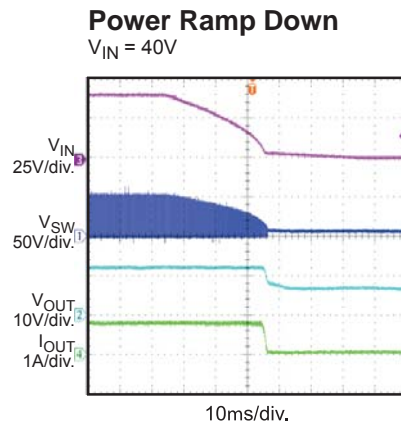
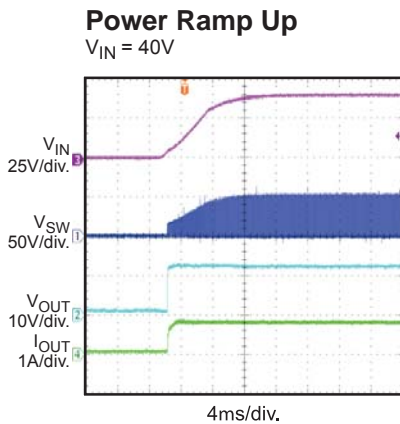
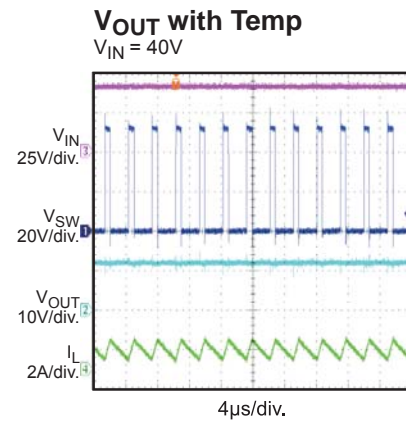
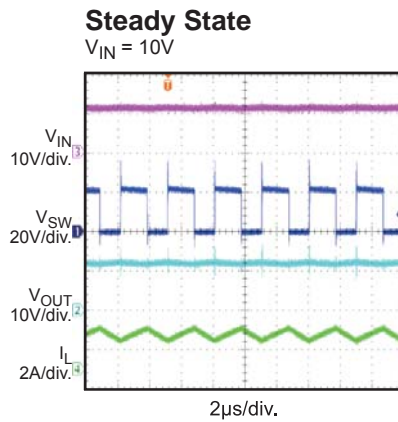
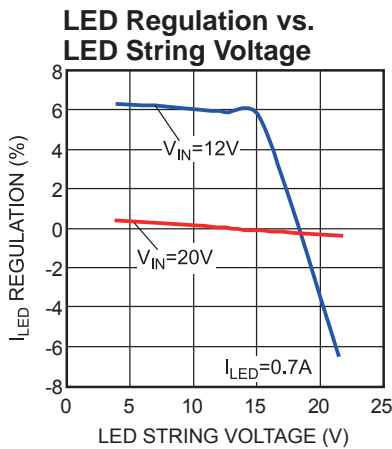
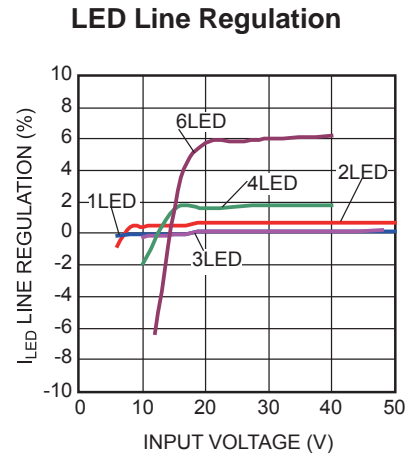
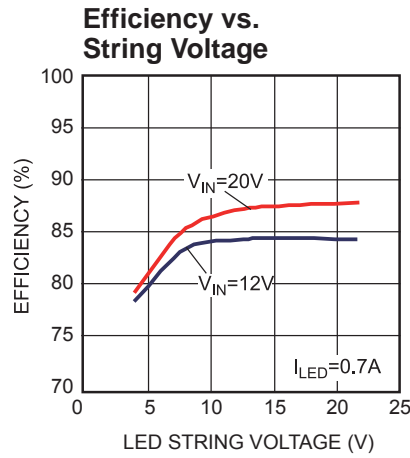
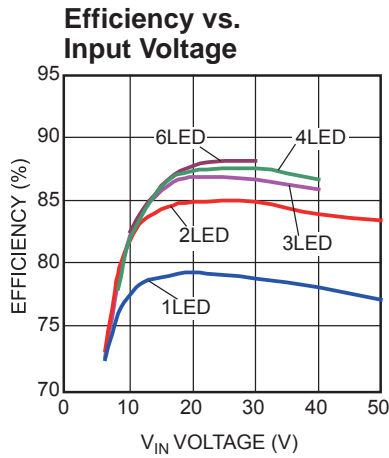

PRINTED CIRCUIT BOARD LAYOUT

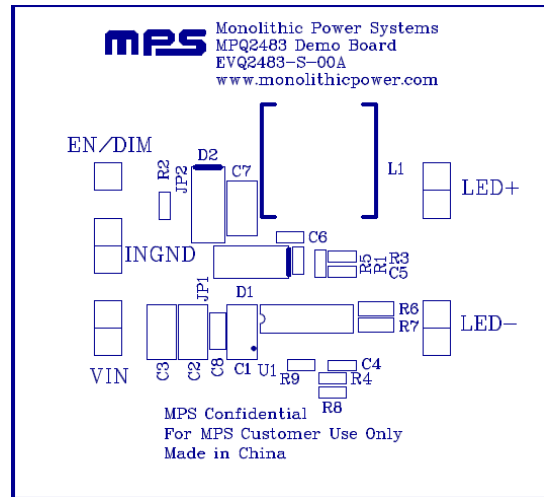
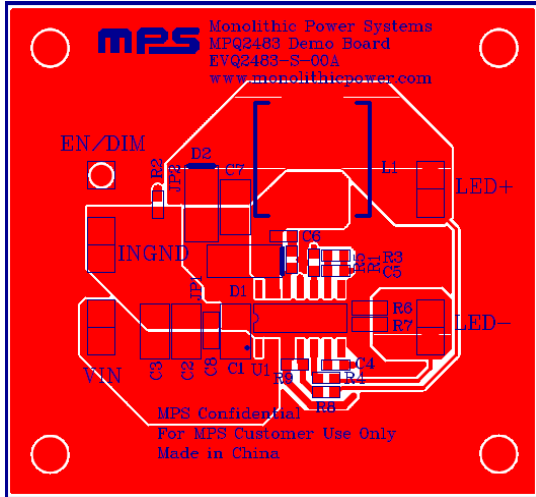

Figure 1—Top Layer

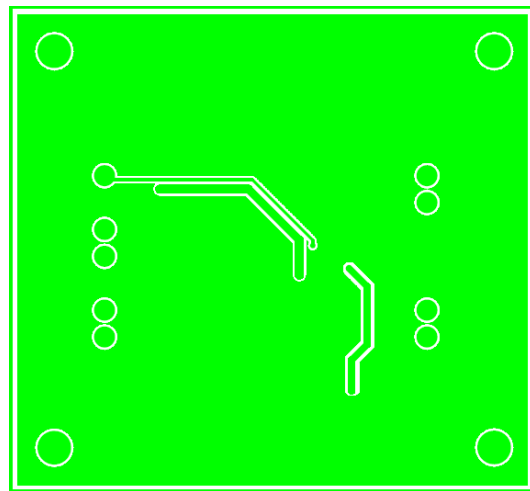
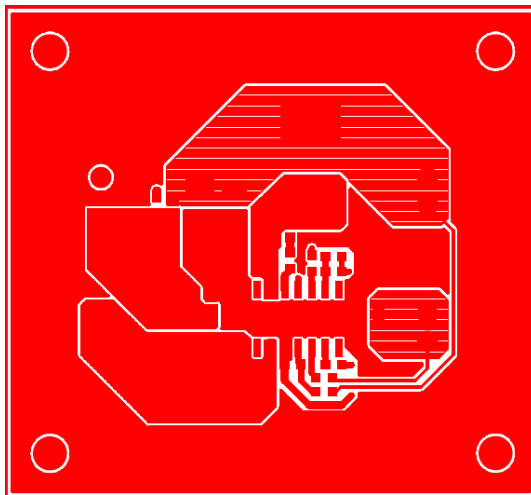

Figure 2—Bottom Layer